

TOLERANCE UNLESS OTHERWISE SPECIFIED	
.X	±0.25
.XX	±0.13
.XXX	±0.10

THIS IS A C.A.D. GENERATED DRAWING  
DO NOT MAKE MANUAL REVISIONS TO MASTER.

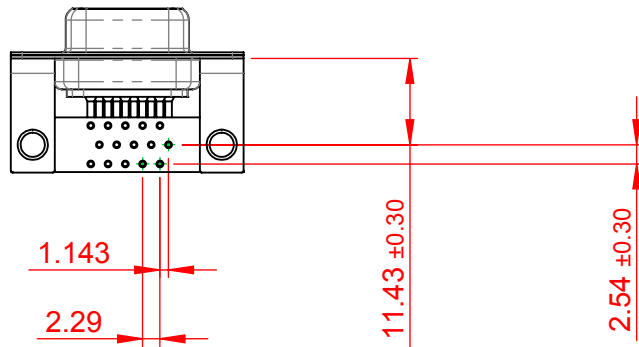

ISSUE NUMBER	
ORIGINAL	①

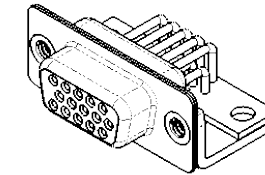
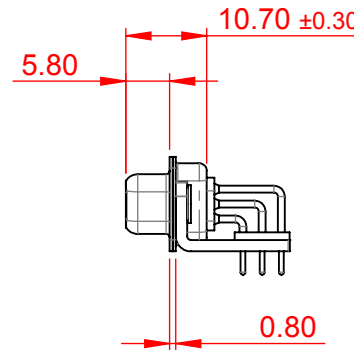
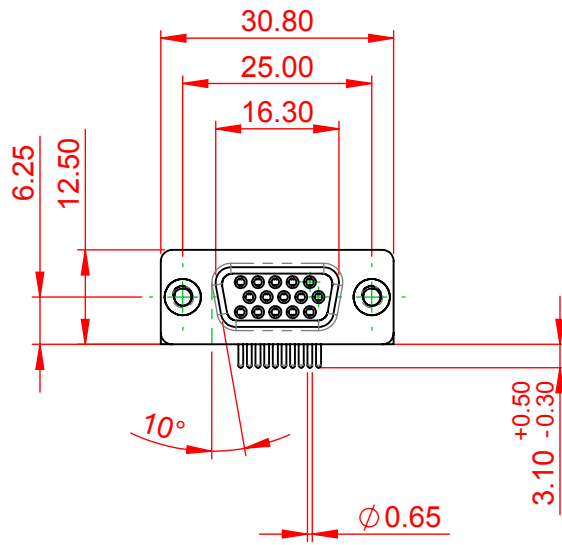

NOTES:

MATERIAL:

HOUSING: PA6T, UL94V-0

SHELL: STEEL, Sn or Ni PLATED

CONTACT: PRECISION MACHINED COPPER ALLOY

SEE ORDERING GUIDE FOR CONTACT PLATING

OPERATING TEMPERATURE: -55°C ~ 125°C

CURRENT RATING: 5A PER CONTACT

CONTACT RESISTANCE: 10mΩ MAX.

INSULATOR RESISTANCE: 5000MΩ min.

DIELECTRIC

WITHSTANDING VOLTAGE: 1000V AC rms



THIS SERIES FULLY CONFORMS TO  
THE EUROPEAN UNION DIRECTIVES  
2011/65/EU FOR RoHS COMPLIANCY.



YOUR CONNECTION TO QUALITY & SERVICE

EDAC INC  
TORONTO, ONTARIO  
CANADA

THESE DRAWINGS AND SPECIFICATIONS  
ARE THE PROPERTY OF EDAC INC., AND  
SHALL NOT BE REPRODUCED, OR COPIED  
OR USED AS THE BASIS FOR THE  
MANUFACTURE OR SALE OF APPARATUS  
WITHOUT WRITTEN PERMISSION.

634M SERIES D-SUB CONNECTOR

SW REFERENCE NO.: 634M ASSEMBLY	
DRAWN: C.B	DATE: AUG. 01/2018
CHECKED:	DATE:
SCALE: 1:1	SHEET 1 OF 1
DRAWING NUMBER: 634-M15-263-BT4	ISSUE
PART NUMBER: 634-M15-263-BT4	1