

Item description

Male connector/plug *WINSTA*® MIDI B coding

The *WINSTA*® MIDI male connector/plug B coding allows installation of solid and fine-stranded conductors. On PCBs, in control cabinets or for connecting lights – pluggable installation connectors from WAGO allow you to make connections according to various requirements in no time flat. For greater security in electrical installations, the pluggable installation connector is provided with mechanical protection against mismatching. The pluggable installation connector is protected against ingress by solid objects in accordance with protection type IP20 (When mated and secured with a strain relief housing: IP2x0 (These compact connectors are not designed for use in open, easily accessible areas!)). Pluggable installation connectors with B coding from the *WINSTA*® MIDI line are available in gray, light green, or pink, allowing you to distinguish different circuits, for example for light, pumps or, sun blinds. Your own pole marking is possible as well. This pluggable installation connector can be used for electrical currents up to 25 A. Thus the product is especially suitable for high power loads. The *WINSTA*® MIDI Pluggable Connection System with Push-in CAGE CLAMP® spring pressure connection technology facilitates exemplary electrification. Thanks to the built-in test slot, it is possible to check connections even when they are plugged in. This saves time, labor, and money.

Subject to changes. Please also observe the further product documentation!



WINSTA® MIDI solutions for your electrical installation – protected against mismatching and maintenance-free

The WINSTA® Pluggable Connection System allows pluggable electrical installation. This saves time, lowers costs, and reduces the need for servicing. Now you can also reduce installation costs without compromising safety and quality: The WINSTA® MIDI pluggable installation connector with protection type IP20 reduces the need for servicing and prevents unnecessary downtime.

- protection against mismatching eliminates errors
- for automation controllers
- for automation controllers
- ready for immediate use
- rapid, structured electrical installation

Data

Notes

Variants:

Other pole markings

Other versions (or variants) can be requested from WAGO Sales or configured at <https://configurator.wago.com/>.

Electrical data

Ratings per IEC/EN

Ratings per	IEC/EN 60664-1
Nominal voltage (III/3)	250 V
Rated impulse voltage (III/3)	4 kV
Rated current	25 A
Legend (ratings)	(III / 3) ≙ Overvoltage category III / Pollution degree 3

Ratings per UL 1977

Note for the US market	Some versions may also be used for current interruption in accordance with the UL certificate in select applications with currents below 16 A and voltages up to 600 V. For further information, please contact your local sales office.
Rated voltage (UL 1977)	600 V
Rated current UL 1977	23 A

Subject to changes. Please also observe the further product documentation!

WAGO GmbH & Co. KG
 Hansastr. 27
 32423 Minden
 Phone: +49571 887-0 | Fax: +49571 887-169
 Email: info.de@wago.com | Web: www.wago.com

Do you have any questions about our products?
 We are always happy to take your call at +49 (571) 887-44222.



General

Note on contact resistance	approx. 1 mΩ of contact resistance approx. 0.25 mΩ contact transition plug/socket
----------------------------	--

Connection data

Connection points	4
Total number of potentials	2

Connection 1

Connection technology	Push-in CAGE CLAMP®
Actuation type	Operating tool Push-in
Nominal cross-section	4 mm ² / 12 AWG
Solid conductor	0.5 ... 4 mm ² / 20 ... 12 AWG
Solid conductor; push-in termination	1.5 ... 4 mm ² / 16 ... 12 AWG
Stranded conductor	0.5 ... 2.5 mm ² / 20 ... 14 AWG
Fine-stranded conductor	0.5 ... 4 mm ² / 20 ... 12 AWG
Fine-stranded conductor; with insulated ferrule	0.25 ... 1.5 mm ² / 20 ... 16 AWG
Fine-stranded conductor; with uninsulated ferrule	0.25 ... 2.5 mm ² / 20 ... 14 AWG
Fine-stranded conductor; with ferrule; push-in termination	1.5 mm ² / 16 AWG
Strip length	9 mm / 0.35 inches
Pole number	2
Conductor entry direction to mating direction	0°

Physical data

Pin spacing	10 mm / 0.394 inches
Width	20 mm / 0.787 inches
Height	12.9 mm / 0.508 inches
Depth	37.5 mm / 1.476 inches

Mechanical Data

Application	Control technology
Coding	B
Variable coding	No
Marking	I- I+
Potential marking	I- I+

Subject to changes. Please also observe the further product documentation!



Mating force of a plug-in connection	approx. 20 ... 70 N (depending on pole number)
Retention force of a plug-in connection	Locked: > 80 N
Unmating force of a plug-in connection	Unlocked: approx. 20 ... 70 N (depending on pole number)
Number of mating cycles	200, without resistive load
Protection type	IP20; When mated and secured with a strain relief housing: IP2xC (These compact connectors are not designed for use in open, easily accessible areas!)

Plug-in connection

Contact type (pluggable connector)	Male connector/plug
Connector (connection type)	for conductor
Mismating protection	Yes
Note on mismating protection	All <i>WINSTA</i> [®] components are 100% protected against mismating when: a.) plugging different numbers of poles b.) plugging while rotated 180 c.) plugging while laterally staggered d.) plugging one pole
Locking lever	Can be retrofitted
Locking of plug-in connection	locking lever
Note on locking system	All connectors for mounted installations (snap-in versions for lighting fixtures or devices, all types of PCB and distribution connectors) are factory-equipped with locking levers to ensure plugs and sockets are securely locked. Additional locking levers are only required for flying leads (plug/socket).

Material Data

Note (material data)	Information on material specifications can be found here
Color	pink
Cover color	gray
Material group	I
Insulation material	Polyamide (PA66)
Flammability class per UL94	V0
Clamping spring material	Chrome-nickel spring steel (CrNi)
Contact material	Copper or copper alloy; surface-treated
Contact plating	Tin
Fire load	0.14 MJ
Weight	6.5 g

Subject to changes. Please also observe the further product documentation!

Environmental requirements

Processing temperature	-5 ... +40 °C
Continuous operating temperature	-35 ... +85 °C
Note on continuous operating temperature	Insulating parts for temperatures ≤ 105 °C

Commercial data

eCl@ss 10.0	27-44-06-05
eCl@ss 9.0	27-44-06-05
ETIM 8.0	EC002560
ETIM 7.0	EC002560
PU (SPU)	100 pcs
Packaging type	box
Country of origin	DE
GTIN	4050821553182
Customs tariff number	85366990990

Environmental Product Compliance

RoHS Compliance Status	Compliant, No Exemption
------------------------	-------------------------

Approvals / Certificates

General approvals

Logo	Approval	Additional Approval Text	Certificate name
	cURus Underwriters Laboratories Inc.	UL 1977	E45171

Counterpart



Item no. 770-282/080-000
Socket; 2-pole; Cod. B; 4,00 mm²; pink

www.wago.com/770-282/080-000

Required accessories

Locking levers

Locking system

Subject to changes. Please also observe the further product documentation!



Item no.: 770-121
Locking lever; for flying leads; for manual operation; white

www.wago.com/770-121



Item no.: 770-131
Locking lever; for flying leads; for tool operation; white

www.wago.com/770-131



Item no.: 770-101
Locking lever; for flying leads; for manual operation; black

www.wago.com/770-101



Item no.: 770-111
Locking lever; for flying leads; for tool operation; black

www.wago.com/770-111

Strain relief

Strain relief housing



Item no.: 770-502/041-000
Strain relief housing; 2-pole; with locking clip; for 1 cable; 7.0 ... 10.5 mm; 35 mm; black

www.wago.com/770-502/041-000



Item no.: 770-502/042-000
Strain relief housing; 2-pole; with locking clip; for 1 cable; 5.0 ... 9.0 mm; 35 mm; black

www.wago.com/770-502/042-000



Item no.: 770-512/041-000
Strain relief housing; 2-pole; with locking clip; for 1 cable; 7.0 ... 10.5 mm; 35 mm; white

www.wago.com/770-512/041-000



Item no.: 770-512/042-000
Strain relief housing; 2-pole; with locking clip; for 1 cable; 5.0 ... 9.0 mm; 35 mm; white

www.wago.com/770-512/042-000

Optional accessories

Mounting

Snap-in frame



Item no.: 770-317
Snap-in frame; 2-pole; 1.0 ... 3.0 mm; black

www.wago.com/770-317



Item no.: 770-337
Snap-in frame; 2-pole; 1.0 ... 3.0 mm; black

www.wago.com/770-337

Mounting accessories

Subject to changes. Please also observe the further product documentation!



Item no.: 897-2100

Mounting plate; for Snap-in; Plastic; for detectors and sensors ; Ø 200 mm; red

www.wago.com/897-2100

Cover

Cover



Item no.: 770-360

Lockout cap; for plugs; 5-pole; separable; yellow

www.wago.com/770-360



Item no.: 897-2003

Protective cap; Type2; for sockets and plugs; PVC; red

www.wago.com/897-2003

Tool

Operating tool



Item no.: 210-719

Operating tool; Blade: 2.5 x 0.4 mm; with a partially insulated shaft

www.wago.com/210-719



Item no.: 770-382

Operating tool; 2-way; green

www.wago.com/770-382

Downloads

Documentation

Bid Text

770-292/080-000 X81 - Datei	2019 Feb 19	xml 3.0 kB	Download
770-292/080-000 doc - Datei	2015 Jun 8	doc 24.6 kB	Download

CAD/CAE-Data

CAD data

2D/3D Models 770-292/080-000	URL	Download
------------------------------	-----	----------

CAE data

EPLAN Data Portal 770-292/080-000	URL	Download
-----------------------------------	-----	----------

Subject to changes. Please also observe the further product documentation!

WSCAD Universe 770-292/080-000	URL	Download
ZUKEN Portal 770-292/080-000	URL	Download
WSCAD Universe 770-292/080-000	URL	Download
EPLAN Data Portal 770-292/080-000	URL	Download

Environmental Product Compliance

Compliance Search

Environmental Product Compliance 770-292/080-000 Plug; 2-pole; Cod. B; 4,00 mm ² ; pink	URL	Download
---	---------------------	--------------------------

Installation Notes

Conductor termination

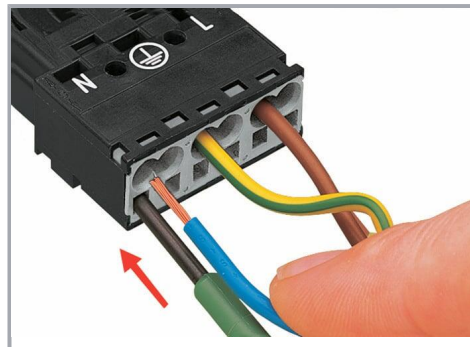
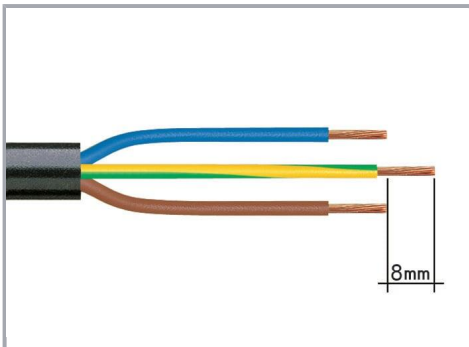

1. Strip length, outer insulation = 35 mm (2-pole), 55 mm (3- to 5-pole)

2. Strip length = 9 mm

3. Extended ground conductor = 8 mm

To terminate fine-stranded conductors, open the clamping unit via screwdriver (2.5 mm blade width) and insert a stripped conductor until it hits the backstop.

Subject to changes. Please also observe the further product documentation!

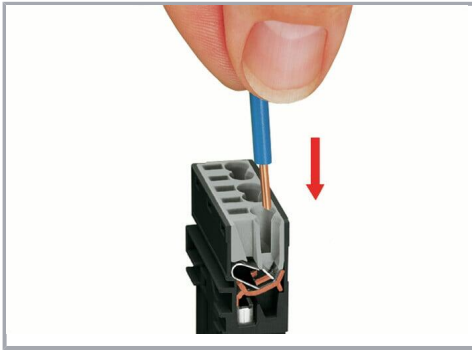

Insert the stripped solid conductor until it hits the backstop.

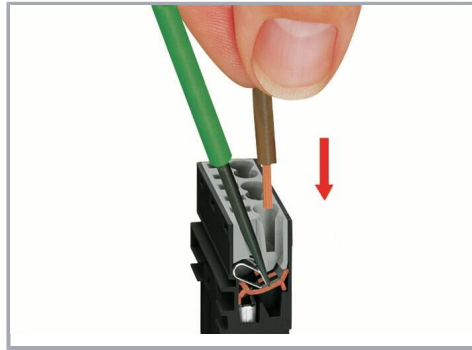

To terminate fine-stranded conductors, open the clamping unit via screwdriver (2.5 mm blade width) and insert a stripped conductor until it hits the backstop.

Conductor removal

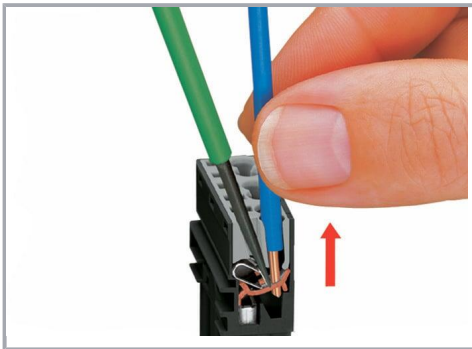

To remove the conductor, actuate the clamp via screwdriver (2.5 mm blade width) and pull out the conductor.

Installation

Subject to changes. Please also observe the further product documentation!

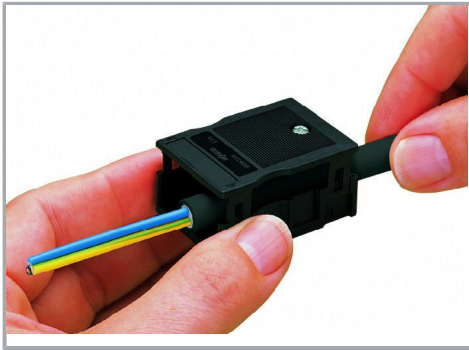

We recommend pulling the pre-latched strain relief housing over the cable prior to termination. However, the strain relief can be mounted at a later time as well.

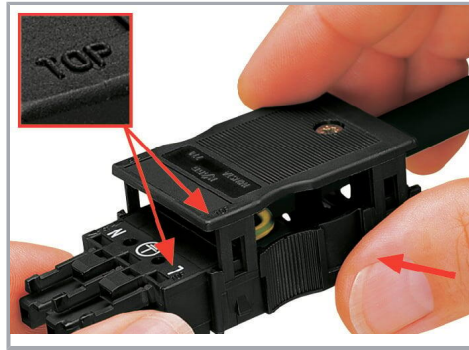

Latch the strain relief housing onto the plug /socket. Note the "TOP" inscription.

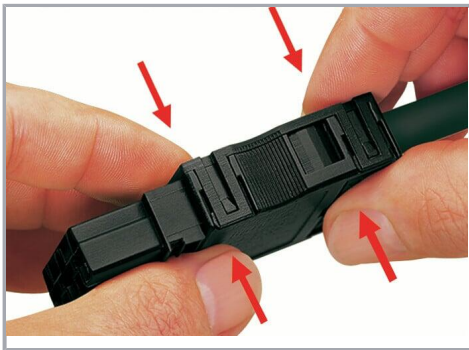

Prepare strain relief housing by snapping together upper and bottom part.



Tighten strain relief screw with screwdriver (2.5 mm blade width).

Coding



Simply cut off the coding pin from the socket.

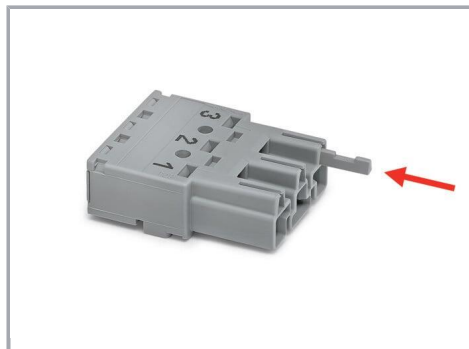

Insert coding pin into plug (break first) until it engages.

Subject to changes. Please also observe the further product documentation!

Mismatching protection

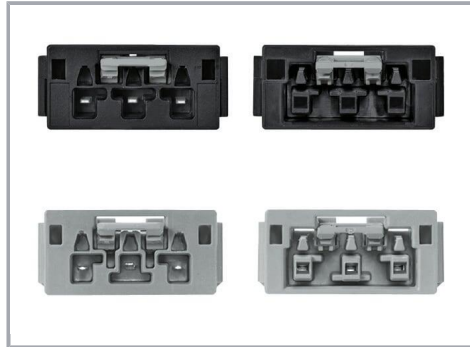
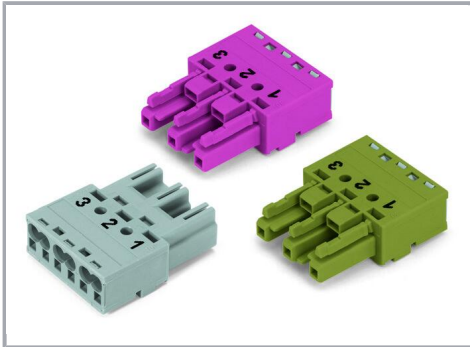

B-coded connectors with different colors can be plugged together.

Important note:

Different colors and/or pole markings are used for circuit identification.

Only connectors of the same color and same pole marking must be plugged together.

B-coded connectors (shown in gray) not only differ in color, but also in their design, making them incompatible with other coded connectors.



Easy circuit identification via different marking and colors

Product family

WINSTA® MIDI

[Show all products from the family](#)

Subject to changes. Please also observe the further product documentation!