

### Product Summary

$V_{(BR)DSS}$	$R_{DS(on)MAX}$	$I_D@25^{\circ}C$
1200V	53mΩ@18V	68A

### Feature

- Higher System Efficiency
- Reduced Cooling Requirements
- Increased Power Density
- Increased System Switching Frequency

### Application

- Renewable Energy
- High Voltage DC/DC Converters
- Switch Mode Power Supplies
- EV Battery Chargers

### Package

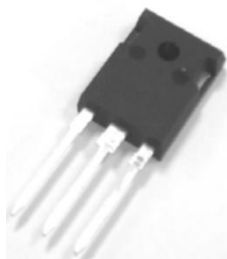

TO-247-3

### Marking



### Circuit diagram

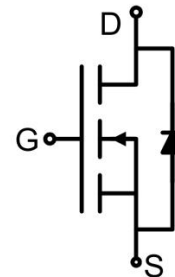

### Absolute maximum ratings ( $T_C=25^{\circ}C$ unless otherwise noted)

Parameter	Symbol	Test Condition	Value	Unit
Drain-Source Voltage	$V_{DSmax}$	$V_{GS} = 0V, I_{DS} = 100\mu A$	1200	V
Gate-Source Voltage	$V_{GSmax}$	Absolute maximum values	-8/+22	V
Gate-Source Voltage	$V_{GSOP}$	Recommended operational values	-4/+18	V
Continuous Drain Current	$I_D$	$V_{GS} = 18V, T_C=25^{\circ}C$	68	A
	$I_D$	$V_{GS} = 18V, T_C=100^{\circ}C$	49	A
Pulsed Drain Current	$I_{D(pulse)}$	Pulse width $t_p$ limited by $T_{jmax}$	100	A
Power Dissipation	$P_D$	$T_C=25^{\circ}C, T_j=175^{\circ}C$	340	W
Thermal Resistance	$R_{\theta JC}$	Junction-to-Case (Typ.)	0.44	$^{\circ}C/W$
Thermal Resistance	$R_{\theta JA}$	Junction-to-Ambient	40	$^{\circ}C/W$
Junction Temperature	$T_J$		-55 ~ +175	$^{\circ}C$
Storage Temperature	$T_{STG}$		-55 ~ +175	$^{\circ}C$

### Electrical characteristics (T<sub>C</sub>=25 °C, unless otherwise noted)

Parameter	Symbol	Test Condition	Min.	Typ.	Max.	Unit
<b>Static Characteristics</b>						
Drain-source breakdown voltage	V <sub>(BR)DSS</sub>	V <sub>GS</sub> = 0V, I <sub>DS</sub> = 100uA	1200			V
Zero gate voltage drain current	I <sub>DSS</sub>	V <sub>DS</sub> = 1200V, V <sub>GS</sub> = 0V			100	μA
Gate-Source leakage current	I <sub>GSS+</sub>	V <sub>GS</sub> = 22V, V <sub>DS</sub> = 0V			250	nA
Gate-Source leakage current	I <sub>GSS-</sub>	V <sub>GS</sub> = -8V, V <sub>DS</sub> = 0V			250	nA
Gate threshold voltage	V <sub>GS(th)</sub>	V <sub>DS</sub> = V <sub>GS</sub> , I <sub>DS</sub> = 9.5mA	1.9	2.6	4.0	V
		V <sub>DS</sub> = V <sub>GS</sub> , I <sub>DS</sub> = 9.5mA, T <sub>J</sub> = 175°C		1.8		
Drain-source on-resistance	R <sub>DS(on)</sub>	V <sub>GS</sub> = 18V, I <sub>D</sub> = 33.3A		40	53	mΩ
		V <sub>GS</sub> = 18V, I <sub>D</sub> = 33.3A, T <sub>J</sub> = 175°C		65		
Transconductance	g <sub>fs</sub>	V <sub>DS</sub> = 20V, I <sub>D</sub> = 33.3A		21		S
		V <sub>DS</sub> = 20V, I <sub>D</sub> = 33.3A, T <sub>J</sub> = 175°C		17.5		
<b>Dynamic characteristics</b>						
Input Capacitance	C <sub>iss</sub>	V <sub>DS</sub> = 1000V, V <sub>GS</sub> = 0V, f = 1MHz V <sub>AC</sub> = 25mV		2070		pF
Output Capacitance	C <sub>oss</sub>			112		
Reverse Transfer Capacitance	C <sub>rss</sub>			11		
C <sub>oss</sub> Stored Energy	E <sub>oss</sub>			66		
Turn-on Switching Energy	E <sub>on</sub>	V <sub>DS</sub> = 800V, V <sub>GS</sub> = -4V/18V, I <sub>D</sub> = 33A, R <sub>G(ext)</sub> = 2.5Ω, L = 100μH		1410		μJ
Turn-off Switching Energy	E <sub>off</sub>			750		
Total Gate Charge	Q <sub>g</sub>	V <sub>DS</sub> = 800V, V <sub>GS</sub> = -4V/18V, I <sub>D</sub> = 33A		121		nC
Gate-Source Charge	Q <sub>gs</sub>			34		
Gate-Drain Charge	Q <sub>gd</sub>			20		
Turn-on delay time	t <sub>d(on)</sub>	V <sub>DS</sub> = 800V, V <sub>GS</sub> = -4V/18V, I <sub>D</sub> = 33A, R <sub>G(ext)</sub> = 2.5Ω, R <sub>L</sub> = 20Ω		17		nS
Turn-on rise time	t <sub>r</sub>			58		
Turn-off delay time	t <sub>d(off)</sub>			26		
Turn-off fall time	t <sub>f</sub>			15		
Internal Gate Resistance	R <sub>G</sub>	f = 1MHz V <sub>AC</sub> = 25mV		4.9		Ω
<b>Source-Drain Diode characteristics</b>						
Diode Forward Current	I <sub>S</sub>	T <sub>C</sub> = 25°C			51	A
Diode Forward voltage	V <sub>SD</sub>	V <sub>GS</sub> = -4V, I <sub>SD</sub> = 10A		4.5		V
		V <sub>GS</sub> = -4V, I <sub>SD</sub> = 10A, T <sub>J</sub> = 175°C		4.2		
Reverse Recovery Time	t <sub>rr</sub>	I <sub>SD</sub> = 20A, V <sub>R</sub> = 800V		38		nS
Reverse Recovery Charge	Q <sub>rr</sub>			109		nC
Peak Reverse Recovery Current	I <sub>rrm</sub>				5	

## Typical Characteristics

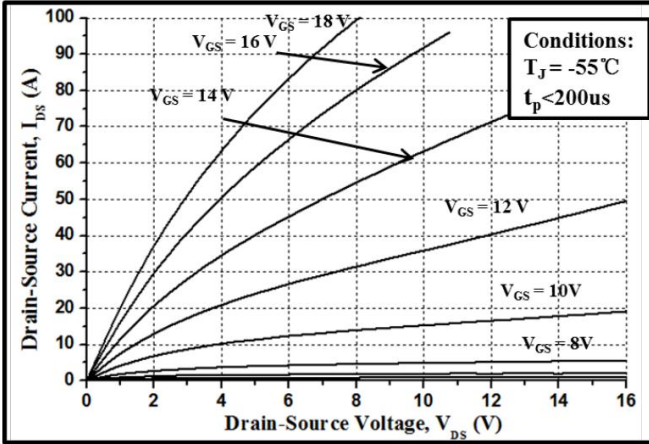

Figure 1. Output Characteristics  $T_J = -55^\circ\text{C}$

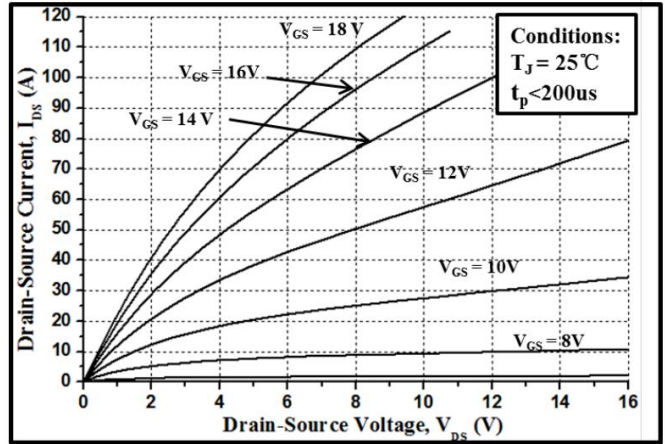

Figure 2. Output Characteristics  $T_J = 25^\circ\text{C}$

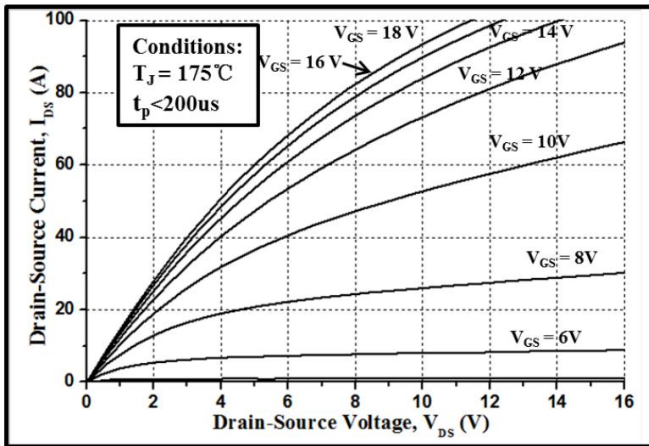

Figure 3. Output Characteristics  $T_J = 175^\circ\text{C}$

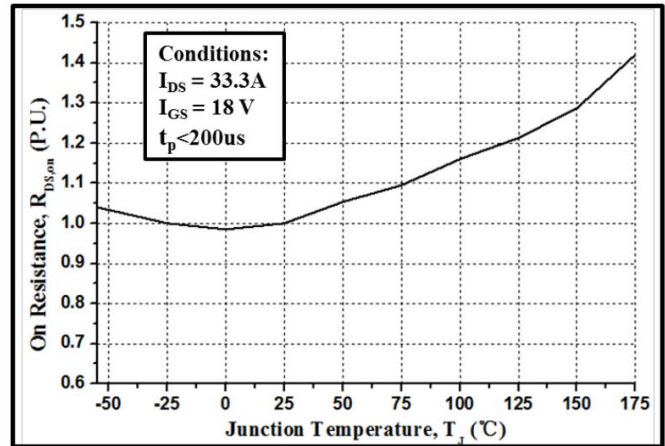

Figure 4. Normalized On-Resistance vs. Temperature

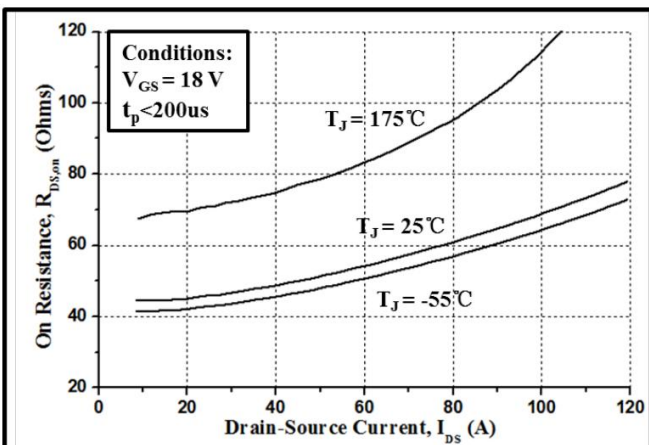

Figure 5. On-Resistance vs. Drain Current  
For Various Temperatures

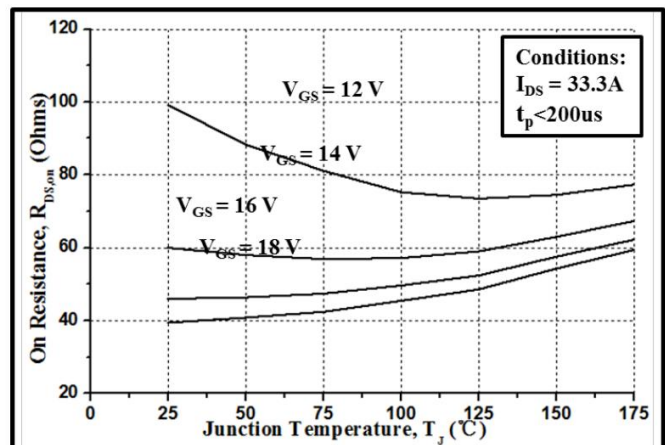

Figure 6. On-Resistance vs. Temperature  
For Various Gate Voltage

## Typical Characteristics

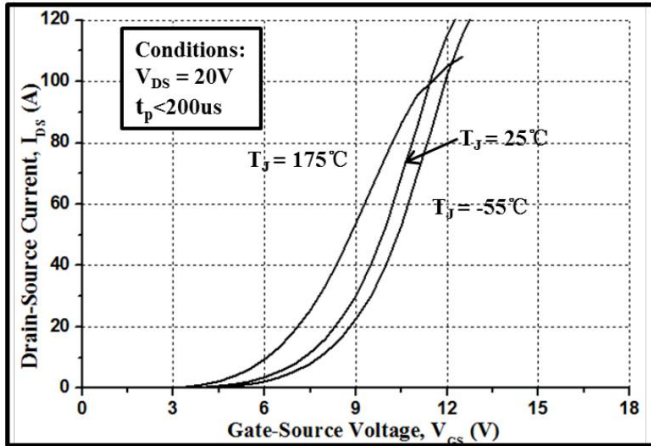

Figure 7. Transfer Characteristic for Various Junction Temperatures

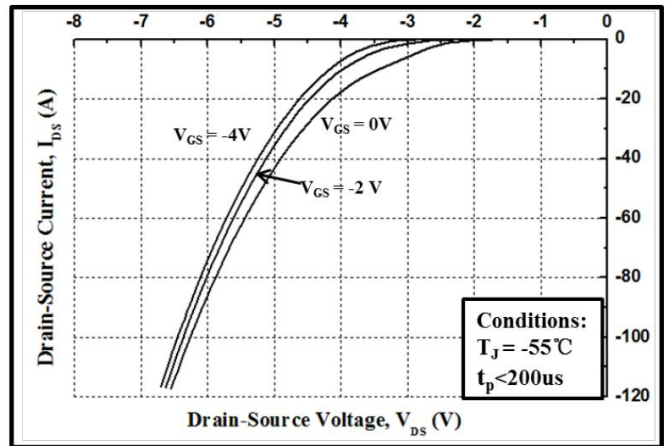

Figure 8. Body Diode Characteristic at -55°C

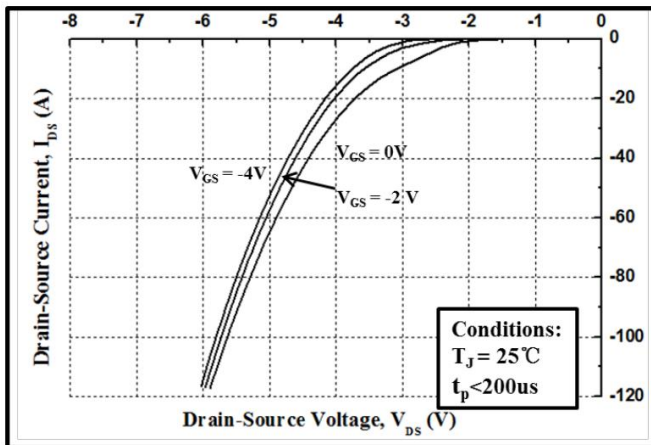

Figure 9. Body Diode Characteristic at 25°C

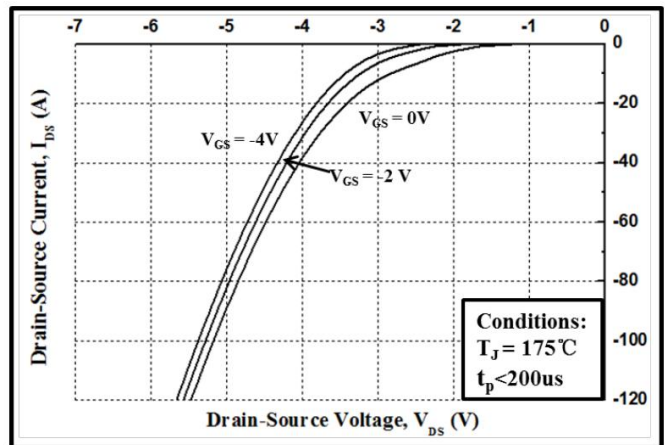

Figure 10. Body Diode Characteristic at 175°C

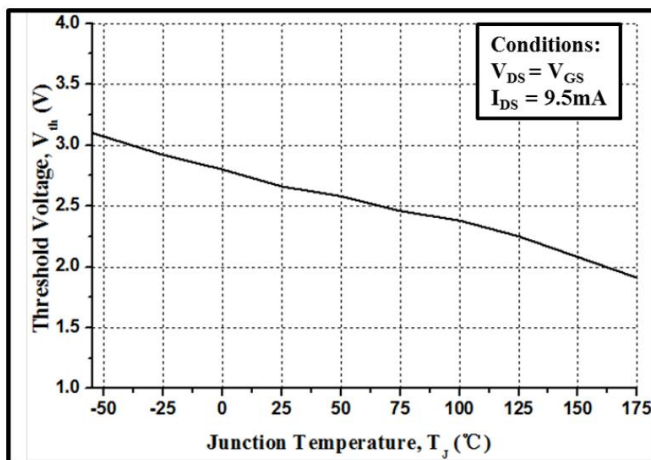

Figure 11. Threshold Voltage vs. Temperature

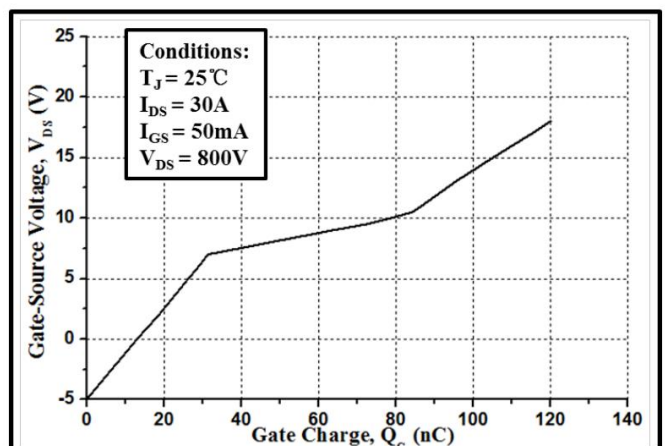

Figure 12. Gate Charge Characteristics



## Typical Characteristics

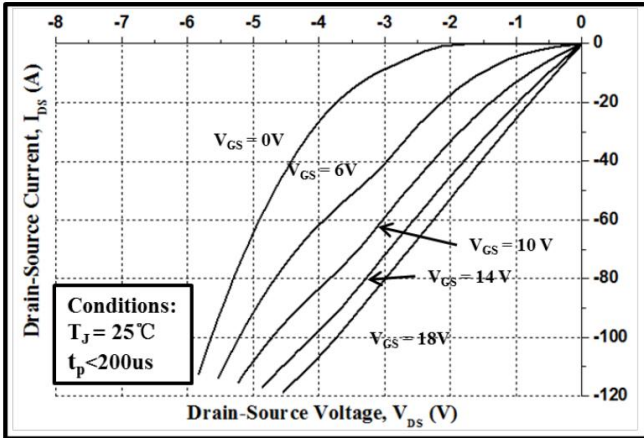

Figure 13. 3rd Quadrant Characteristic at 25°C

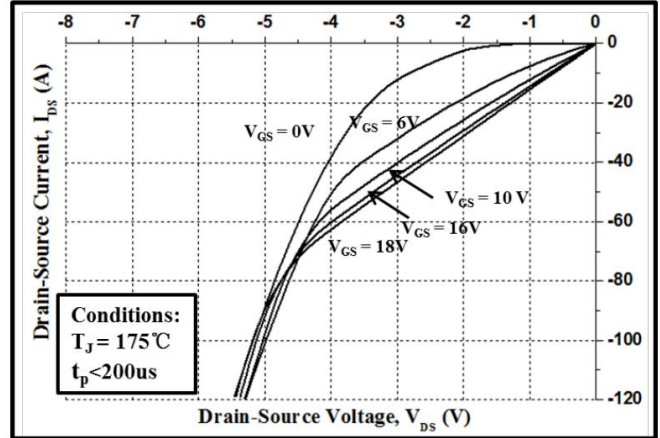

Figure 14. 3rd Quadrant Characteristic at 175°C

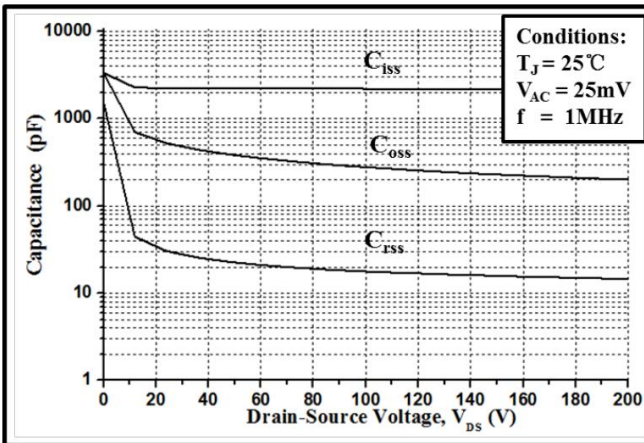

Figure 15. Capacitances vs. Drain-Source Voltage (0 - 200V)

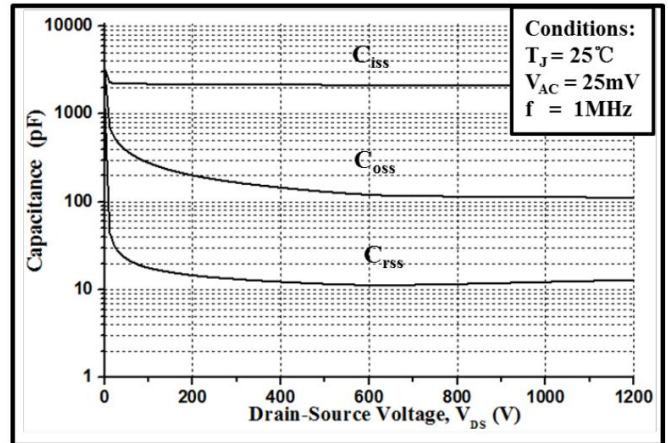
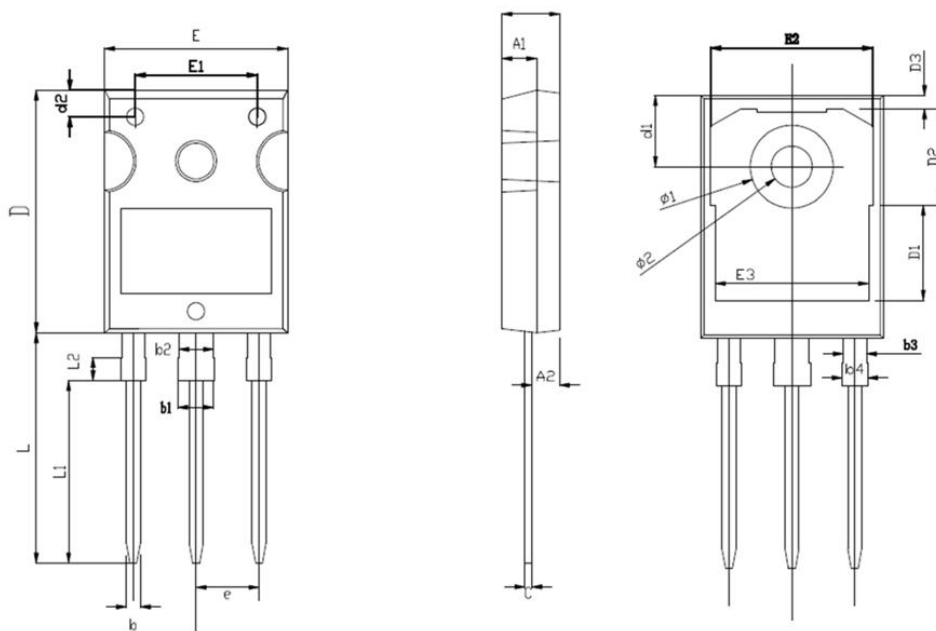

Figure 16. Capacitances vs. Drain-Source Voltage (0 - 1200V)

### TO-247-3 Package Information



Symbol	Dimensions In Millimeters		Dimensions In Inches	
	Min.	Max.	Min.	Max.
A	4.800	5.250	0.189	0.207
A1	2.800	3.200	0.110	0.126
A2	2.260	2.560	0.088	0.100
b	1.050	1.350	0.041	0.053
b1	2.850	3.400	0.112	0.134
b2	2.900	3.100	0.114	0.122
b3	1.900	2.420	0.075	0.095
b4	2.000	2.200	0.078	0.087
c	0.500	0.700	0.019	0.028
D	20.800	21.200	0.818	0.835
D1	8.230 TYP.		0.324 TYP.	
D2	8.320 TYP.		0.327 TYP.	
D3	1.170 TYP.		0.046 TYP.	
E	15.600	16.000	0.614	0.630
E1	10.500 TYP.		0.413 TYP.	
E2	14.020 TYP.		0.552 TYP.	
E3	13.500 TYP.		0.531 TYP.	
L	19.720	20.350	0.776	0.801
L1	15.790 TYP.		0.622 TYP.	
L2	1.980 TYP.		0.078 TYP.	
Φ1	7.180 TYP.		0.283 TYP.	
Φ2	3.600 TYP.		0.142 TYP.	
e	5.440 TYP.		0.214 TYP.	