

MOSFET - Power, Single N-Channel, TOLL

60 V, 0.75 mΩ, 470 A

NVBL50D7N06C

Features

- Low $R_{DS(on)}$ to Minimize Conduction Losses
- Low Q_G and Capacitance to Minimize Driver Losses
- Lowers Switching Noise/EMI
- AEC-Q101 Qualified and PPAP Capable
- These Devices are Pb-Free, Halogen Free/BFR Free and are RoHS Compliant

MAXIMUM RATINGS ($T_J = 25^\circ\text{C}$ unless otherwise noted)

Parameter	Symbol	Value	Unit
Drain-to-Source Voltage	V_{DSS}	60	V
Gate-to-Source Voltage	V_{GS}	± 20	V
Continuous Drain Current $R_{\theta JC}$ (Note 2)	Steady State	$T_C = 25^\circ\text{C}$	I_D 470 A
		$T_C = 100^\circ\text{C}$	332
Power Dissipation $R_{\theta JC}$ (Note 2)	Steady State	$T_C = 25^\circ\text{C}$	P_D 314 W
		$T_C = 100^\circ\text{C}$	157
Continuous Drain Current $R_{\theta JA}$ (Notes 1, 2)	Steady State	$T_A = 25^\circ\text{C}$	I_D 54 A
		$T_A = 100^\circ\text{C}$	38
Power Dissipation $R_{\theta JA}$ (Notes 1, 2)	Steady State	$T_A = 25^\circ\text{C}$	P_D 4.2 W
		$T_A = 100^\circ\text{C}$	2.1
Pulsed Drain Current	$T_A = 25^\circ\text{C}, t_p = 10 \mu\text{s}$	I_{DM} 900	A
Operating Junction and Storage Temperature Range	T_J, T_{stg}	-55 to +175	$^\circ\text{C}$
Source Current (Body Diode)	I_S	260	A
Single Pulse Drain-to-Source Avalanche Energy ($I_{L(pk)} = 40 \text{ A}$)	E_{AS}	800	mJ
Lead Temperature Soldering Reflow for Soldering Purposes (1/8" from case for 10 s)	T_L	260	$^\circ\text{C}$

Stresses exceeding those listed in the Maximum Ratings table may damage the device. If any of these limits are exceeded, device functionality should not be assumed, damage may occur and reliability may be affected.

THERMAL RESISTANCE MAXIMUM RATINGS

Parameter	Symbol	Value	Unit
Junction-to-Case - Steady State (Note 2)	$R_{\theta JC}$	0.48	$^\circ\text{C}/\text{W}$
Junction-to-Ambient - Steady State (Note 2)	$R_{\theta JA}$	36	

1. Surface-mounted on FR4 board using a 1 in² pad size, 2 oz. Cu pad.
2. The entire application environment impacts the thermal resistance values shown, they are not constants and are only valid for the particular conditions noted.

$V_{(BR)DSS}$	$R_{DS(ON) MAX}$	$I_D MAX$
60 V	0.75 mΩ @ 10 V	470 A

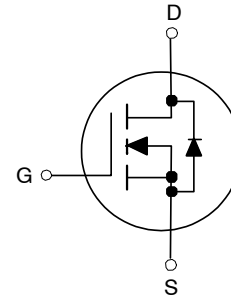

H-PSOF8L
CASE 100CU

ORDERING INFORMATION

Device	Package	Shipping [†]
NVBL50D7N06C	H-PSOF8L (Pb-Free)	2000 / Tape & Reel

[†]For information on tape and reel specifications, including part orientation and tape sizes, please refer to our Tape and Reel Packaging Specification Brochure, BRD8011/D.

NVBLS0D7N06C

Table 1. ELECTRICAL CHARACTERISTICS ($T_J = 25^\circ\text{C}$ unless otherwise noted)

Parameter	Symbol	Test Conditions	Min	Typ	Max	Units
OFF CHARACTERISTICS						
Drain-to-Source Breakdown Voltage	$V_{(BR)DSS}$	$I_D = 250 \mu\text{A}, V_{GS} = 0 \text{ V}$	60			V
Drain-to-Source Breakdown Voltage Temperature Coefficient	$V_{(BR)DSS}/T_J$	$I_D = 661 \mu\text{A}, \text{ref to } 25^\circ\text{C}$		26.5		mV/ $^\circ\text{C}$
Zero Gate Voltage Drain Current	I_{DSS}	$V_{DS} = 60 \text{ V}, V_{GS} = 0 \text{ V}$	$T_J = 25^\circ\text{C}$		10	μA
			$T_J = 125^\circ\text{C}$		100	μA
Gate-to-Source Leakage Current	I_{GSS}	$V_{DS} = 0 \text{ V}, V_{GS} = 20 \text{ V}$			100	nA

ON CHARACTERISTICS (Note 3)

Gate Threshold Voltage	$V_{GS(th)}$	$V_{GS} = V_{DS}, I_D = 661 \mu\text{A}$	2.0	2.8	4.0	V
Negative Threshold Temperature Coefficient	$V_{GS(th)}/T_J$	$I_D = 661 \mu\text{A}, \text{ref to } 25^\circ\text{C}$		9.8		mV/ $^\circ\text{C}$
Drain-to-Source On Resistance	$R_{DS(on)}$	$V_{GS} = 10 \text{ V}, I_D = 80 \text{ A}$		0.56	0.75	m Ω
Forward Transconductance	g_{FS}	$V_{DS} = 10 \text{ V}, I_D = 80 \text{ A}$		310		S

CHARGES & CAPACITANCES

Input Capacitance	C_{iss}	$V_{GS} = 0 \text{ V}, V_{DS} = 30 \text{ V}, f = 10 \text{ kHz}$		13730		pF
Output Capacitance	C_{oss}			6912		pF
Reverse Transfer Capacitance	C_{rss}			92		pF
Total Gate Charge	$Q_{G(tot)}$	$V_{GS} = 10 \text{ V}, V_{DS} = 30 \text{ V}, I_D = 80 \text{ A}$		170		nC
Threshold Gate Charge	$Q_{G(th)}$			39		nC
Gate-to-Source Charge	Q_{gs}			62		nC
Gate-to-Drain Charge	Q_{gd}			16		nC

SWITCHING CHARACTERISTICS, $V_{GS} = 10 \text{ V}$ (Note 3)

Turn-On Delay Time	$t_{d(on)}$	$V_{GS} = 10 \text{ V}, V_{DS} = 30 \text{ V}, I_D = 80 \text{ A}, R_G = 6 \Omega$		37		ns
Rise Time	t_r			57		ns
Turn-Off Delay Time	$t_{d(off)}$			146		ns
Fall Time	t_f			105		ns

DRAIN-SOURCE DIODE CHARACTERISTICS

Forward Diode Voltage	V_{SD}	$I_S = 80 \text{ A}, V_{GS} = 0 \text{ V}$	$T_J = 25^\circ\text{C}$		0.79	1.2	V
		$I_S = 80 \text{ A}, V_{GS} = 0 \text{ V}$	$T_J = 125^\circ\text{C}$		0.66		V
Reverse Recovery Time	t_{rr}	$V_{GS} = 0 \text{ V}, di_S/dt = 100 \text{ A}/\mu\text{s}, I_S = 66 \text{ A}$		132		ns	
Charge Time	t_a			64		ns	
Discharge Time	t_b			68		ns	
Reverse Recovery Charge	Q_{rr}			386		nC	

Product parametric performance is indicated in the Electrical Characteristics for the listed test conditions, unless otherwise noted. Product performance may not be indicated by the Electrical Characteristics if operated under different conditions.

3. Switching characteristics are independent of operating junction temperatures

TYPICAL CHARACTERISTICS

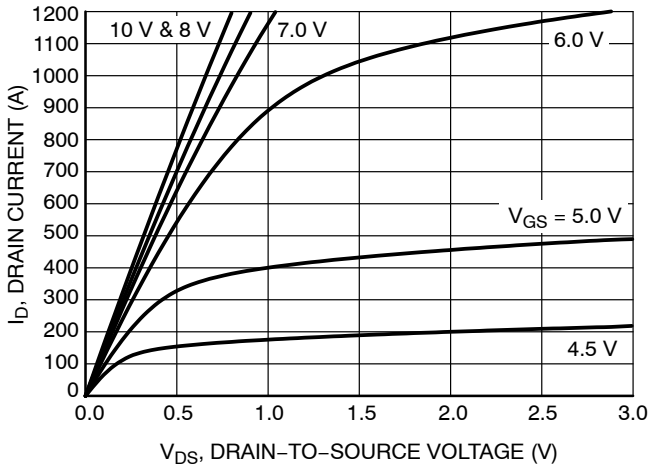

Figure 1. On-Region Characteristics

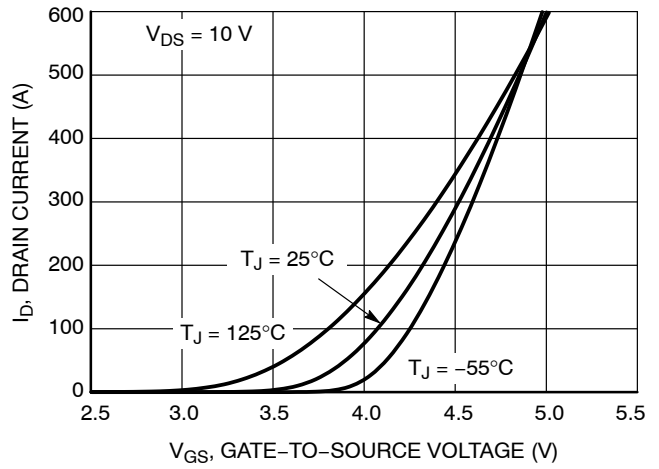

Figure 2. Transfer Characteristics

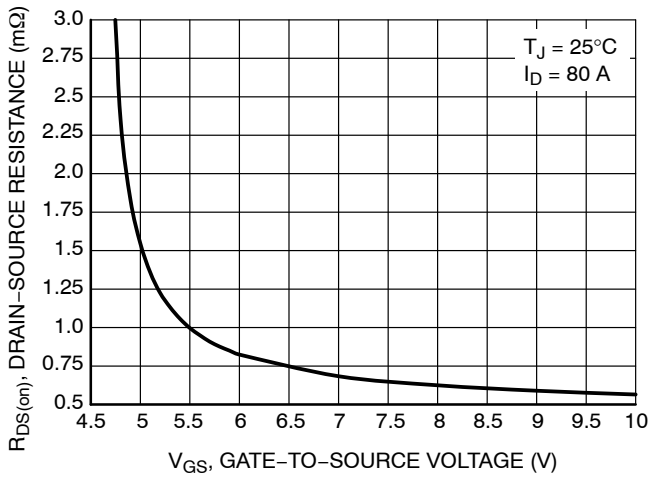

Figure 3. On-Resistance vs. V_{GS}

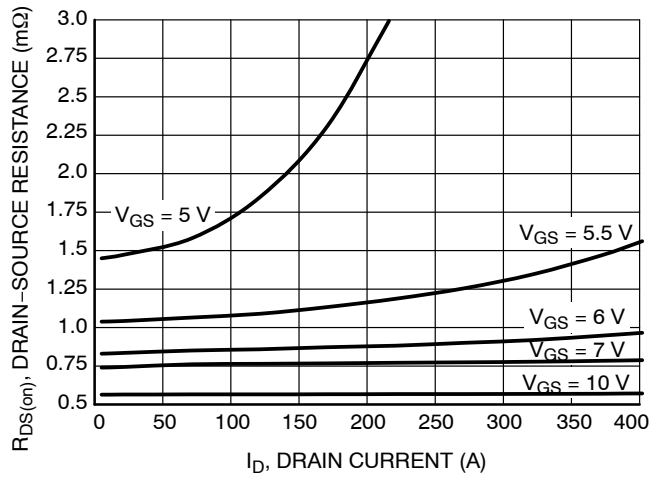

Figure 4. On-Resistance vs. Drain Current and Gate Voltage

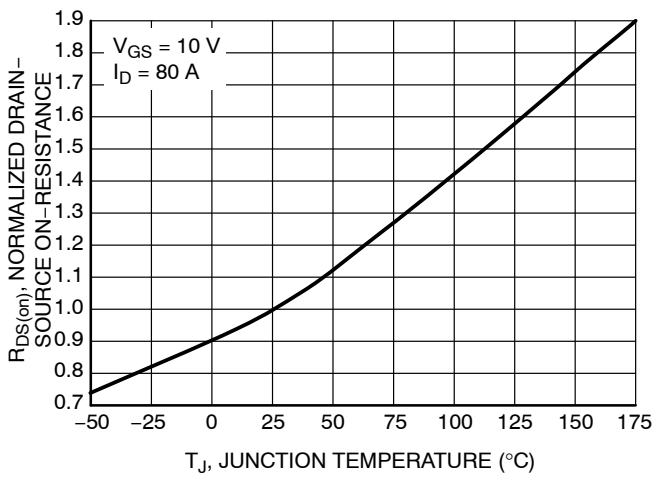

Figure 5. On-Resistance Variation with Temperature

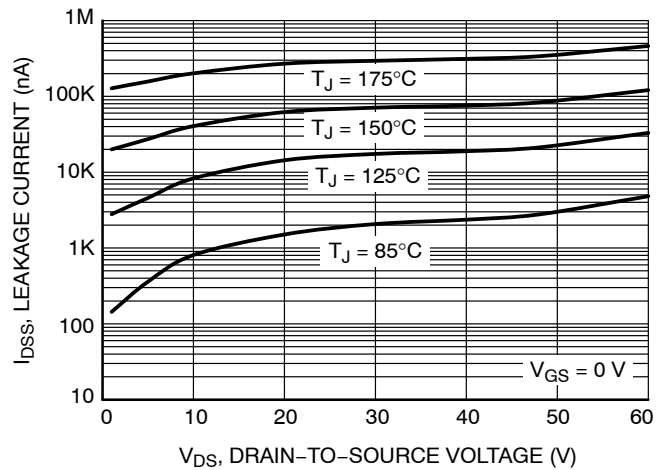

Figure 6. Drain-to-Source Leakage Current vs. Voltage

NVBLS0D7N06C

TYPICAL CHARACTERISTICS

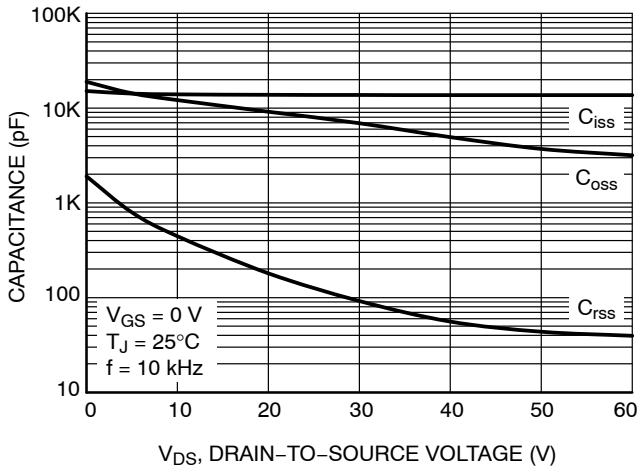

Figure 7. Capacitance Variation

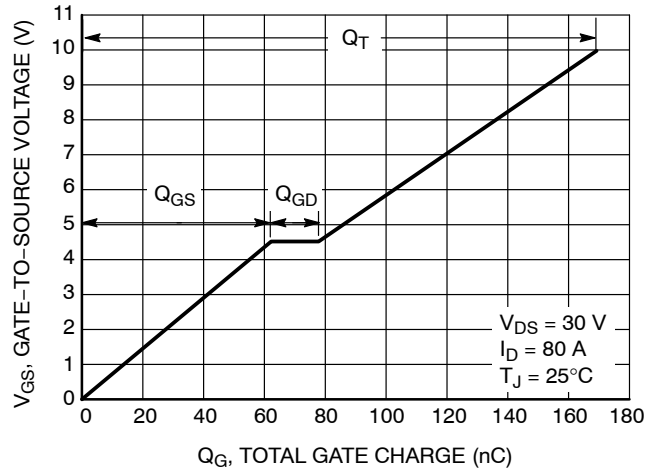

Figure 8. Gate-to-Source Voltage vs. Total Gate Charge

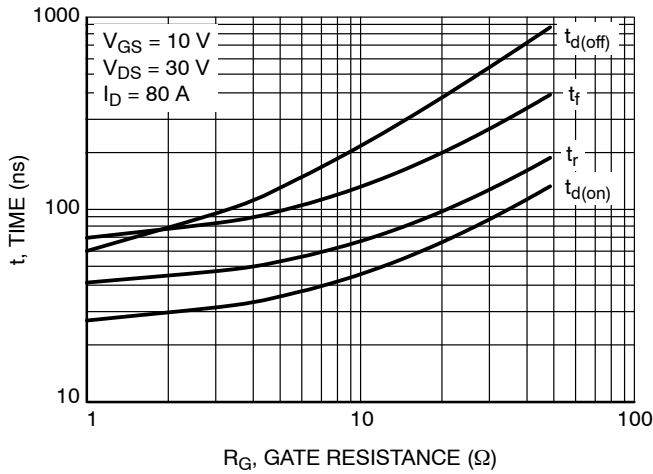

Figure 9. Resistive Switching Time Variation vs. Gate Resistance

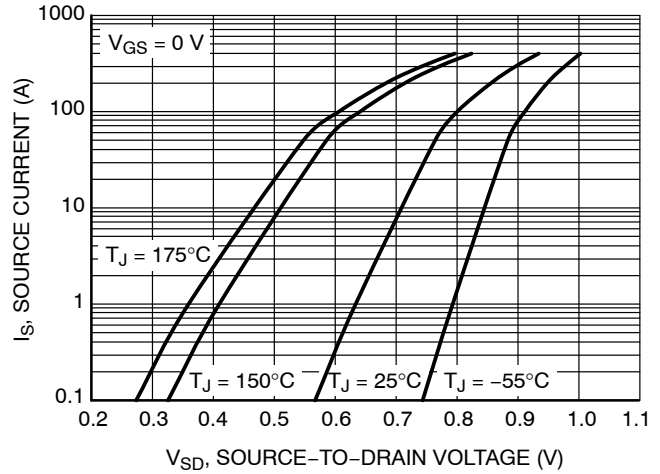

Figure 10. Diode Forward Voltage vs. Current

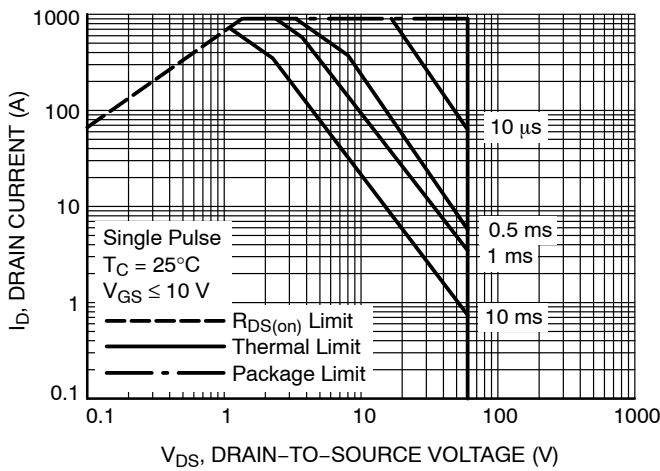

Figure 11. Maximum Rated Forward Biased Safe Operating Area

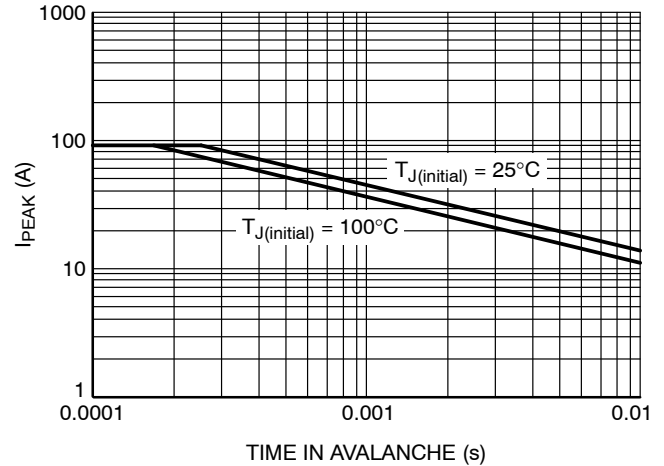

Figure 12. I_{PEAK} vs. Time in Avalanche

NVBLS0D7N06C

TYPICAL CHARACTERISTICS

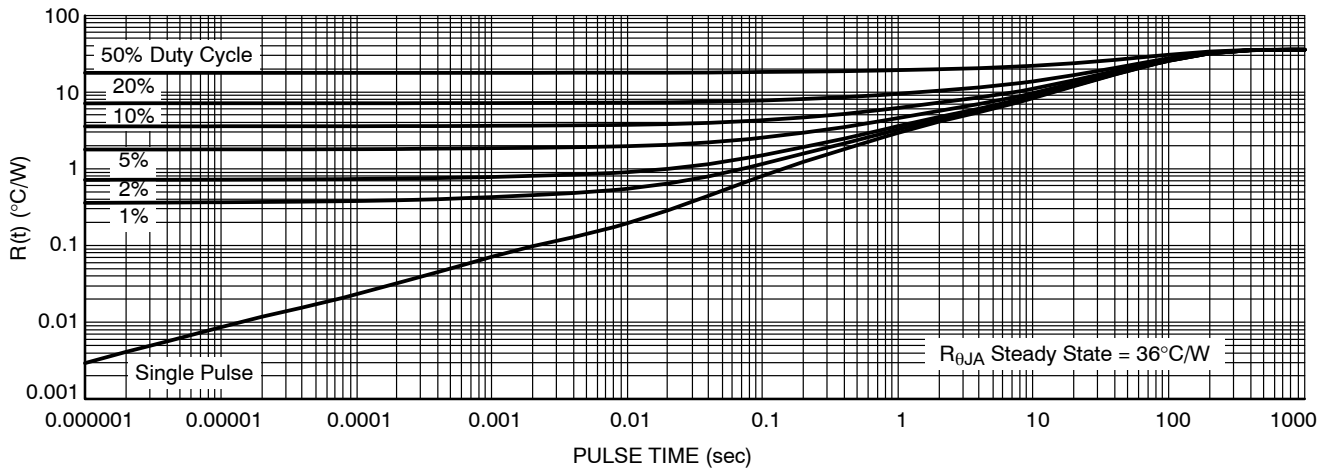
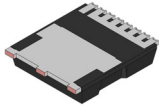

Figure 13. Thermal Characteristics (Junction-to-Ambient)

MECHANICAL CASE OUTLINE PACKAGE DIMENSIONS



H-PSOF8L 11.68x9.80
CASE 100CU
ISSUE C

DATE 22 MAY 2023

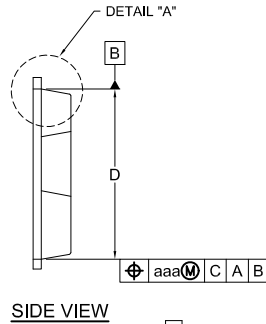

LAND PATTERN RECOMMENDATION

*FOR ADDITIONAL INFORMATION ON OUR PB-FREE STRATEGY AND SOLDERING DETAILS, PLEASE DOWNLOAD THE ON SEMICONDUCTOR SOLDERING AND MOUNTING TECHNIQUES REFERENCE MANUAL, SOLDERRM/D.

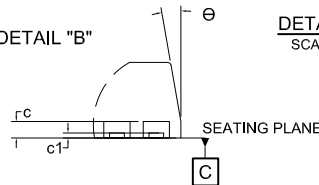

DETAIL "A"
SCALE: 2X

NOTES:

1. PACKAGE STANDARD REFERENCE: JEDEC MO-299, ISSUE A.
2. DIMENSIONING AND TOLERANCING PER ASME Y14.5M, 2009.
3. CONTROLLING DIMENSION: MILLIMETERS.
4. COPLANARITY APPLIES TO THE EXPOSED WELL AS THE TERMINALS.
5. DIMENSIONS D1 AND E1 DO NOT INCLUDE MOLD FLASH, PROTRUSIONS, OR GATE BURRS.
6. SEATING PLANE IS DEFINED BY THE TERMINALS. "A1" IS DEFINED AS THE DISTANCE FROM THE SEATING PLANE TO THE LOWEST POINT ON THE PACKAGE BODY.

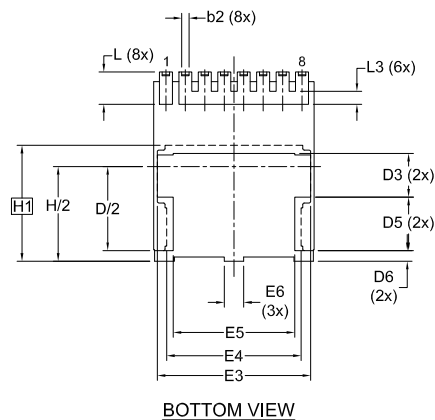

DETAIL "B"
SCALE: 2X

GENERIC MARKING DIAGRAM*

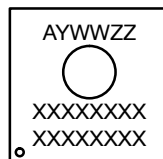

A = Assembly Location
Y = Year
WW = Work Week
ZZ = Assembly Lot Code
XXXX = Specific Device Code

DIM	MILLIMETERS		
	MIN.	NOM.	MAX.
A	2.20	2.30	2.40
A1	1.70	1.80	1.90
b	0.70	0.80	0.90
b1	9.70	9.80	9.90
b2	0.35	0.45	0.55
c	0.40	0.50	0.60
c1	0.10	—	—
D	10.28	10.38	10.48
D/2	5.09	5.19	5.29
D1	10.98	11.08	11.18
D2	3.20	3.30	3.40
D3	2.60	2.70	2.80
D4	4.45	4.55	4.65
D5	3.20	3.30	3.40
D6	0.55	0.65	0.75
E	9.80	9.90	10.00
E1	7.30	7.40	7.50
E2	0.30	0.40	0.50
E3	9.36	9.46	9.56

DIM	MILLIMETERS		
	MIN.	NOM.	MAX.
E4	8.20	8.30	8.40
E5	7.40	7.50	7.60
E6	1.10	1.20	1.30
e	1.20 BSC		
e/2	0.60 BSC		
e1	8.40 BSC		
H	11.58	11.68	11.78
H/2	5.74	5.84	5.94
H1	7.15 BSC		
L	1.90	2.00	2.10
L1	0.60	0.70	0.80
L2	0.50	0.60	0.70
L3	0.70	0.80	0.90
theta	0°	—	12°
aaa	0.20		
bbb	0.25		
ccc	0.20		
ddd	0.20		
eee	0.10		

*This information is generic. Please refer to device data sheet for actual part marking. Pb-Free indicator, "G" or microdot "a", may or may not be present. Some products may not follow the Generic Marking.

DOCUMENT NUMBER:	98AON13813G	Electronic versions are uncontrolled except when accessed directly from the Document Repository. Printed versions are uncontrolled except when stamped "CONTROLLED COPY" in red.
DESCRIPTION:	H-PSOF8L 11.68x9.80	PAGE 1 OF 1

onsemi and ONSEMI are trademarks of Semiconductor Components Industries, LLC dba onsemi or its subsidiaries in the United States and/or other countries. onsemi reserves the right to make changes without further notice to any products herein. onsemi makes no warranty, representation or guarantee regarding the suitability of its products for any particular purpose, nor does onsemi assume any liability arising out of the application or use of any product or circuit, and specifically disclaims any and all liability, including without limitation special, consequential or incidental damages. onsemi does not convey any license under its patent rights nor the rights of others.

onsemi, **Onsemi**, and other names, marks, and brands are registered and/or common law trademarks of Semiconductor Components Industries, LLC dba "**onsemi**" or its affiliates and/or subsidiaries in the United States and/or other countries. **onsemi** owns the rights to a number of patents, trademarks, copyrights, trade secrets, and other intellectual property. A listing of **onsemi**'s product/patent coverage may be accessed at www.onsemi.com/site/pdf/Patent-Marking.pdf. **onsemi** reserves the right to make changes at any time to any products or information herein, without notice. The information herein is provided "as-is" and **onsemi** makes no warranty, representation or guarantee regarding the accuracy of the information, product features, availability, functionality, or suitability of its products for any particular purpose, nor does **onsemi** assume any liability arising out of the application or use of any product or circuit, and specifically disclaims any and all liability, including without limitation special, consequential or incidental damages. Buyer is responsible for its products and applications using **onsemi** products, including compliance with all laws, regulations and safety requirements or standards, regardless of any support or applications information provided by **onsemi**. "Typical" parameters which may be provided in **onsemi** data sheets and/or specifications can and do vary in different applications and actual performance may vary over time. All operating parameters, including "Typicals" must be validated for each customer application by customer's technical experts. **onsemi** does not convey any license under any of its intellectual property rights nor the rights of others. **onsemi** products are not designed, intended, or authorized for use as a critical component in life support systems or any FDA Class 3 medical devices or medical devices with a same or similar classification in a foreign jurisdiction or any devices intended for implantation in the human body. Should Buyer purchase or use **onsemi** products for any such unintended or unauthorized application, Buyer shall indemnify and hold **onsemi** and its officers, employees, subsidiaries, affiliates, and distributors harmless against all claims, costs, damages, and expenses, and reasonable attorney fees arising out of, directly or indirectly, any claim of personal injury or death associated with such unintended or unauthorized use, even if such claim alleges that **onsemi** was negligent regarding the design or manufacture of the part. **onsemi** is an Equal Opportunity/Affirmative Action Employer. This literature is subject to all applicable copyright laws and is not for resale in any manner.

ADDITIONAL INFORMATION

TECHNICAL PUBLICATIONS:

Technical Library: www.onsemi.com/design/resources/technical-documentation
onsemi Website: www.onsemi.com

ONLINE SUPPORT: www.onsemi.com/support

For additional information, please contact your local Sales Representative at www.onsemi.com/support/sales