



BeStar Technologies Inc.

Address: 761 N. 17th Street Unit 4, St. Charles, IL 60174

Tel : 847-261-2850 E-mail : sales@bestartech.com Web : www.bestartech.com

Document Number : 1709-91
Revision : A2
Total Pages : 6
Prepare by : Loki, Lo
Date : 18 December, 2017

SENER Brand Power Product

www.jlsener.com

Document Type : Specification
Product Type : Lithium/Manganese Dioxide (LiMnO₂) Coin Cell
Ordering Code : SCR2032VC02S/1225
Cell Part Number : CR2032
Cell UL Number : MH20926

A1 - New issue created by Loki, Lo on 4 Sept., 2017		
A2 - Updated section 4 by Loki, Lo on 18 Dec., 2017		

This material is the property of BeStar Technologies Inc.
Unauthorized copying or use of this material is prohibited.

1. Purpose and Scope

This document contains both general requirements, qualification requirements, and those specific electrical, mechanical requirements for this part.

2. Description

Ø20mm Lithium/Manganese Dioxide (LiMnO₂) coin cell high drain version with nominal capacity 235mAh and tabs, RoHS compliant.

3. Application

Computers and Peripherals, Portable Equipment, DECT phone, etc.

4. Component Requirement

4.1. General Requirement

4.1.1.	Operating Temperature Range	: -20°C to +70°C
4.1.2.	Storage Temperature Range	: 0°C to +30°C
4.1.3.	Storage Humidity	: 40 ~ 75%
4.1.4.	Weight	: Approx. 3.2g
4.1.5.	Materials of Positive Terminal	: SUS430
4.1.6.	Materials of Negative Terminal	: SUS430

4.2. Electrical Requirement

4.2.1.	Nominal Voltage	: 3V
4.2.2.	Nominal Capacity (under Load 15kΩ Load and 2.0V End-voltage)	: 235mAh
4.2.3.	Load Resistance	: 15KΩ
4.2.4.	Standard Discharge Current	: 0.19mA
4.2.5.	Continuous Current (Max.)	: 6mA
4.2.6.	Pulse Current (Max.)	: 20mA

4.3. Standard Characteristics

4.3.1. Discharge Characteristics

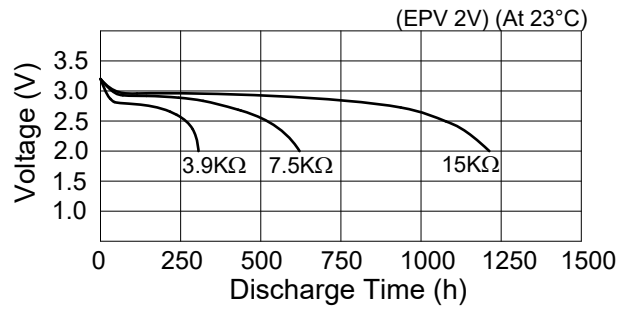

Figure 1. Discharge Characteristics

4.3.2. Load-Operating voltage

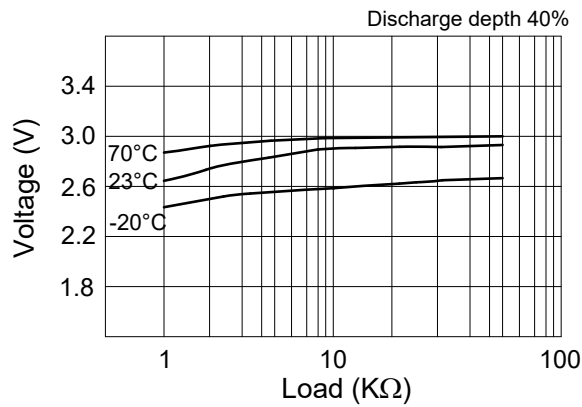

Figure 2. Load-Operating voltage

4.3.3. Pulse Discharge Characteristics

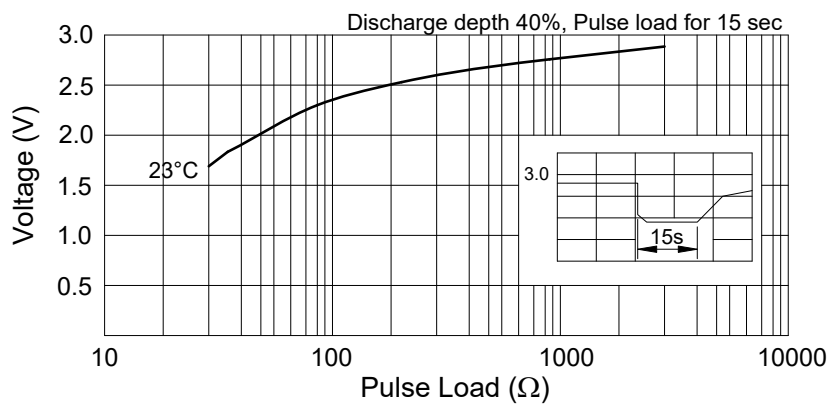

Figure 3. Pules Discharge Characteristics

4.3.4. Temperature Characteristics

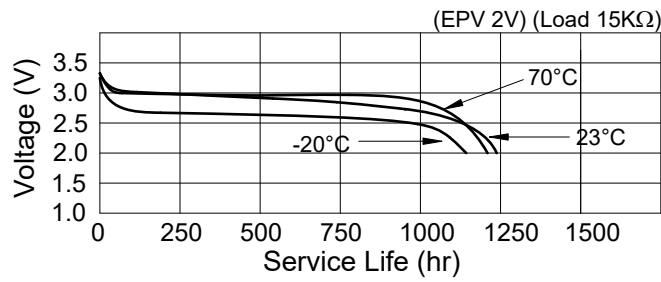

Figure 4. Temperature Characteristics

4.3.5. Load-Capacity

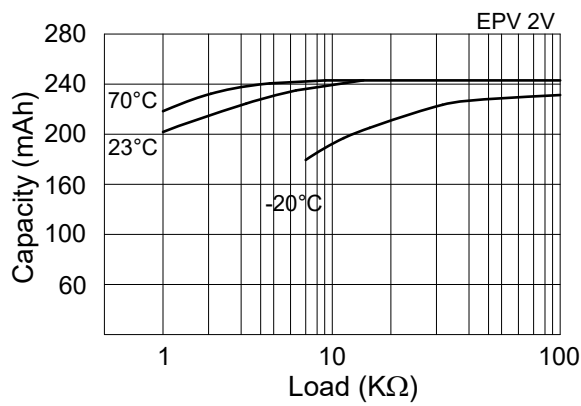

Figure 5. Load-Capacity

4.3.6. Storage Characteristics

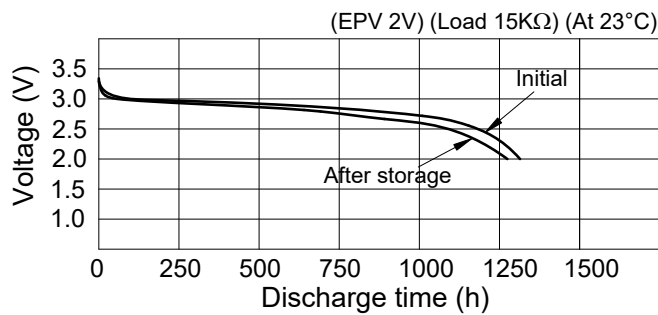

Figure 6. Storage Characteristics

5. Testing

- 5.1. Open-circuit Voltage** : Subject samples to $+20 \pm 2$ °C and 0 ± 2 °C for 8 hours or longer. Then measure the voltage between both terminals at the same ambient temperature with voltmeter.
- 5.2. Closed-circuit Voltage** : Subject samples to $+20 \pm 2$ °C and 0 ± 2 °C for 8 hours or longer. Then measure the voltage between both terminals with voltmeter while the 15k Ω is connected between both terminals at the same ambient temperature. Measured value shall be based on meter reading taken 8 seconds after the circuit is closed.
- 5.3. Service Life** : Subject samples to 20 ± 2 °C for 1200 hours or longer. Then continuously discharge at the same ambient temperature and through 15k Ω . Discharge until terminal voltage of the test specimens falls below the discharge end-point voltage of 2.0V, and the time during which the terminal voltage is equal to and above the discharge end-point voltage shall be taken as the service life.
- 5.4. Service Life after high temperature storage** : Store samples at $+60 \pm 2$ °C for 20 days. Then subject samples to $+20 \pm 2$ °C and ordinary humidity 65% \pm 20% for 12 hours or longer and continuously discharge through 15k Ω . Discharge until the voltage falls below the discharge end-point voltage of 2.0V, and the time during which the voltage is equal to and above the discharge end-point voltage shall be taken as the service life.
- 5.5. Electrolyte Leakage Test** : Samples shall be examined for electrolyte leakage while they are kept at ordinary temperature and humidity after being stored at 45 ± 2 °C and 75% relative humidity for 30 days.
- 5.6. Self-discharge** : Store samples for 12 months at $+20 \pm 2$ °C and 65% \pm 5% relative humidity and tested for service life in accordance with the method specified in 5.3. Self-discharge shall be determined as follows:

$$\text{Self-discharge rate (\%)} = (Y1-Y2)/Y1 \times 100\%P$$

Y1 : Average initial discharge life of batteries of the same lot

Y2 : Average discharge life after storage

6. Mechanical Layout

Unit : mm

Tolerance : Linear XX.X = ±0.3
 XX.XX = ±0.05
 Angular = ±0.25°

(unless otherwise specified)

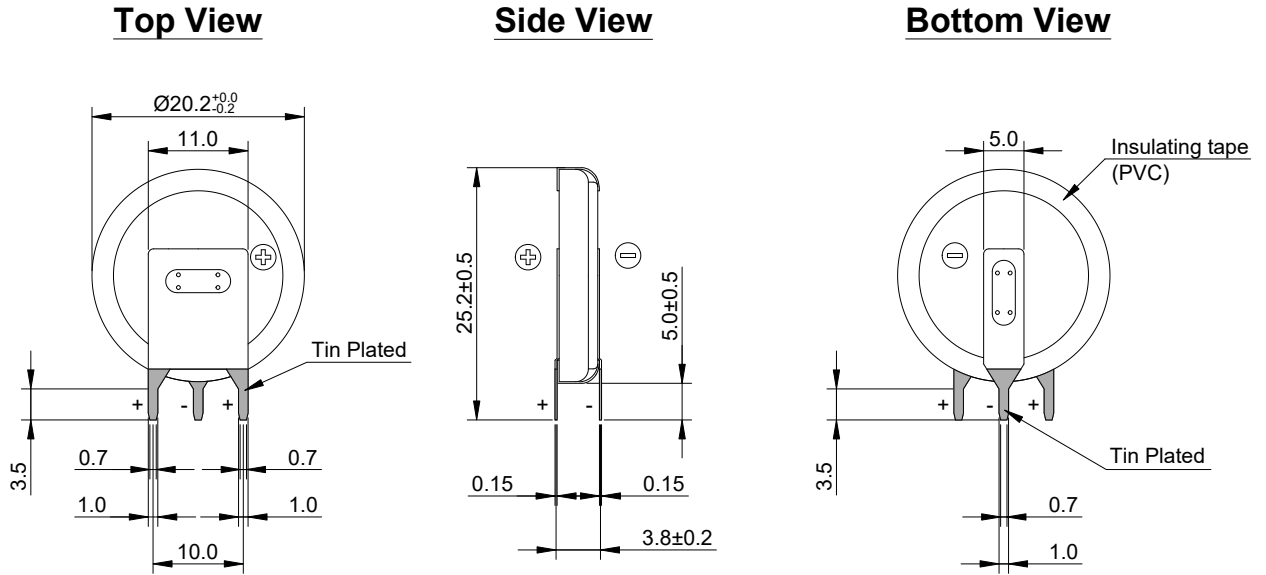

Figure 7. SCR2032VC02S/1225 Mechanical Layout