



Quartz Crystal

SMD-version

model	KX – 5T
frequency	26,0 MHz
mode	fundamental
operating temperature	-40° ~ +85°C
frequency tolerance at +25°C	± 10 ppm
temperature tolerance -40° ~ +85°C	±20 ppm
load capacitance C_L	10 pF
series resonance R1 max.	60 Ohm
aging at +25°C (first year) max.	± 2 ppm
shunt capacitance C_0 max.	3,5 pF
drive level	50 μ W typ., 100 μ W max.
contents of reel	3000 pcs.
part no.	12.85521

Dimensions (mm):

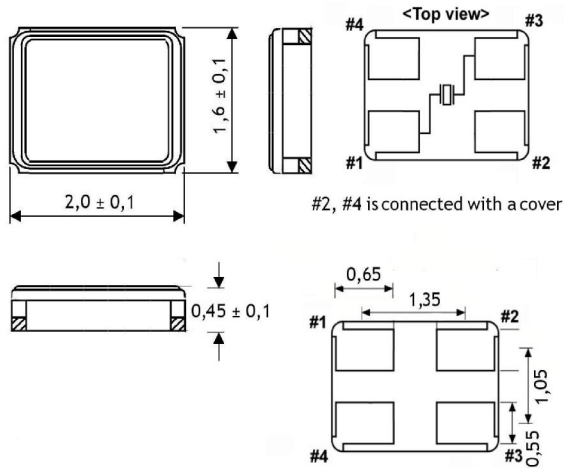

Reflow soldering condition:

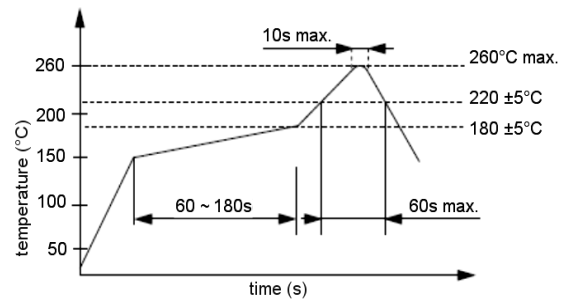

Suggested soldering pad:

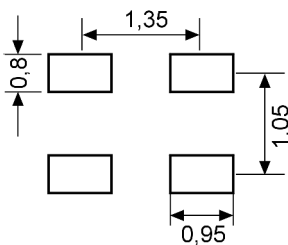

Tape specification:

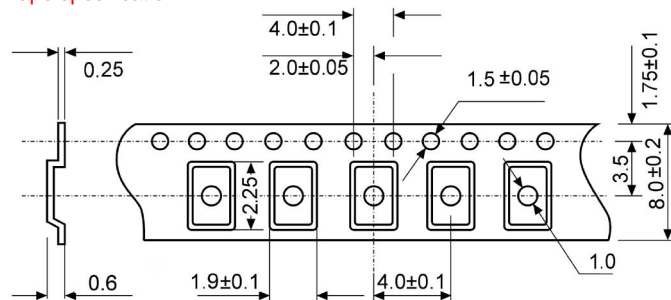

reel diameter 178 mm