

NXH160T120L2Q2F2SG

Split T-Type NPC Power Module

1200 V, 160 A IGBT, 600 V, 100 A IGBT

The NXH160T120L2Q2F2SG is a power module containing a split T-type neutral point clamped three-level inverter, consisting of two 160 A / 1200 V Half Bridge IGBTs with inverse diodes, two Neutral Point 120 A / 600 V rectifiers, two 100 A / 600 V Neutral Point IGBTs with inverse diodes, two Half Bridge 60 A / 1200 V rectifiers and a negative temperature coefficient thermistor (NTC).

Features

- Split T-type Neutral Point Clamped Three-level Inverter Module
- 1200 V IGBT Specifications: $V_{CE(SAT)} = 2.15 \text{ V}$, $E_{SW} = 4300 \mu\text{J}$
- 600 V IGBT specifications: $V_{CE(SAT)} = 1.47 \text{ V}$, $E_{SW} = 2560 \mu\text{J}$
- Baseplate
- Solderable Pins
- Thermistor

Typical Applications

- Solar Inverters
- Uninterruptible Power Supplies

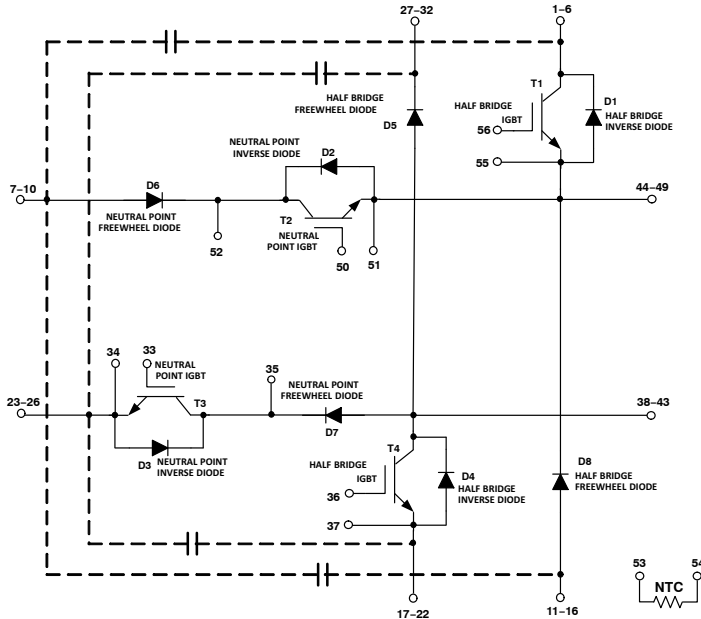
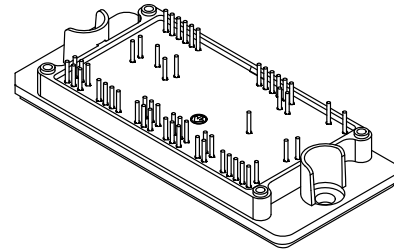

Figure 1. NXH160T120L2Q2F2SG Schematic Diagram



ON Semiconductor®

www.onsemi.com



Q2PACK
CASE 180AK

MARKING DIAGRAM

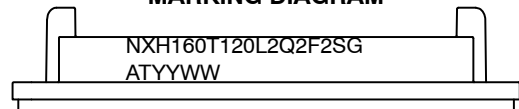

NXH160T120L2Q2F2SG = Device Code
YYWW = Year and Work Week Code
A = Assembly Site Code
T = Test Site Code
G = Pb-Free Package

PIN CONNECTIONS

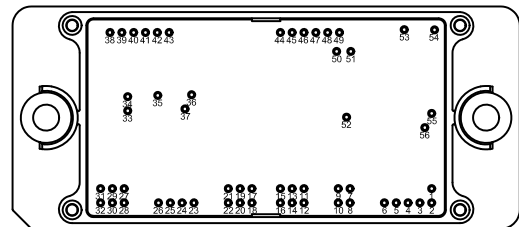

ORDERING INFORMATION

See detailed ordering and shipping information on page 5 of this data sheet.

NXH160T120L2Q2F2SG

Table 1. ABSOLUTE MAXIMUM RATINGS (Note 1) $T_J = 25^\circ\text{C}$ unless otherwise noted

Rating	Symbol	Value	Unit
HALF BRIDGE IGBT			
Collector–Emitter Voltage	V_{CES}	1200	V
Gate–Emitter Voltage	V_{GE}	± 20	V
Continuous Collector Current @ $T_h = 80^\circ\text{C}$ ($T_J = 175^\circ\text{C}$)	I_C	181	A
Pulsed Collector Current ($T_J = 175^\circ\text{C}$)	I_{Cpulse}	543	A
Maximum Power Dissipation @ $T_h = 80^\circ\text{C}$ ($T_J = 175^\circ\text{C}$)	P_{tot}	500	W
Short Circuit Withstand Time @ $V_{GE} = 15\text{ V}$, $V_{CE} = 600\text{ V}$, $T_J \leq 150^\circ\text{C}$	T_{sc}	5	μs
Minimum Operating Junction Temperature	T_{JMIN}	-40	$^\circ\text{C}$
Maximum Operating Junction Temperature	T_{JMAX}	150	$^\circ\text{C}$
NEUTRAL POINT IGBT			
Collector–Emitter Voltage	V_{CES}	600	V
Gate–Emitter Voltage	V_{GE}	± 20	V
Continuous Collector Current @ $T_h = 80^\circ\text{C}$ ($T_J = 175^\circ\text{C}$)	I_C	116	A
Pulsed Collector Current ($T_J = 175^\circ\text{C}$)	I_{Cpulse}	348	A
Maximum Power Dissipation @ $T_h = 80^\circ\text{C}$ ($T_J = 175^\circ\text{C}$)	P_{tot}	232	W
Short Circuit Withstand Time @ $V_{GE} = 15\text{ V}$, $V_{CE} = 400\text{ V}$, $T_J \leq 150^\circ\text{C}$	T_{sc}	5	μs
Minimum Operating Junction Temperature	T_{JMIN}	-40	$^\circ\text{C}$
Maximum Operating Junction Temperature	T_{JMAX}	150	$^\circ\text{C}$
HALF BRIDGE FREEWHEEL DIODE			
Peak Repetitive Reverse Voltage	V_{RRM}	1200	V
Continuous Forward Current @ $T_h = 80^\circ\text{C}$ ($T_J = 175^\circ\text{C}$)	I_F	56	A
Repetitive Peak Forward Current ($T_J = 175^\circ\text{C}$, t_p limited by T_{Jmax})	I_{FRM}	150	A
Maximum Power Dissipation @ $T_h = 80^\circ\text{C}$ ($T_J = 175^\circ\text{C}$)	P_{tot}	142	W
Minimum Operating Junction Temperature	T_{JMIN}	-40	$^\circ\text{C}$
Maximum Operating Junction Temperature	T_{JMAX}	150	$^\circ\text{C}$
HALF BRIDGE INVERSE DIODE			
Peak Repetitive Reverse Voltage	V_{RRM}	1200	V
Continuous Forward Current @ $T_h = 80^\circ\text{C}$ ($T_J = 175^\circ\text{C}$)	I_F	19	A
Repetitive Peak Forward Current ($T_J = 175^\circ\text{C}$, t_p limited by T_{Jmax})	I_{FRM}	50	A
Maximum Power Dissipation @ $T_h = 80^\circ\text{C}$ ($T_J = 175^\circ\text{C}$)	P_{tot}	63	W
Minimum Operating Junction Temperature	T_{JMIN}	-40	$^\circ\text{C}$
Maximum Operating Junction Temperature	T_{JMAX}	150	$^\circ\text{C}$
NEUTRAL POINT FREEWHEEL DIODE			
Peak Repetitive Reverse Voltage	V_{RRM}	600	V
Continuous Forward Current @ $T_h = 80^\circ\text{C}$ ($T_J = 175^\circ\text{C}$)	I_F	132	A
Repetitive Peak Forward Current ($T_J = 175^\circ\text{C}$, t_p limited by T_{Jmax})	I_{FRM}	300	A
Maximum Power Dissipation @ $T_h = 80^\circ\text{C}$ ($T_J = 175^\circ\text{C}$)	P_{tot}	198	W
Minimum Operating Junction Temperature	T_{JMIN}	-40	$^\circ\text{C}$
Maximum Operating Junction Temperature	T_{JMAX}	150	$^\circ\text{C}$
NEUTRAL POINT INVERSE DIODE			
Peak Repetitive Reverse Voltage	V_{RRM}	600	V
Continuous Forward Current @ $T_h = 80^\circ\text{C}$ ($T_J = 175^\circ\text{C}$)	I_F	38	A
Repetitive Peak Forward Current ($T_J = 175^\circ\text{C}$, t_p limited by T_{Jmax})	I_{FRM}	110	A
Maximum Power Dissipation @ $T_h = 80^\circ\text{C}$ ($T_J = 175^\circ\text{C}$)	P_{tot}	79	W
Minimum Operating Junction Temperature	T_{JMIN}	-40	$^\circ\text{C}$

NXH160T120L2Q2F2SG

Table 1. ABSOLUTE MAXIMUM RATINGS (Note 1) $T_J = 25^\circ\text{C}$ unless otherwise noted

Rating	Symbol	Value	Unit
NEUTRAL POINT INVERSE DIODE			
Maximum Operating Junction Temperature	T_{JMAX}	150	$^\circ\text{C}$
THERMAL PROPERTIES			
Storage Temperature range	T_{stg}	-40 to 125	$^\circ\text{C}$
INSULATION PROPERTIES			
Isolation test voltage, $t = 1$ sec, 60Hz	V_{is}	3000	V_{RMS}
Creepage distance		12.7	mm

Stresses exceeding those listed in the Maximum Ratings table may damage the device. If any of these limits are exceeded, device functionality should not be assumed, damage may occur and reliability may be affected.

1. Refer to ELECTRICAL CHARACTERISTICS, RECOMMENDED OPERATING RANGES and/or APPLICATION INFORMATION for Safe Operating parameters.

Table 2. RECOMMENDED OPERATING RANGES

Rating	Symbol	Min	Max	Unit
Module Operating Junction Temperature	T_J	-40	$(T_{jmax} - 25)$	$^\circ\text{C}$

Functional operation above the stresses listed in the Recommended Operating Ranges is not implied. Extended exposure to stresses beyond the Recommended Operating Ranges limits may affect device reliability.

Table 3. ELECTRICAL CHARACTERISTICS $T_J = 25^\circ\text{C}$ unless otherwise noted

Parameter	Test Conditions	Symbol	Min	Typ	Max	Unit	
HALF BRIDGE IGBT CHARACTERISTICS							
Collector-Emitter Cutoff Current	$V_{GE} = 0\text{ V}, V_{CE} = 1200\text{ V}$	I_{CES}	-	-	500	μA	
Collector-Emitter Saturation Voltage	$V_{GE} = 15\text{ V}, I_C = 160\text{ A}, T_J = 25^\circ\text{C}$	$V_{CE(sat)}$	-	2.15	2.7	V	
	$V_{GE} = 15\text{ V}, I_C = 160\text{ A}, T_J = 150^\circ\text{C}$		-	2.08	-		
Gate-Emitter Threshold Voltage	$V_{GE} = V_{CE}, I_C = 6\text{ mA}$	$V_{GE(TH)}$	-	5.53	6.4	V	
Gate Leakage Current	$V_{GE} = 20\text{ V}, V_{CE} = 0\text{ V}$	I_{GES}	-	-	500	nA	
Turn-on Delay Time	$T_J = 25^\circ\text{C}$ $V_{CE} = 350\text{ V}, I_C = 100\text{ A}$ $V_{GE} = \pm 15\text{ V}, R_G = 4\ \Omega$	$t_{d(on)}$	-	105	-	ns	
Rise Time		t_r	-	50	-		
Turn-off Delay Time		$t_{d(off)}$	-	270	-		
Fall Time		t_f	-	55	-		
Turn-on Switching Loss per Pulse		E_{on}	-	1700	-		μJ
Turn off Switching Loss per Pulse		E_{off}	-	2600	-		
Turn-on Delay Time	$T_J = 125^\circ\text{C}$ $V_{CE} = 350\text{ V}, I_C = 100\text{ A}$ $V_{GE} = \pm 15\text{ V}, R_G = 4\ \Omega$	$t_{d(on)}$	-	95	-	ns	
Rise Time		t_r	-	55	-		
Turn-off Delay Time		$t_{d(off)}$	-	285	-		
Fall Time		t_f	-	150	-		
Turn-on Switching Loss per Pulse		E_{on}	-	2300	-		μJ
Turn off Switching Loss per Pulse		E_{off}	-	4600	-		
Input Capacitance	$V_{CE} = 25\text{ V}, V_{GE} = 0\text{ V}, f = 10\text{ kHz}$	C_{ies}	-	38800	-	pF	
Output Capacitance		C_{oes}	-	800	-		
Reverse Transfer Capacitance		C_{res}	-	680	-		
Total Gate Charge	$V_{CE} = 600\text{ V}, I_C = 160\text{ A}, V_{GE} = 15\text{ V}$	Q_g	-	1600	-	nC	
Thermal Resistance - chip-to-heatsink	Thermal grease, Thickness < 100 μm , $\lambda = 0.84\text{ W/mK}$	R_{thJH}	-	0.19	-	$^\circ\text{C/W}$	

NXH160T120L2Q2F2SG

Table 3. ELECTRICAL CHARACTERISTICS $T_J = 25^\circ\text{C}$ unless otherwise noted

Parameter	Test Conditions	Symbol	Min	Typ	Max	Unit
NEUTRAL POINT FREEWHEEL DIODE CHARACTERISTICS						
Diode Reverse Leakage Current	$V_R = 600\text{ V}$	I_R	–	–	100	μA
Diode Forward Voltage	$I_F = 120\text{ A}, T_J = 25^\circ\text{C}$	V_F	–	1.24	1.5	V
	$I_F = 120\text{ A}, T_J = 150^\circ\text{C}$		–	1.20	–	
Reverse Recovery Time	$T_J = 25^\circ\text{C}$ $V_{CE} = 350\text{ V}, I_C = 100\text{ A}$ $V_{GE} = \pm 15\text{ V}, R_G = 4\ \Omega$	t_{rr}	–	50	–	ns
Reverse Recovery Charge		Q_{rr}	–	1700	–	nC
Peak Reverse Recovery Current		I_{RRM}	–	59	–	A
Peak Rate of Fall of Recovery Current		di/dt	–	2500	–	A/ μs
Reverse Recovery Energy		E_{rr}	–	380	–	μJ
Reverse Recovery Time	$T_J = 125^\circ\text{C}$ $V_{CE} = 350\text{ V}, I_C = 100\text{ A}$ $V_{GE} = \pm 15\text{ V}, R_G = 4\ \Omega$	t_{rr}	–	77	–	ns
Reverse Recovery Charge		Q_{rr}	–	3600	–	nC
Peak Reverse Recovery Current		I_{RRM}	–	77	–	A
Peak Rate of Fall of Recovery Current		di/dt	–	1900	–	A/ μs
Reverse Recovery Energy		E_{rr}	–	780	–	μJ
Thermal Resistance – chip-to-heatsink	Thermal grease, Thickness < 100 μm , $\lambda = 0.84\text{ W/mK}$	R_{thJH}	–	0.48	–	$^\circ\text{C/W}$

NEUTRAL POINT IGBT CHARACTERISTICS

Collector–Emitter Cutoff Current	$V_{GE} = 0\text{ V}, V_{CE} = 600\text{ V}$	I_{CES}	–	–	300	μA
Collector–Emitter Saturation Voltage	$V_{GE} = 15\text{ V}, I_C = 100\text{ A}, T_J = 25^\circ\text{C}$	$V_{CE(sat)}$	–	1.47	1.8	V
	$V_{GE} = 15\text{ V}, I_C = 100\text{ A}, T_J = 150^\circ\text{C}$		–	1.50	–	
Gate–Emitter Threshold Voltage	$V_{GE} = V_{CE}, I_C = 1.2\text{ mA}$	$V_{GE(TH)}$	–	5.30	6.4	V
Gate Leakage Current	$V_{GE} = 20\text{ V}, V_{CE} = 0\text{ V}$	I_{GES}	–	–	300	nA
Turn–on Delay Time	$T_J = 25^\circ\text{C}$ $V_{CE} = 350\text{ V}, I_C = 100\text{ A}$ $V_{GE} = \pm 15\text{ V}, R_G = 4\ \Omega$	$t_{d(on)}$	–	50	–	ns
Rise Time		t_r	–	35	–	
Turn–off Delay Time		$t_{d(off)}$	–	135	–	
Fall Time		t_f	–	40	–	
Turn–on Switching Loss per Pulse		E_{on}	–	870	–	
Turn off Switching Loss per Pulse	E_{off}	–	1690	–		
Turn–on Delay Time	$T_J = 125^\circ\text{C}$ $V_{CE} = 350\text{ V}, I_C = 100\text{ A}$ $V_{GE} = \pm 15\text{ V}, R_G = 4\ \Omega$	$t_{d(on)}$	–	50	–	ns
Rise Time		t_r	–	37	–	
Turn–off Delay Time		$t_{d(off)}$	–	145	–	
Fall Time		t_f	–	65	–	
Turn–on Switching Loss per Pulse		E_{on}	–	1300	–	
Turn off Switching Loss per Pulse	E_{off}	–	2500	–		
Input Capacitance	$V_{CE} = 25\text{ V}, V_{GE} = 0\text{ V}, f = 10\text{ kHz}$	C_{ies}	–	18800	–	pF
Output Capacitance		C_{oes}	–	560	–	
Reverse Transfer Capacitance		C_{res}	–	500	–	
Total Gate Charge	$V_{CE} = 480\text{ V}, I_C = 80\text{ A}, V_{GE} = 15\text{ V}$	Q_g	–	790	–	nC
Thermal Resistance – chip-to-heatsink	Thermal grease, Thickness < 100 μm , $\lambda = 0.84\text{ W/mK}$	R_{thJH}	–	0.41	–	$^\circ\text{C/W}$

NXH160T120L2Q2F2SG

Table 3. ELECTRICAL CHARACTERISTICS $T_J = 25^\circ\text{C}$ unless otherwise noted

Parameter	Test Conditions	Symbol	Min	Typ	Max	Unit
HALF BRIDGE FREEWHEEL DIODE CHARACTERISTICS						
Diode Reverse Leakage Current	$V_R = 1200\text{ V}$	I_R	–	–	100	μA
Diode Forward Voltage	$I_F = 60\text{ A}, T_J = 25^\circ\text{C}$	V_F	–	2.63	3.3	V
	$I_F = 60\text{ A}, T_J = 150^\circ\text{C}$		–	2.12	–	
Reverse Recovery Time	$T_J = 25^\circ\text{C}$ $V_{CE} = 350\text{ V}, I_C = 100\text{ A}$ $V_{GE} = \pm 15\text{ V}, R_G = 4\ \Omega$	t_{rr}	–	320	–	ns
Reverse Recovery Charge		Q_{rr}	–	3700	–	nC
Peak Reverse Recovery Current		I_{RRM}	–	68	–	A
Peak Rate of Fall of Recovery Current		di/dt	–	3000	–	$\text{A}/\mu\text{s}$
Reverse Recovery Energy		E_{rr}	–	1150	–	μJ
Reverse Recovery Time		$T_J = 125^\circ\text{C}$ $V_{CE} = 350\text{ V}, I_C = 100\text{ A}$ $V_{GE} = \pm 15\text{ V}, R_G = 4\ \Omega$	t_{rr}	–	520	–
Reverse Recovery Charge	Q_{rr}		–	9000	–	nC
Peak Reverse Recovery Current	I_{RRM}		–	102	–	A
Peak Rate of Fall of Recovery Current	di/dt		–	2600	–	$\text{A}/\mu\text{s}$
Reverse Recovery Energy	E_{rr}		–	2750	–	μJ
Thermal Resistance – chip-to-heatsink	Thermal grease, Thickness < 100 μm , $\lambda = 0.84\text{ W/mK}$		R_{thJH}	–	0.67	–

HALF BRIDGE INVERSE DIODE CHARACTERISTICS

Diode Forward Voltage	$I_F = 7\text{ A}, T_J = 25^\circ\text{C}$	V_F	–	1.92	2.80	V
	$I_F = 7\text{ A}, T_J = 150^\circ\text{C}$		–	1.37	–	
Thermal Resistance – chip-to-heatsink	Thermal grease, Thickness < 100 μm , $\lambda = 0.84\text{ W/mK}$	R_{thJH}	–	1.52	–	$^\circ\text{C}/\text{W}$

NEUTRAL POINT INVERSE DIODE CHARACTERISTICS

Diode Forward Voltage	$I_F = 30\text{ A}, T_J = 25^\circ\text{C}$	V_F	–	2.24	2.75	V
	$I_F = 30\text{ A}, T_J = 150^\circ\text{C}$		–	1.60	–	
Thermal Resistance – chip-to-heatsink	Thermal grease, Thickness 100 μm , $\lambda = 0.84\text{ W/mK}$	R_{thJH}	–	1.21	–	$^\circ\text{C}/\text{W}$

THERMISTOR CHARACTERISTICS

Nominal resistance		R_{25}	–	22	–	$\text{k}\Omega$
Nominal resistance	$T = 100^\circ\text{C}$	R_{100}	–	1486	–	Ω
Deviation of R_{25}		$\Delta R/R$	–5	–	5	%
Power dissipation		P_D	–	200	–	mW
Power dissipation constant			–	2	–	mW/K
B-value	$B(25/50)$, tolerance $\pm 3\%$		–	3950	–	K
B-value	$B(25/100)$, tolerance $\pm 3\%$		–	3998	–	K

ORDERING INFORMATION

Device	Marking	Package	Shipping
NXH160T120L2Q2F2SG Q2PACK	NXH160T120L2Q2F2SG	Q2PACK – Case 180AK (Pb-Free and Halide-Free)	12 Units / Blister Tray

NXH160T120L2Q2F2SG

TYPICAL CHARACTERISTICS – Half Bridge IGBT and Neutral Point Diode

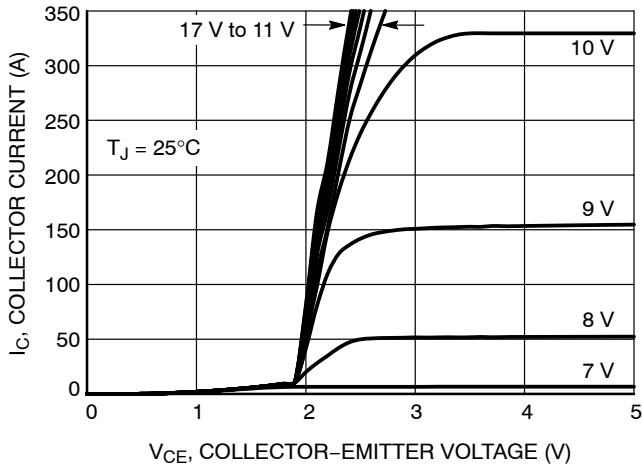

Figure 1. IGBT Typical Output Characteristics

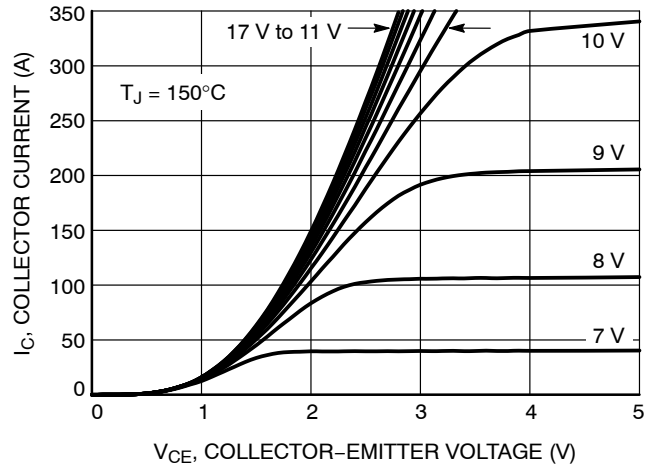

Figure 2. IGBT Typical Output Characteristics

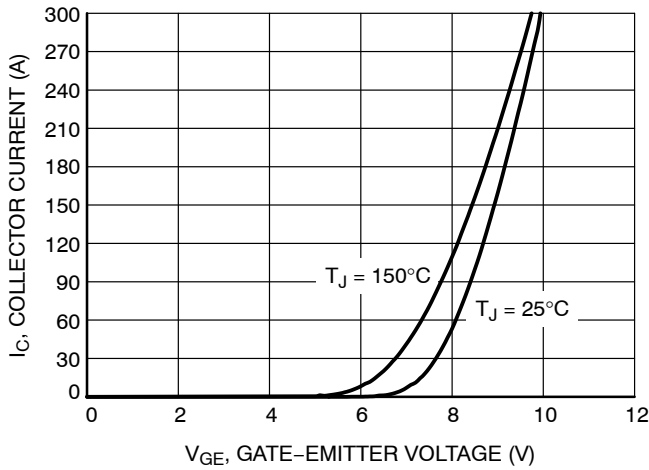

Figure 3. IGBT Typical Transfer Characteristics

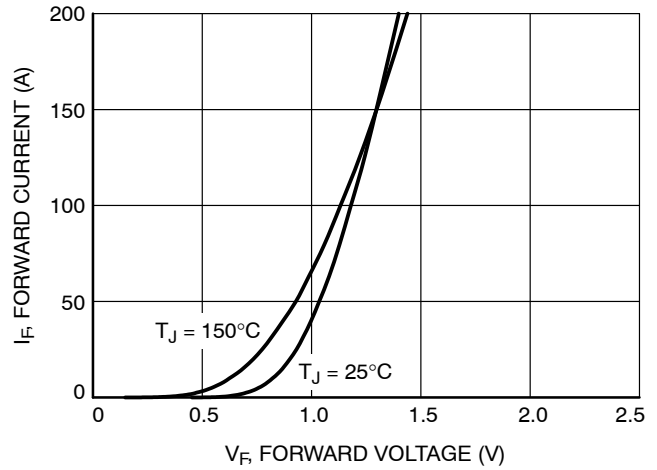

Figure 4. Diode Forward Characteristic

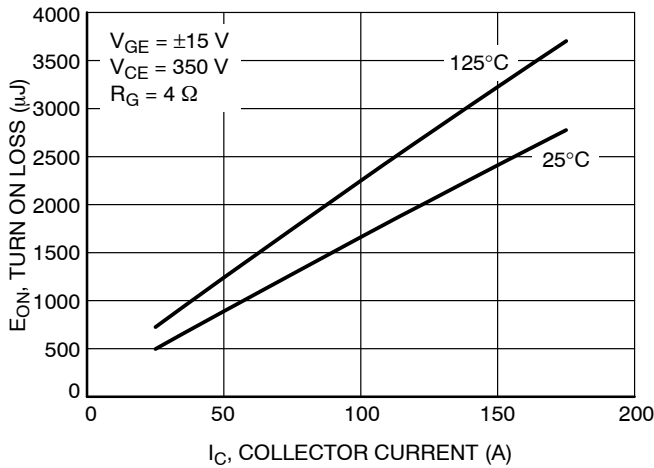

Figure 5. Typical Turn On Loss vs. IC

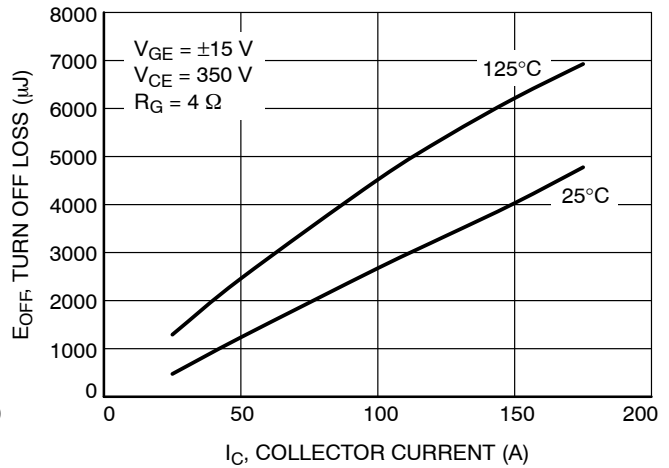

Figure 6. Typical Turn Off Loss vs. IC

NXH160T120L2Q2F2SG

TYPICAL CHARACTERISTICS – Half Bridge IGBT and Neutral Point Diode

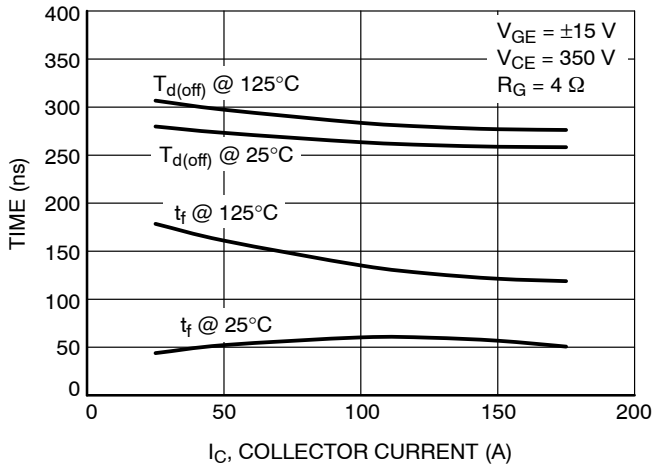

Figure 7. Typical Turn Off Time vs. I_C

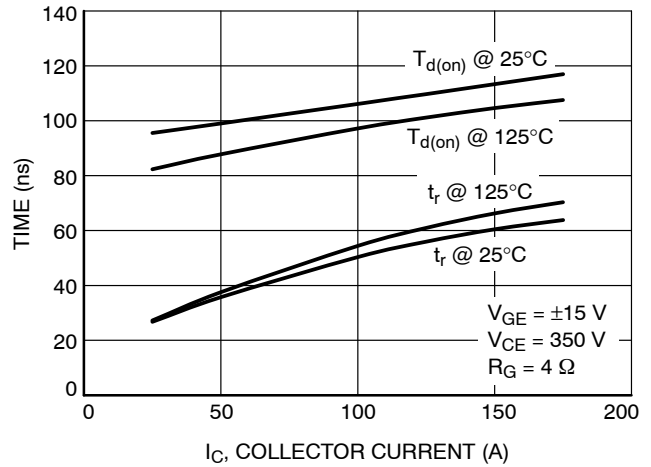

Figure 8. Typical Turn On Time vs. I_C

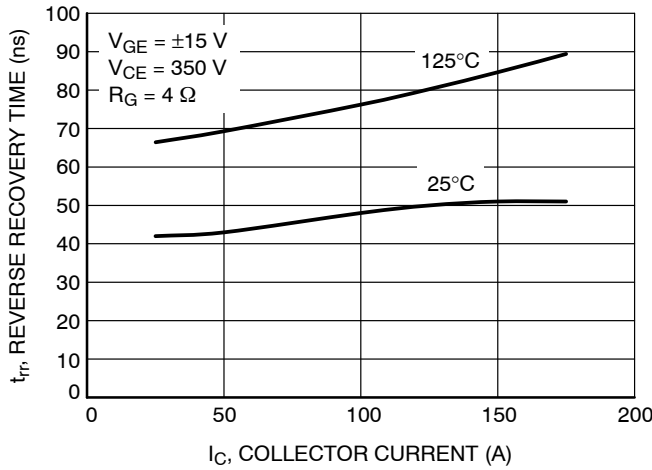

Figure 9. Typical Reverse Recovery Time vs. I_C

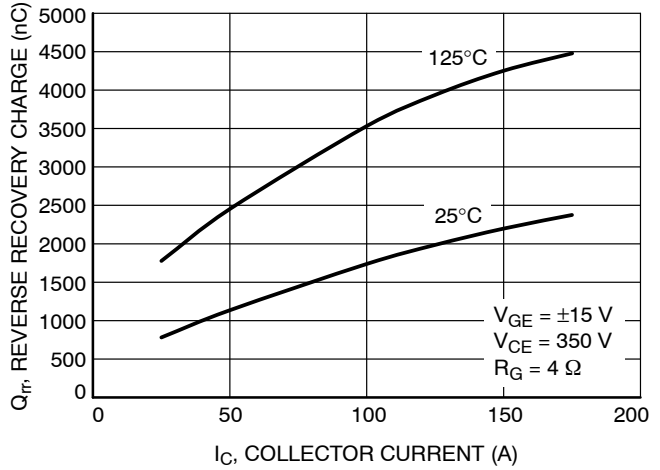

Figure 10. Typical Reverse Recovery Charge vs. I_C

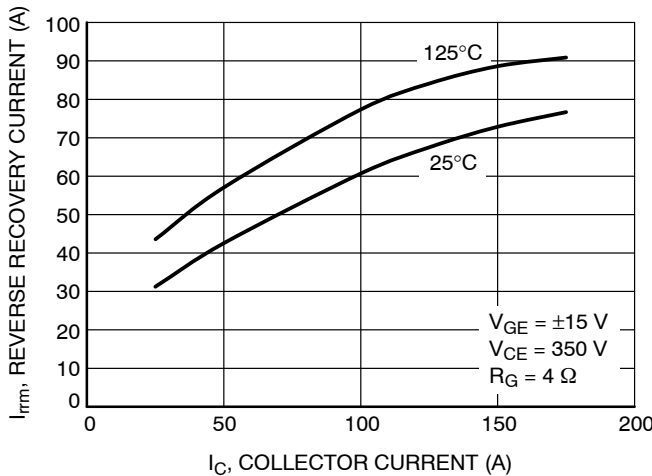

Figure 11. Typical Reverse Recovery Peak Current vs. I_C

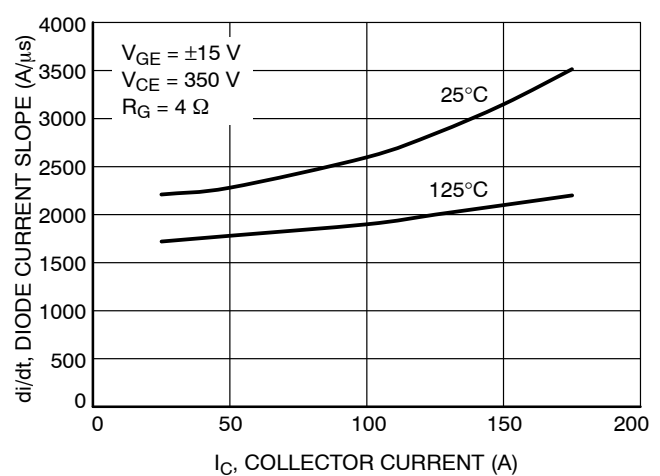

Figure 12. Typical Diode Current Slope vs. I_C

NXH160T120L2Q2F2SG

TYPICAL CHARACTERISTICS – Half Bridge IGBT and Neutral Point Diode

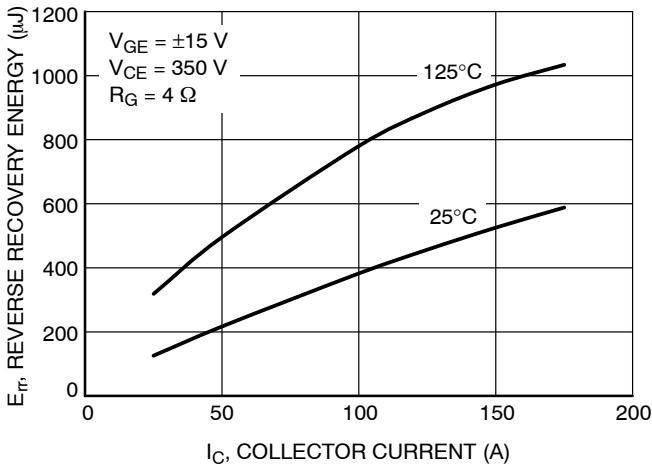

Figure 13. Typical Reverse Recovery Energy vs. I_C

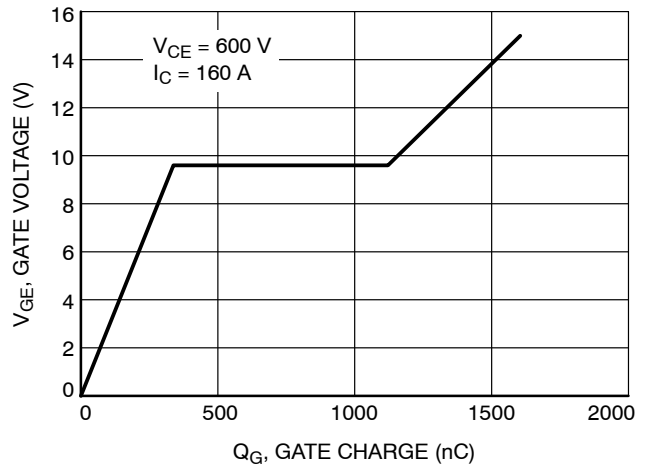

Figure 14. Gate Voltage vs. Gate Charge

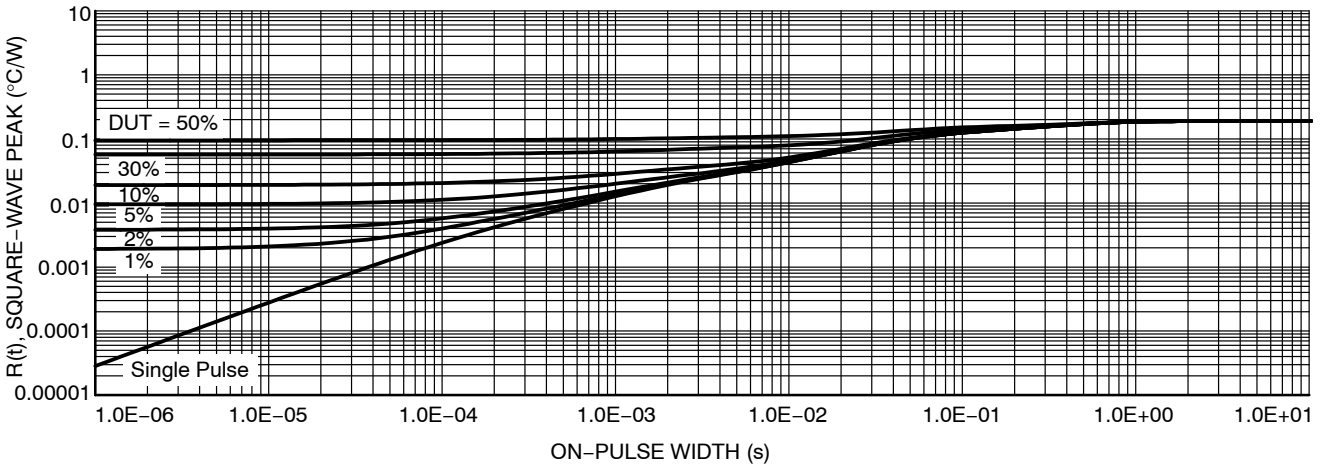

Figure 15. IGBT Transient Thermal Impedance

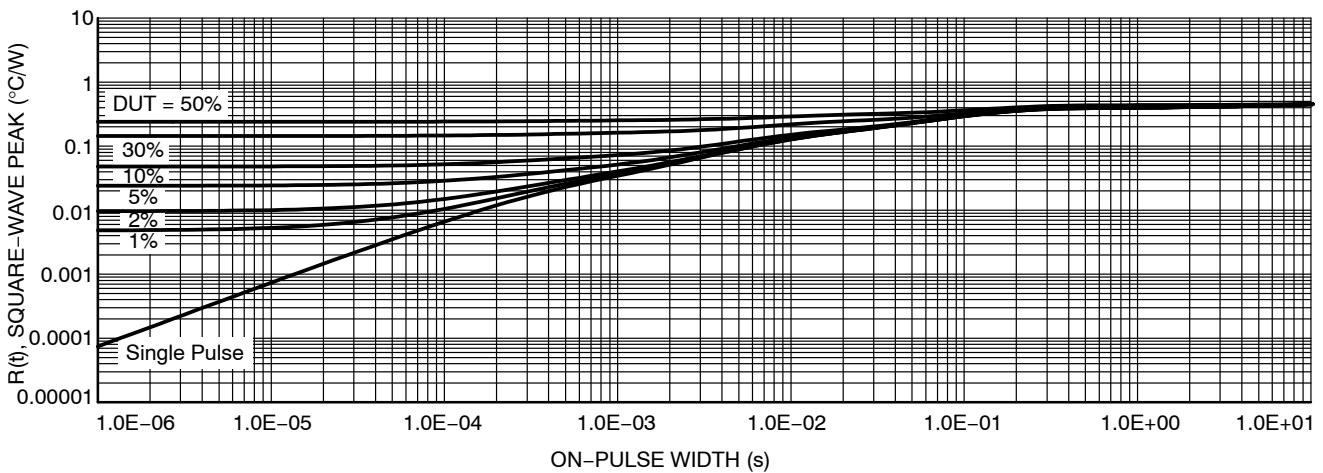

Figure 16. Diode Transient Thermal Impedance

NXH160T120L2Q2F2SG

TYPICAL CHARACTERISTICS – Neutral Point IGBT and Half Bridge Diode

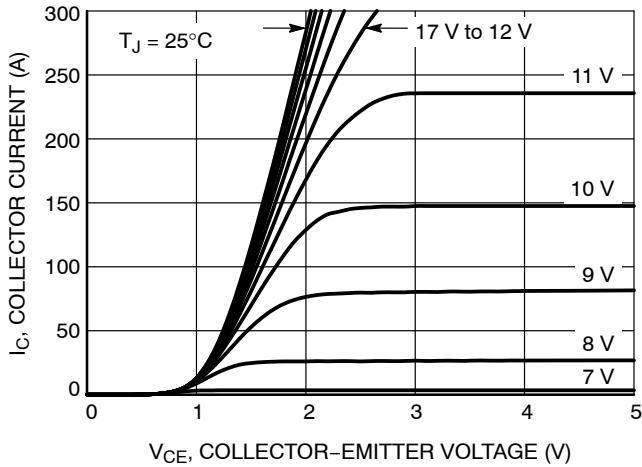

Figure 17. IGBT Typical Output Characteristics

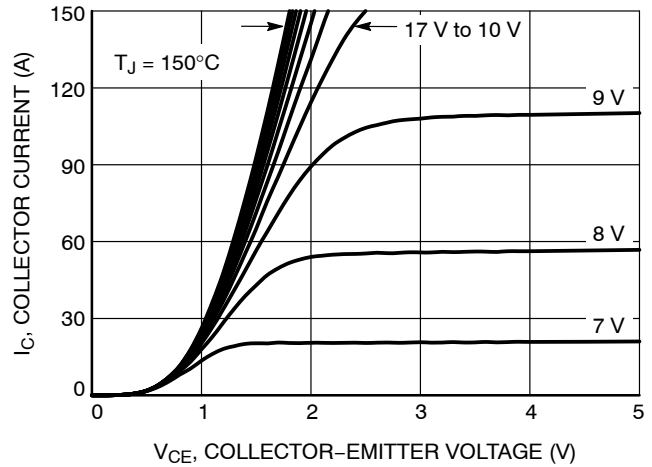

Figure 18. IGBT Typical Output Characteristics

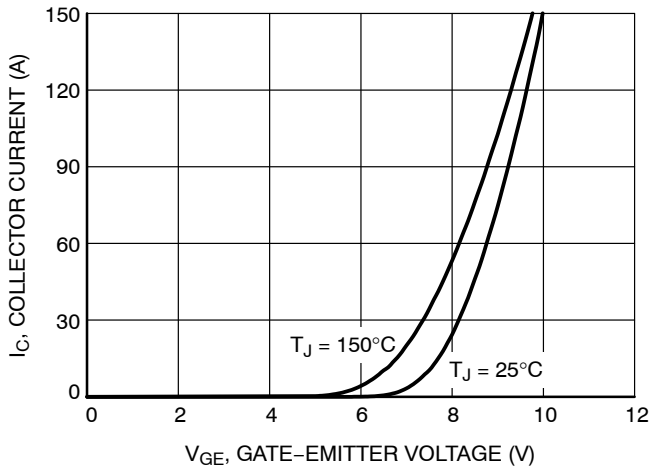

Figure 19. IGBT Typical Transfer Characteristics

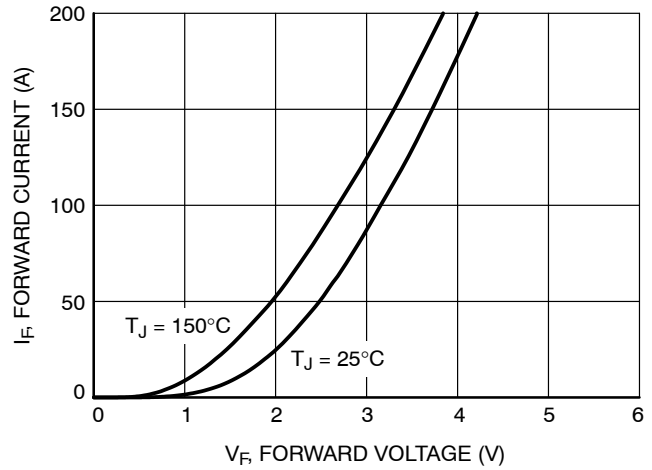

Figure 20. Diode Forward Characteristic

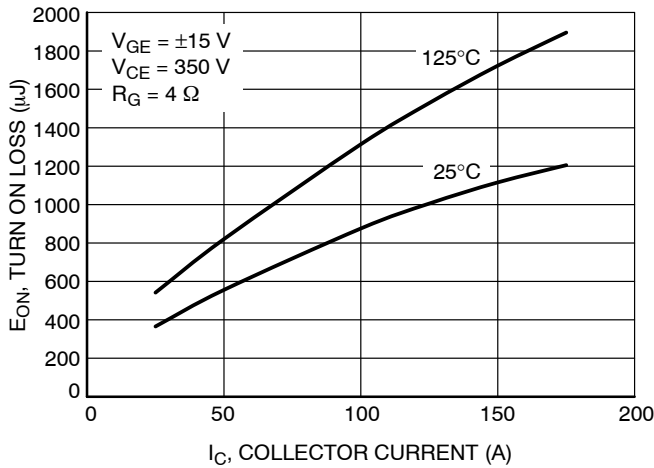

Figure 21. Typical Turn On Loss vs. IC

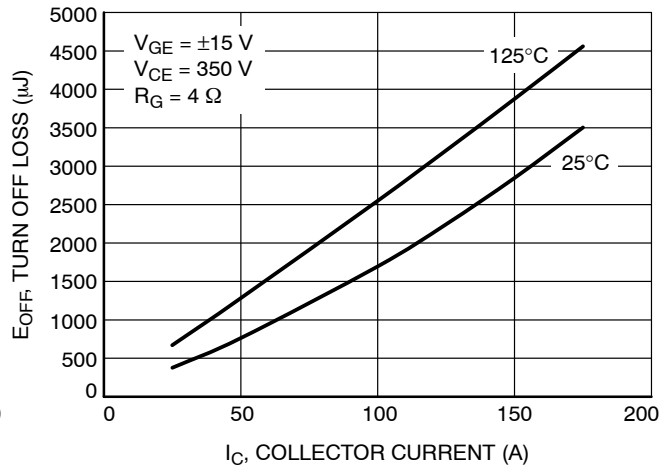

Figure 22. Typical Turn Off Loss vs. IC

NXH160T120L2Q2F2SG

TYPICAL CHARACTERISTICS – Neutral Point IGBT and Half Bridge Diode

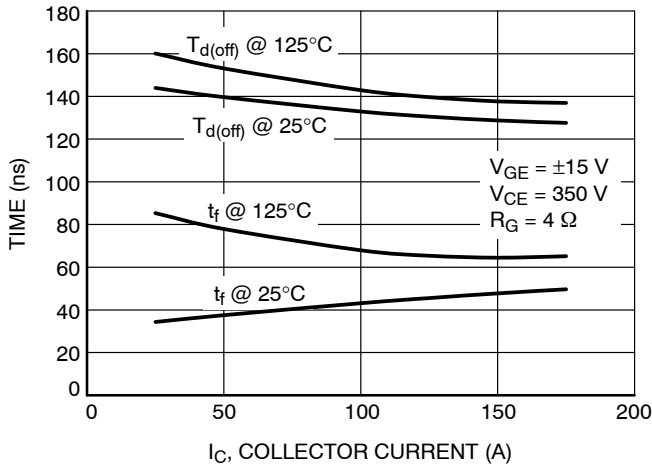

Figure 23. Typical Turn Off Time vs. IC

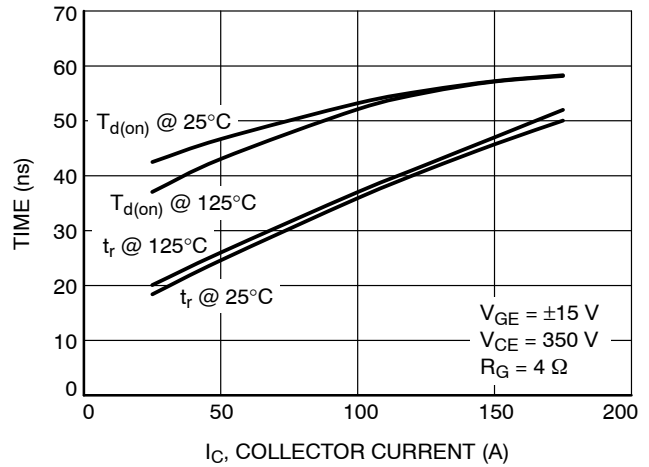

Figure 24. Typical Turn On Time vs. IC

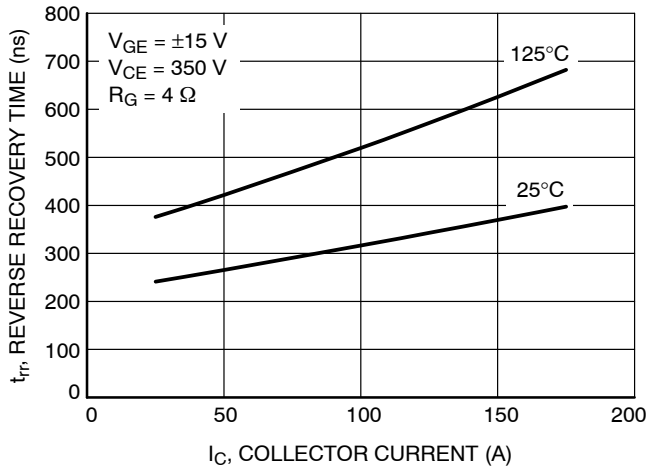

Figure 25. Typical Reverse Recovery Time vs. IC

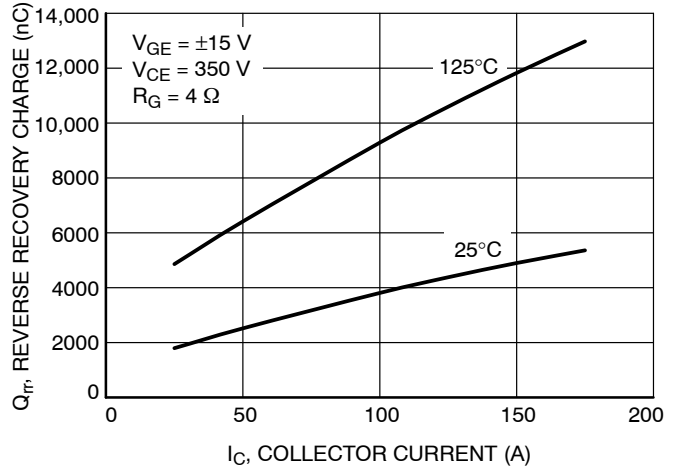

Figure 26. Typical Reverse Recovery Charge vs. IC

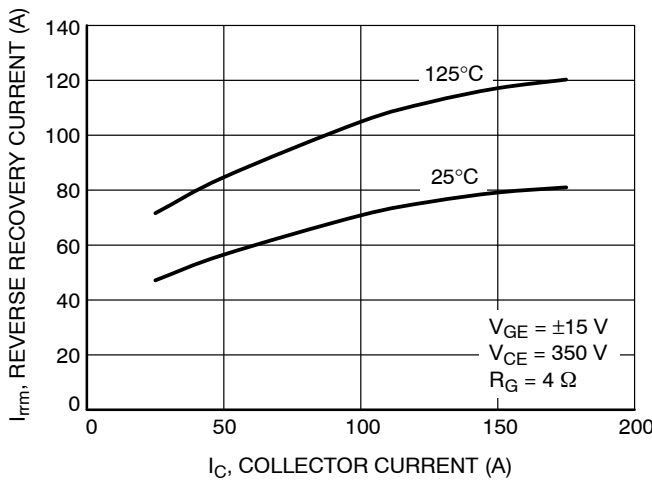

Figure 27. Typical Reverse Recovery Peak Current vs. IC

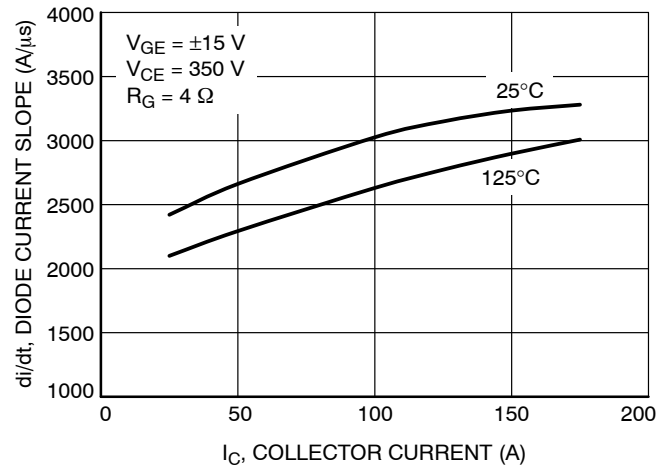

Figure 28. Typical Diode Current Slope vs. IC

NXH160T120L2Q2F2SG

TYPICAL CHARACTERISTICS – Neutral Point IGBT and Half Bridge Diode

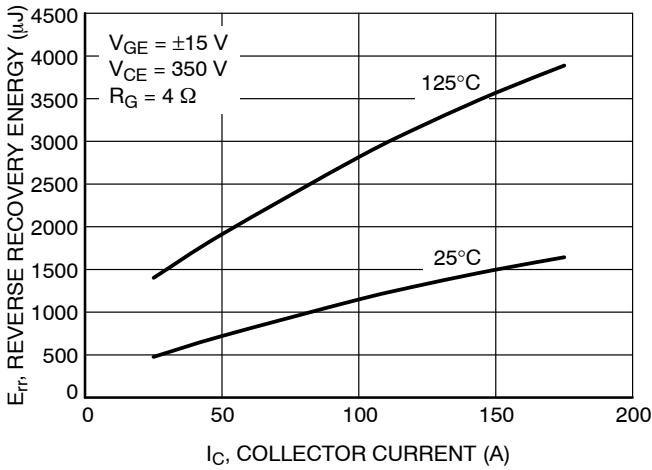

Figure 29. Typical Reverse Recovery Energy vs. I_C

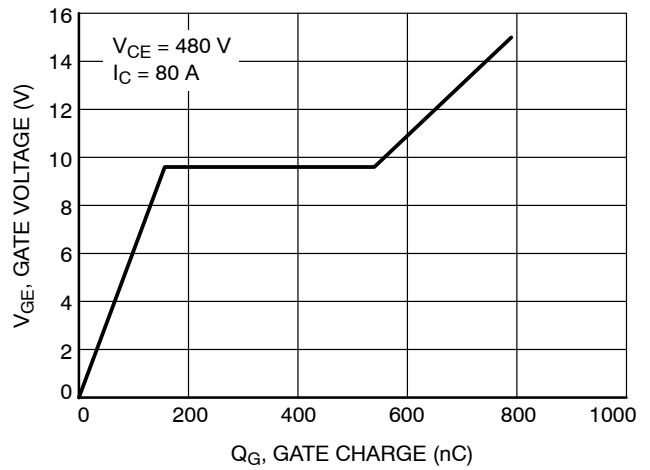

Figure 30. Gate Voltage vs. Gate Charge

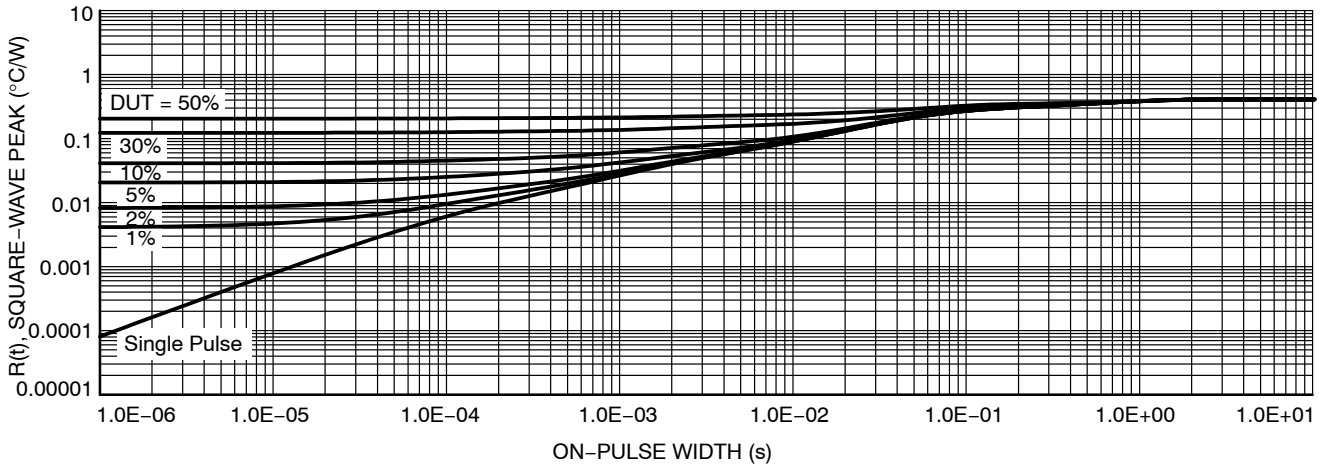

Figure 31. IGBT Transient Thermal Impedance

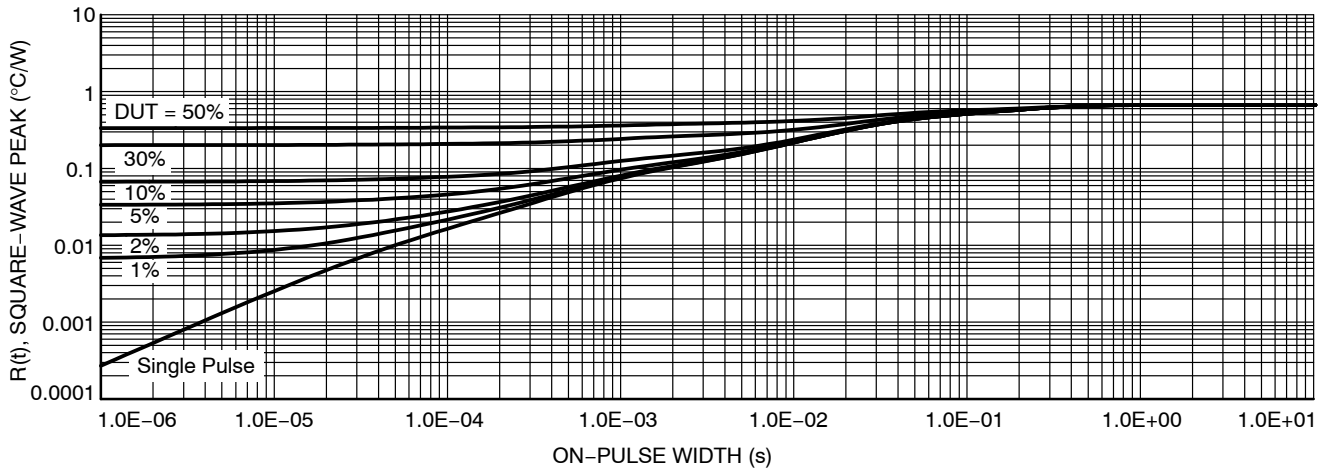

Figure 32. Diode Transient Thermal Impedance

NXH160T120L2Q2F2SG

TYPICAL CHARACTERISTICS – Half Bridge IGBT Protection Diode

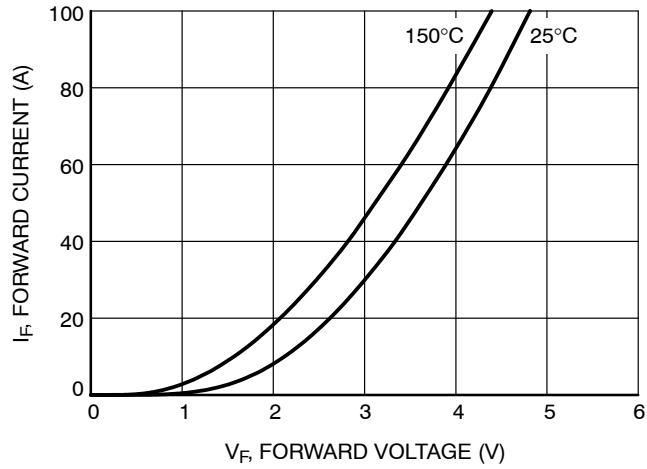

Figure 33. Diode Forward Characteristic

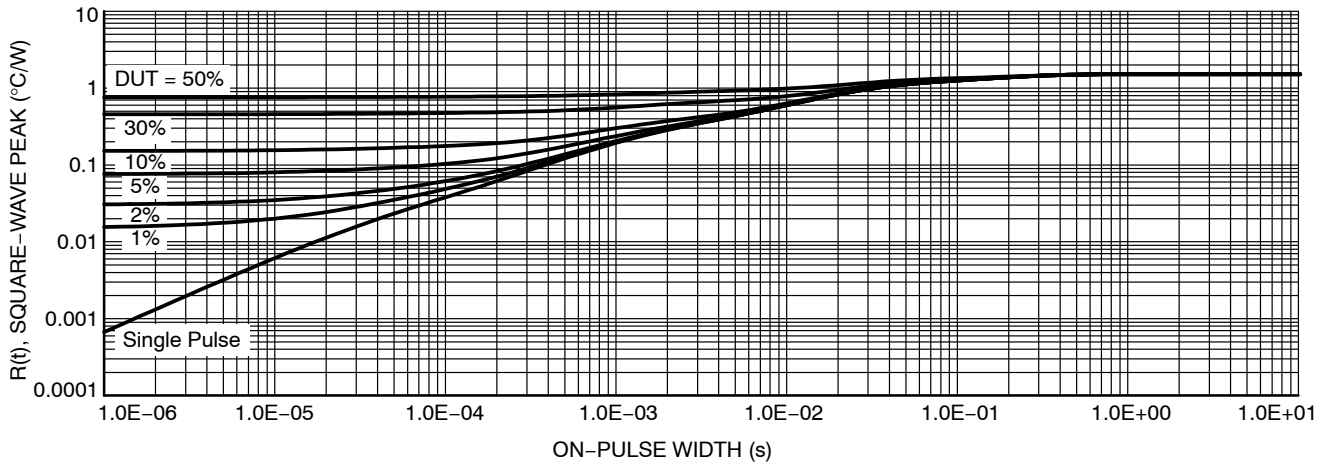

Figure 34. Diode Transient Thermal Impedance

NXH160T120L2Q2F2SG

TYPICAL CHARACTERISTICS – Neutral Point IGBT Protection Diode

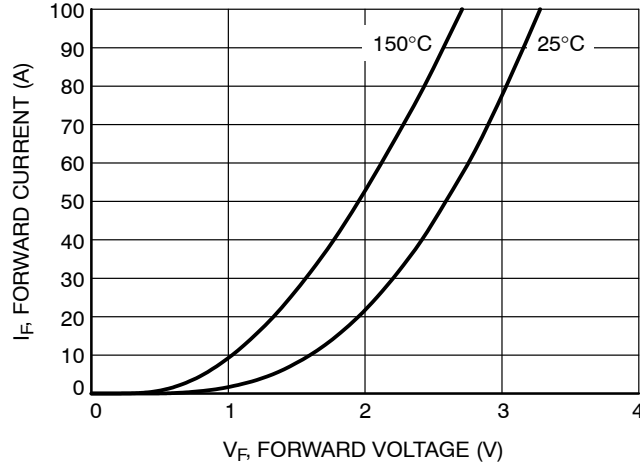

Figure 35. Diode Forward Characteristic

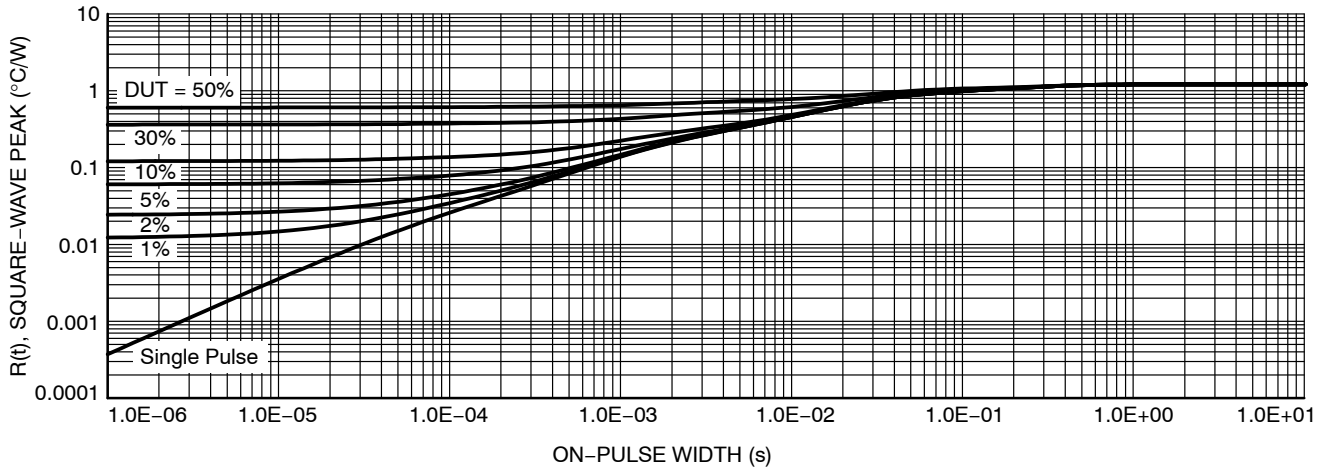

Figure 36. Diode Transient Thermal Impedance

TYPICAL CHARACTERISTICS – Thermistor

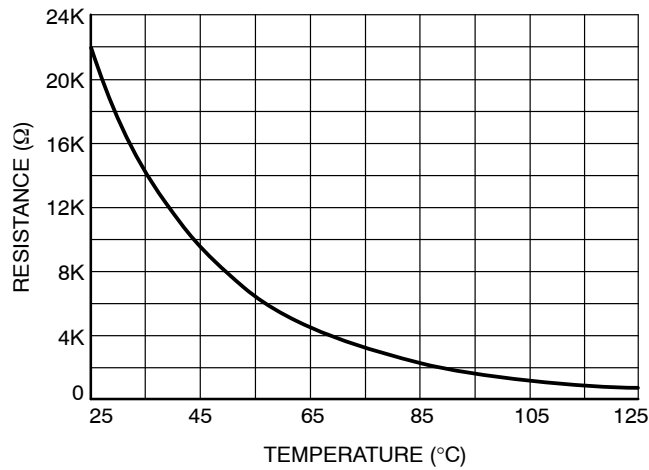

Figure 37. Thermistor Characteristics

MECHANICAL CASE OUTLINE PACKAGE DIMENSIONS

ON Semiconductor®



PIM56, 93x47 (SOLDER PIN) CASE 180AK ISSUE B

DATE 08 NOV 2017

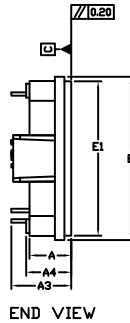
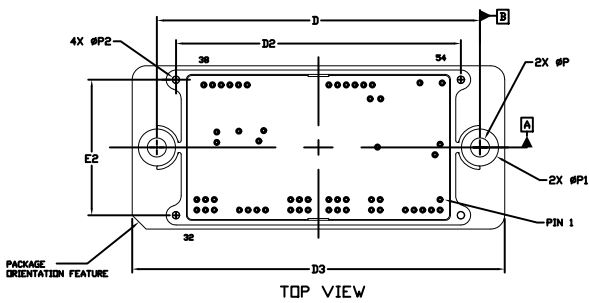
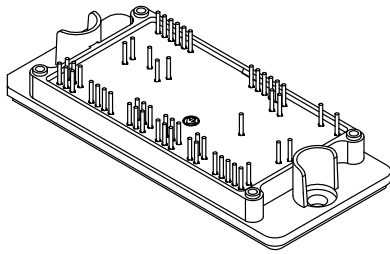

NOTES:

- DIMENSIONING AND TOLERANCING PER ASME Y14.5M, 2009.
- CONTROLLING DIMENSION= MILLIMETERS
- DIMENSIONS b APPLIES TO THE PLATED TERMINALS AND IS MEASURED BETWEEN 1.00 AND 3.00 FROM THE TERMINAL TIP.
- POSITION OF THE CENTER OF THE TERMINALS IS DETERMINED FROM DATUM B THE CENTER OF DIMENSION D, X DIRECTION, AND FROM DATUM A, Y DIRECTION. POSITIONAL TOLERANCE, AS NOTED IN DRAWING, APPLIES TO EACH TERMINAL IN BOTH DIRECTIONS.
- PACKAGE MARKING IS LOCATED AS SHOWN ON THE SIDE WITH THE PACKAGE ORIENTATION FEATURE.

MILLIMETERS		
DIM	MIN.	MAX.
A	11.80	12.20
A1	4.50	4.90
A2	16.50	16.90
A3	16.70	17.70
A4	12.80	13.20
b	0.95	1.05
D	92.80	93.20
D1	104.60	104.90
D2	81.80	82.20
D3	106.90	107.50
E	46.75	47.25
E1	44.30	44.50
E2	38.80	39.20
P	5.40	5.60
P1	10.60	10.80
P2	2.20	2.40

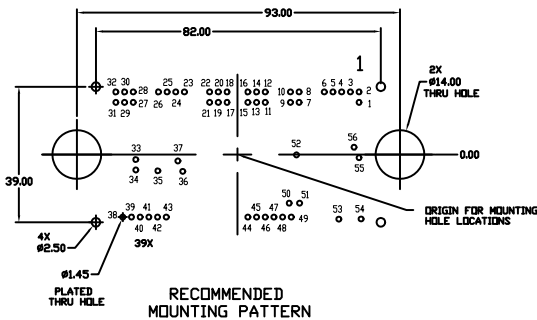
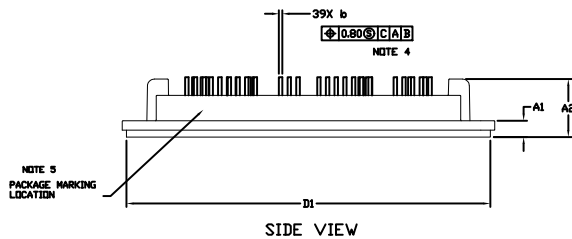

NOTE 4

PIN	PIN POSITION		PIN	PIN POSITION	
	X	Y		X	Y
1	35.00	-15.00	29	-32.50	-15.00
2	35.00	-18.00	30	-32.50	-18.00
3	32.50	-18.00	31	-35.00	-15.00
4	30.00	-18.00	32	-35.00	-18.00
5	27.50	-18.00	33	-29.25	1.45
6	25.00	-18.00	34	-29.25	4.45
7	17.75	-15.00	35	-22.90	4.70
8	17.75	-18.00	36	-15.75	4.85
9	15.25	-15.00	37	-17.15	1.85
10	15.25	-18.00	38	-33.00	18.00
11	8.00	-15.00	39	-30.50	18.00
12	8.00	-18.00	40	-28.00	18.00
13	5.50	-15.00	41	-25.50	18.00
14	5.50	-18.00	42	-23.00	18.00
15	3.00	-15.00	43	-20.50	18.00
16	3.00	-18.00	44	3.00	18.00
17	-3.00	-15.00	45	5.50	18.00
18	-3.00	-18.00	46	8.00	18.00
19	-5.50	-15.00	47	10.50	18.00
20	-5.50	-18.00	48	13.00	18.00
21	-8.00	-15.00	49	15.50	18.00
22	-8.00	-18.00	50	14.90	14.00
23	-15.25	-18.00	51	17.90	14.00
24	-17.75	-18.00	52	17.00	0.10
25	-20.25	-18.00	53	29.20	18.60
26	-22.75	-18.00	54	35.60	18.55
27	-30.00	-15.00	55	35.00	0.90
28	-30.00	-18.00	56	33.55	-2.10

MOUNTING HOLE POSITION

PIN	PIN POSITION		PIN	PIN POSITION	
	X	Y		X	Y
1	35.00	15.00	29	-32.50	15.00
2	35.00	18.00	30	-32.50	18.00
3	32.50	18.00	31	-35.00	15.00
4	30.00	18.00	32	-35.00	18.00
5	27.50	18.00	33	-29.25	-1.45
6	25.00	18.00	34	-29.25	-4.45
7	17.75	15.00	35	-22.90	-4.70
8	17.75	18.00	36	-15.75	-4.85
9	15.25	15.00	37	-17.15	-1.85
10	15.25	18.00	38	-33.00	-18.00
11	8.00	15.00	39	-30.50	-18.00
12	8.00	18.00	40	-28.00	-18.00
13	5.50	15.00	41	-25.50	-18.00
14	5.50	18.00	42	-23.00	-18.00
15	3.00	15.00	43	-20.50	-18.00
16	3.00	18.00	44	3.00	-18.00
17	-3.00	15.00	45	5.50	-18.00
18	-3.00	18.00	46	8.00	-18.00
19	-5.50	15.00	47	10.50	-18.00
20	-5.50	18.00	48	13.00	-18.00
21	-8.00	15.00	49	15.50	-18.00
22	-8.00	18.00	50	14.90	-14.00
23	-15.25	18.00	51	17.90	-14.00
24	-17.75	18.00	52	17.00	-0.10
25	-20.25	18.00	53	29.20	-18.60
26	-22.75	18.00	54	35.60	-18.55
27	-30.00	15.00	55	35.00	-0.90
28	-30.00	18.00	56	33.55	2.10

GENERIC MARKING DIAGRAM*

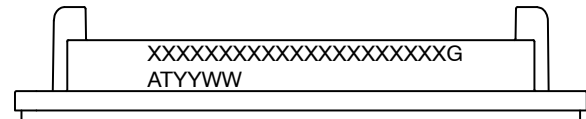

XXXXX = Specific Device Code
G = Pb-Free Package
AT = Assembly & Test Site Code
YYWW = Year and Work Week Code

*This information is generic. Please refer to device data sheet for actual part marking. Pb-Free indicator, "G" or microdot "▪", may or may not be present. Some products may not follow the Generic Marking.

DOCUMENT NUMBER:	98AON63482G	Electronic versions are uncontrolled except when accessed directly from the Document Repository. Printed versions are uncontrolled except when stamped "CONTROLLED COPY" in red.
DESCRIPTION:	PIM56 93X47 (SOLDER PIN)	PAGE 1 OF 1

ON Semiconductor and ON are trademarks of Semiconductor Components Industries, LLC dba ON Semiconductor or its subsidiaries in the United States and/or other countries. ON Semiconductor reserves the right to make changes without further notice to any products herein. ON Semiconductor makes no warranty, representation or guarantee regarding the suitability of its products for any particular purpose, nor does ON Semiconductor assume any liability arising out of the application or use of any product or circuit, and specifically disclaims any and all liability, including without limitation special, consequential or incidental damages. ON Semiconductor does not convey any license under its patent rights nor the rights of others.

onsemi, **Onsemi**, and other names, marks, and brands are registered and/or common law trademarks of Semiconductor Components Industries, LLC dba "**onsemi**" or its affiliates and/or subsidiaries in the United States and/or other countries. **onsemi** owns the rights to a number of patents, trademarks, copyrights, trade secrets, and other intellectual property. A listing of **onsemi**'s product/patent coverage may be accessed at www.onsemi.com/site/pdf/Patent-Marking.pdf. **onsemi** reserves the right to make changes at any time to any products or information herein, without notice. The information herein is provided "as-is" and **onsemi** makes no warranty, representation or guarantee regarding the accuracy of the information, product features, availability, functionality, or suitability of its products for any particular purpose, nor does **onsemi** assume any liability arising out of the application or use of any product or circuit, and specifically disclaims any and all liability, including without limitation special, consequential or incidental damages. Buyer is responsible for its products and applications using **onsemi** products, including compliance with all laws, regulations and safety requirements or standards, regardless of any support or applications information provided by **onsemi**. "Typical" parameters which may be provided in **onsemi** data sheets and/or specifications can and do vary in different applications and actual performance may vary over time. All operating parameters, including "Typicals" must be validated for each customer application by customer's technical experts. **onsemi** does not convey any license under any of its intellectual property rights nor the rights of others. **onsemi** products are not designed, intended, or authorized for use as a critical component in life support systems or any FDA Class 3 medical devices or medical devices with a same or similar classification in a foreign jurisdiction or any devices intended for implantation in the human body. Should Buyer purchase or use **onsemi** products for any such unintended or unauthorized application, Buyer shall indemnify and hold **onsemi** and its officers, employees, subsidiaries, affiliates, and distributors harmless against all claims, costs, damages, and expenses, and reasonable attorney fees arising out of, directly or indirectly, any claim of personal injury or death associated with such unintended or unauthorized use, even if such claim alleges that **onsemi** was negligent regarding the design or manufacture of the part. **onsemi** is an Equal Opportunity/Affirmative Action Employer. This literature is subject to all applicable copyright laws and is not for resale in any manner.

PUBLICATION ORDERING INFORMATION

LITERATURE FULFILLMENT:

Email Requests to: orderlit@onsemi.com

onsemi Website: www.onsemi.com

TECHNICAL SUPPORT

North American Technical Support:

Voice Mail: 1 800-282-9855 Toll Free USA/Canada

Phone: 011 421 33 790 2910

Europe, Middle East and Africa Technical Support:

Phone: 00421 33 790 2910

For additional information, please contact your local Sales Representative