

PA0106C-P-R *Proto Advantage*

Datasheet revision 1.0

www.Proto-Advantage.com

PLCC-28/JLCC-28/LCC-28 (Pin 1 Out) *Compact Series* to PGA-28 SMT Adapter (1.27 mm pitch, 12.5 x 12.5 mm body)

DIMENSIONS						
REF.	mm			inches		
	MIN.	TYP.	MAX.	MIN.	TYP.	MAX.
A		9.25				
A2		9.25				
B		2.75				
C		0.80				
D		0.47				
E		1.27				
F					0.1	
G					0.1	
H		0.46				
X					0.6	
Y					0.6	

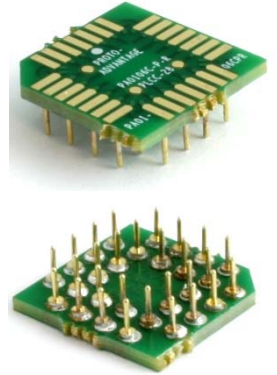

Top View (SMT Footprint)

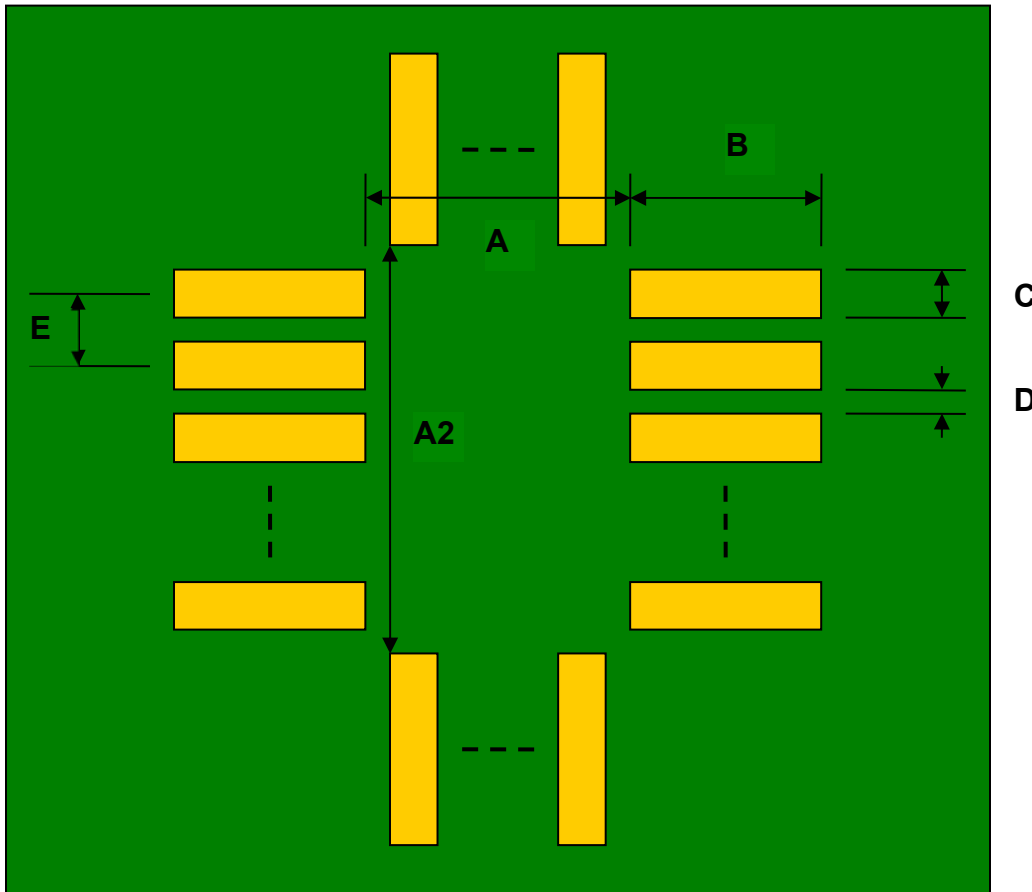

(Representative drawing only - not to scale)

Bottom View (PGA Pins)

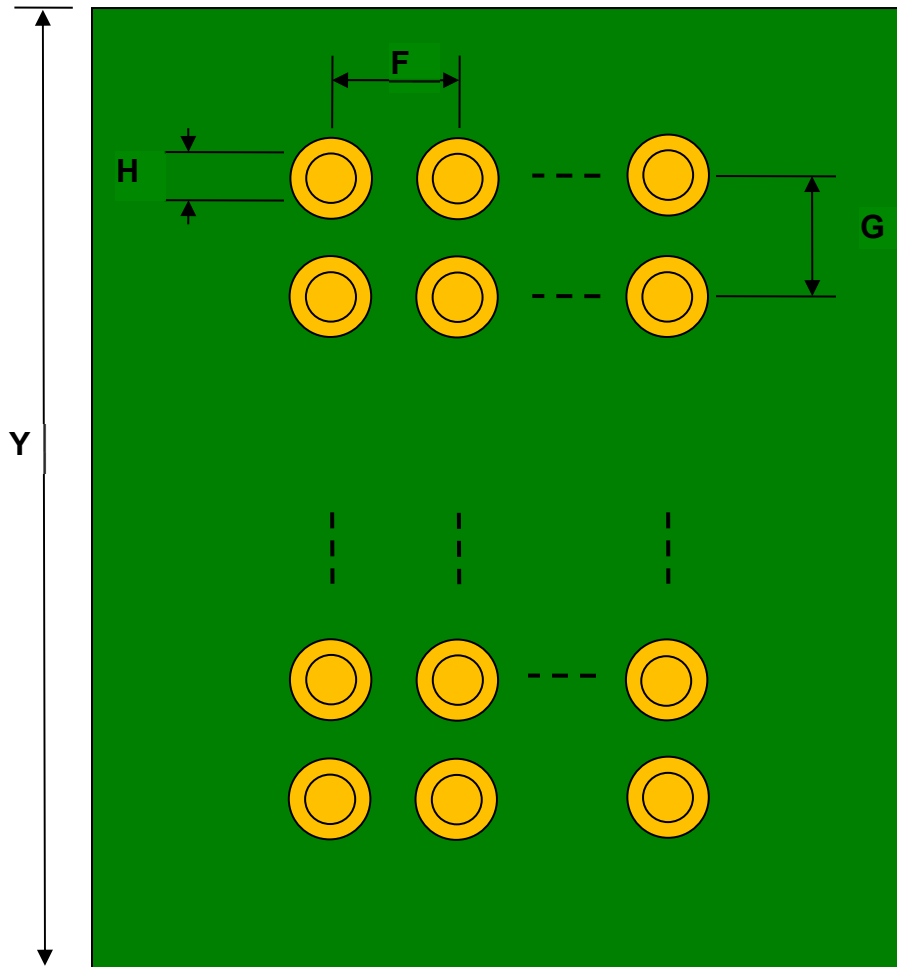

(Representative drawing only - not to scale)

Side View (PGA Pins)

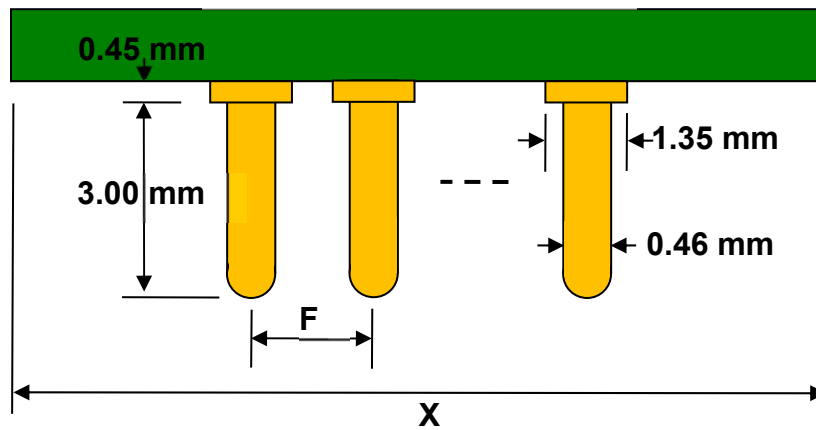

(Representative drawing only - not to scale)

Adapter Pin Out (Top Side)

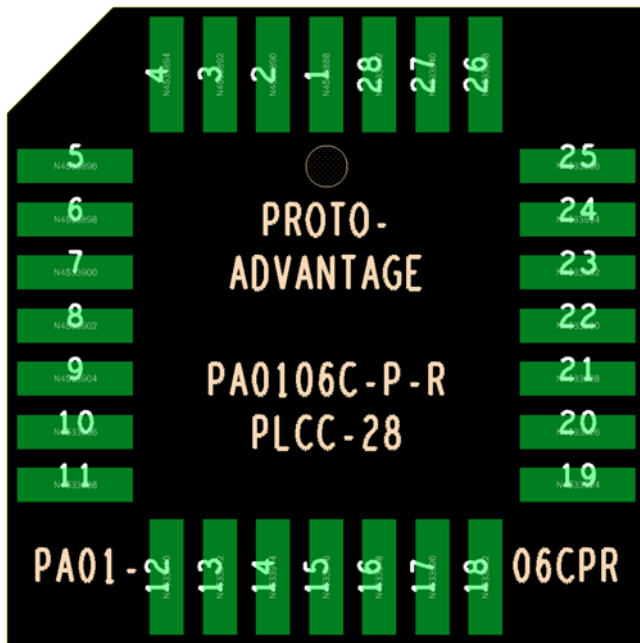

Adapter Pin Out (Bottom Side) (X-Ray View)

