

**Contact Dimensions:**  
**556-Extender Board Bend (Code 520 Contacts)**  
 See Sheet 2 for Contact Code 555, 556, 558, 559, 560 Dimensions

THIS IS A C.A.D. GENERATED DRAWING  
 DO NOT MAKE MANUAL REVISIONS TO MASTER.

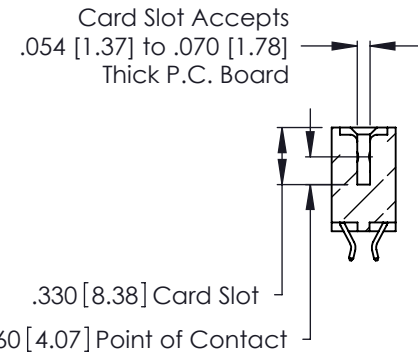

ISSUE NUMBER  
 ORIGINAL ①

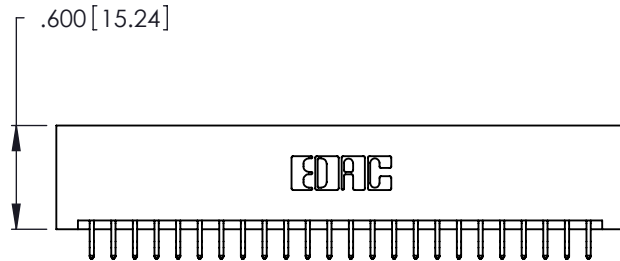
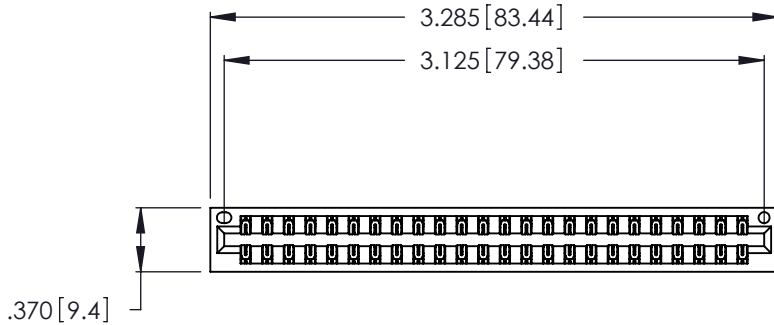

- INSULATOR MATERIAL: THERMOPLASTIC POLYESTER, UL 94V-0
- CONTACT MATERIAL; COPPER, NICKEL, TIN ALLOY CA-725
- CONTACT PLATING: GOLD ON THE MATING AREA, TIN-LEAD ON THE CONTACT TAILS, NICKEL UNDERPLATE

**346/396 SERIES CARD EDGE CONNECTOR**  
**PART NUMBER: 346-048-556-201**



YOUR CONNECTION TO QUALITY & SERVICE

EDAC INC  
 TORONTO, ONTARIO  
 CANADA

THESE DRAWINGS AND SPECIFICATIONS  
 ARE THE PROPERTY OF EDAC INC. AND  
 SHALL NOT BE REPRODUCED, OR COPIED  
 OR USED AS THE BASIS FOR THE  
 MANUFACTURE OR SALE OF APPARATUS  
 WITHOUT WRITTEN PERMISSION.

|                                   |                  |
|-----------------------------------|------------------|
| ACAD REFERENCE NO. 346-ENG-MASTER |                  |
| DRAWN: J.LEE                      | DATE: APR. 22/09 |
| CHECKED:                          | DATE:            |
| SCALE: N.T.S                      | SHEET 1 OF 2     |
| DRAWING NUMBER<br>346-ENG-MASTER  | ISSUE<br>1       |

THIS IS A C.A.D. GENERATED DRAWING  
DO NOT MAKE MANUAL REVISIONS TO MASTER.



|              |   |
|--------------|---|
| ISSUE NUMBER |   |
| ORIGINAL     | ① |



**Contact Code 555**



**Contact Code 556**



**Contact Code 558**



**Contact Code 559**



**Contact Code 560**

- INSULATOR MATERIAL: THERMOPLASTIC POLYESTER, UL 94V-0
- CONTACT MATERIAL: COPPER, NICKEL, TIN ALLOY CA-725
- CONTACT PLATING: GOLD ON THE MATING AREA, TIN-LEAD ON THE CONTACT TAILS, NICKEL UNDERPLATE

|  |  |                    |                |
|--|--|--------------------|----------------|
| <b>346/396 SERIES CARD EDGE CONNECTOR<br/>CONTACT CODE 555,556,558,559,560 DIMENSIONS</b>  |  | ACAD REFERENCE NO. | 346-ENG-MASTER |
|  |  | DRAWN:             | J.LEE          |
|  <b>EDAC INC</b><br>TORONTO, ONTARIO<br>CANADA<br>YOUR CONNECTION TO QUALITY & SERVICE                       |  | CHECKED:           | DATE:          |
|  |  | SCALE:             | 1:1            |
| THESE DRAWINGS AND SPECIFICATIONS ARE THE PROPERTY OF EDAC INC. AND SHALL NOT BE REPRODUCED, OR COPIED OR USED AS THE BASIS FOR THE MANUFACTURE OR SALE OF APPARATUS WITHOUT WRITTEN PERMISSION. |  | DRAWING NUMBER     | ISSUE          |
|  |  | 346-ENG-MASTER     | 1              |