

Adafruit 1.54" eInk Display Breakouts

Created by Melissa LeBlanc-Williams

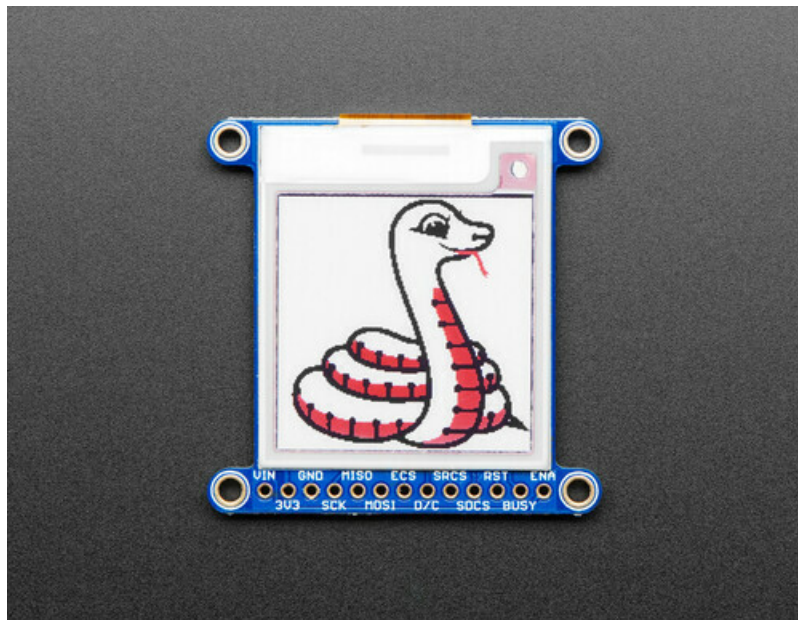

Last updated on 2021-09-14 05:34:22 PM EDT

Guide Contents

Guide Contents	2
Overview	4
We have multiple 1.54" EPD displays:	5
Pinouts	8
Power Pins	8
Data Control Pins	9
Assembly	10
Assembly	10
Add the E-Ink Display	11
And Solder!	11
Wiring	14
Breakout Wiring	14
Python Wiring	14
Usage & Expectations	16
Arduino Setup	17
Arduino Usage	19
1.54" Monochrome 200x200 Pixel Display	19
1.54" Tri-Color 152x152 OR 200x200 Pixel Display	19
Configure Pins	20
Configure Display Type & Size	20
Upload Sketch	21
Arduino Bitmaps	23
CircuitPython Usage	25
CircuitPython elnk displayio Library Installation	25
Adafruit_CircuitPython_SSD1608	25
Adafruit_CircuitPython_IL0373	26
Adafruit_CircuitPython_SSD1681	26
Image File	26
Monochrome Display Usage	26
Configure and Upload	27
Tri-Color Display Usage	27
HD Tri-Color Display	27
Standard Tri-Color Display	27
Configure and Upload	28
Python Setup	29
Python Installation of EPD Library	29
Download font5x8.bin	29
DejaVu TTF Font	30
Pillow Library	30
Python Usage	31
Monochrome Example	32
Tri-Color Example	32
Bitmap Example	33
Full Example Code	38
Image Drawing with Pillow	39
Drawing Shapes and Text with Pillow	44
Downloads	49
Files	49
Display shape/outline:	49

Schematic	49
Fabrication Print	50

Overview

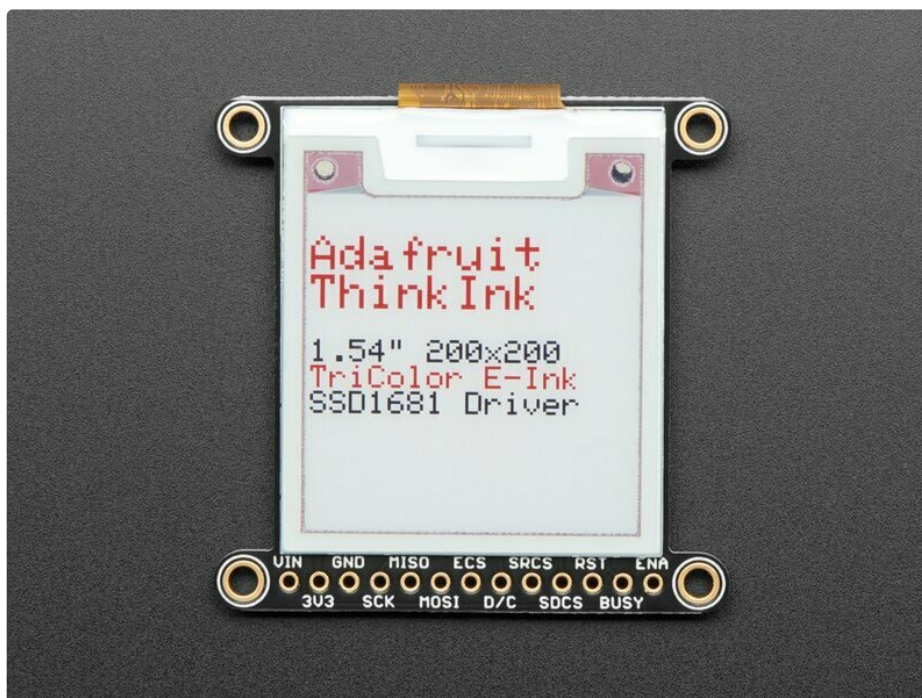

Easy e-paper finally comes to microcontrollers, with these breakouts, shields and friends that are designed to make it a breeze to add a tri-color eInk display. Chances are you've seen one of those new-fangled 'e-readers' like the Kindle or Nook. They have gigantic electronic paper 'static' displays - that means the image stays on the display even when power is completely disconnected. The image is also high contrast and very daylight readable. It really does look just like printed paper!

We've liked these displays for a long time, but they were never designed for makers to use. Finally, we decided to make our own!

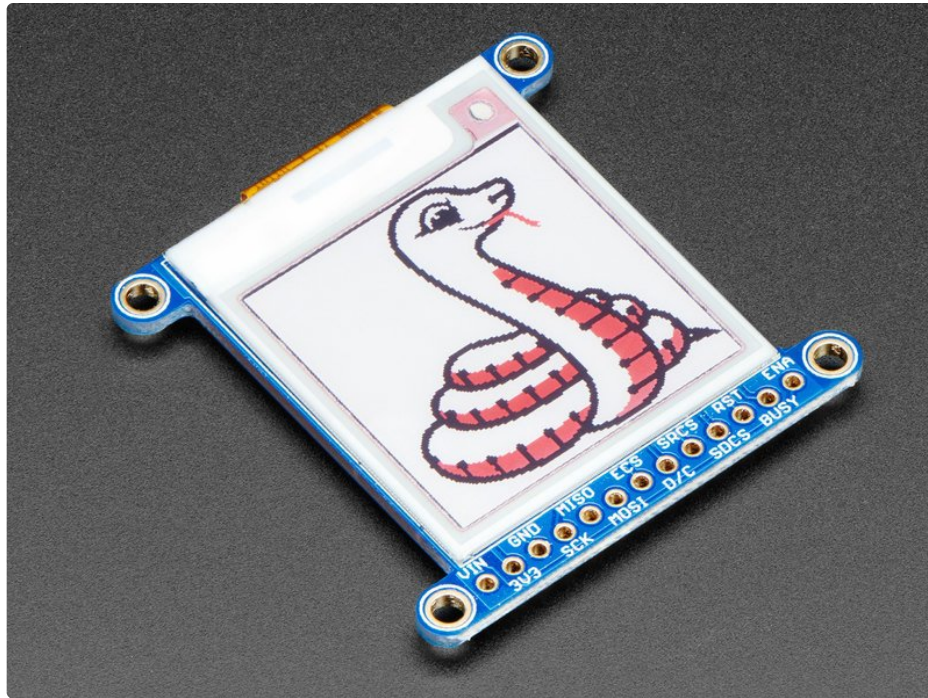

We have multiple 1.54" EPD displays:

- The tri-color have black and red ink pixels and a white-ish background. [We have a 152x152 Tri-Color display \(older, lower res screen\) \(https://adafruit.it/QC0\)](https://adafruit.it/QC0) and a [200x200 Tri-Color display \(newer higher res screen\) \(https://adafruit.it/QC1\)](https://adafruit.it/QC1)
- [The monochrome \(black and white\) display has 200x200 black pixels \(https://adafruit.it/QC2\)](https://adafruit.it/QC2) on a white-ish background. The monochrome displays take a lot less time to update, only a couple seconds instead of 15 seconds!

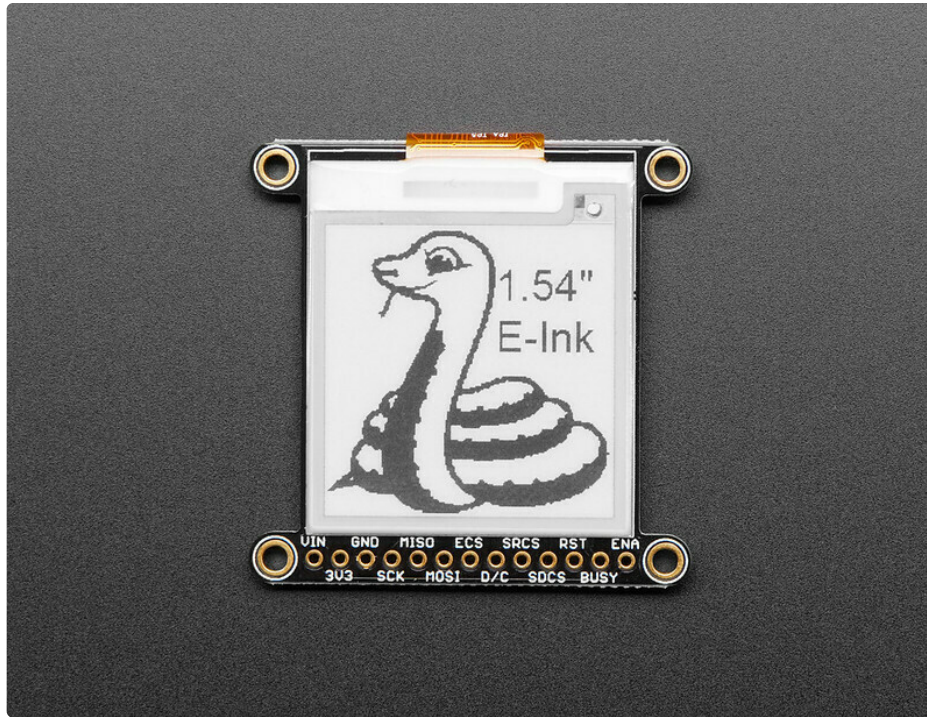

Using our Arduino library, you can create a 'frame buffer' with what pixels you want to have activated and then write that out to the display. Most simple breakouts leave it at that. But if you do the math, using even the smallest 1.54" display: $152 \times 152 \text{ pixels} \times 2 \text{ colors} = 5.7 \text{ KBytes}$. Which won't fit into many microcontroller memories. Heck, even if you do have 32KB of RAM, why waste 6KB?

So we did you a favor and tossed a small SRAM chip on the back. This chip shares the SPI port the elnk display uses, so you only need one extra pin. And, no more frame-buffering! **You can use the SRAM to set up whatever you want to display, then shuffle data from SRAM to elnk when you're ready.** [The library we wrote does all the work for you \(https://adafru.it/BRK\)](https://adafru.it/BRK), you can just interface with it as if it were an [Adafruit GFX compatible display \(https://adafru.it/BRK\)](https://adafru.it/BRK).

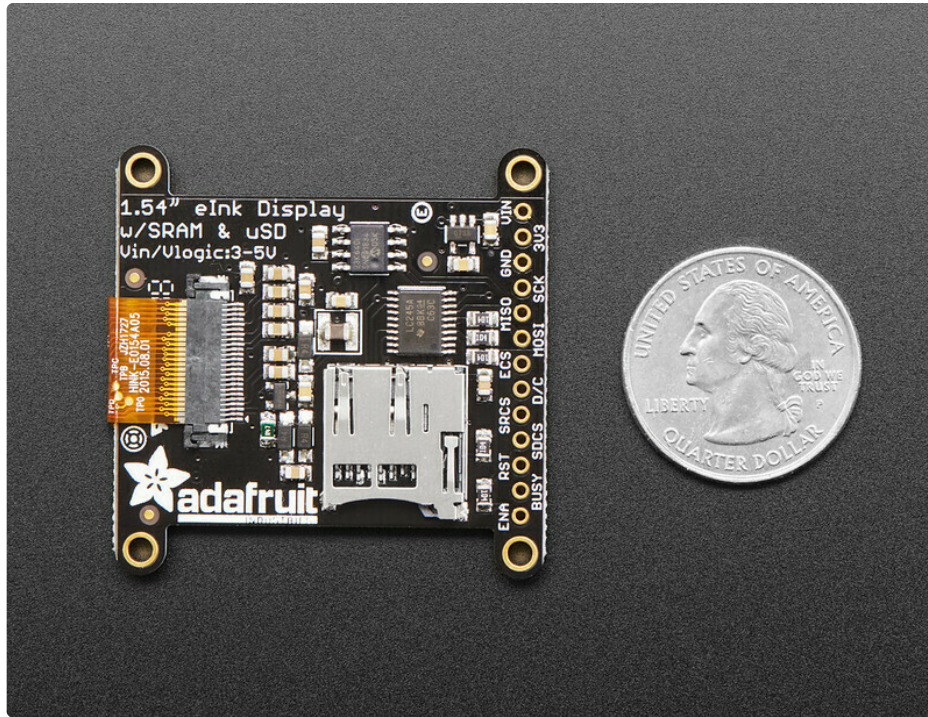

For ultra-low power usages, the onboard 3.3V regulator has the Enable pin brought out so you can shut down the power to the SRAM, MicroSD and display.

We even added on a MicroSD socket so you can store images, text files, whatever you like to display. Everything is 3 or 5V logic safe so you can use it with any and all microcontrollers.

Pinouts

Even though we have multiple 1.54" EPD displays, the pinouts and dimensions are the same for all of them!

This e-Paper display uses SPI to receive image data. Since the display is SPI, it was easy to add two more SPI devices to share the bus - an SPI SRAM chip and SPI-driven SD card holder. There's quite a few pins and a variety of possible combinations for control depending on your needs.

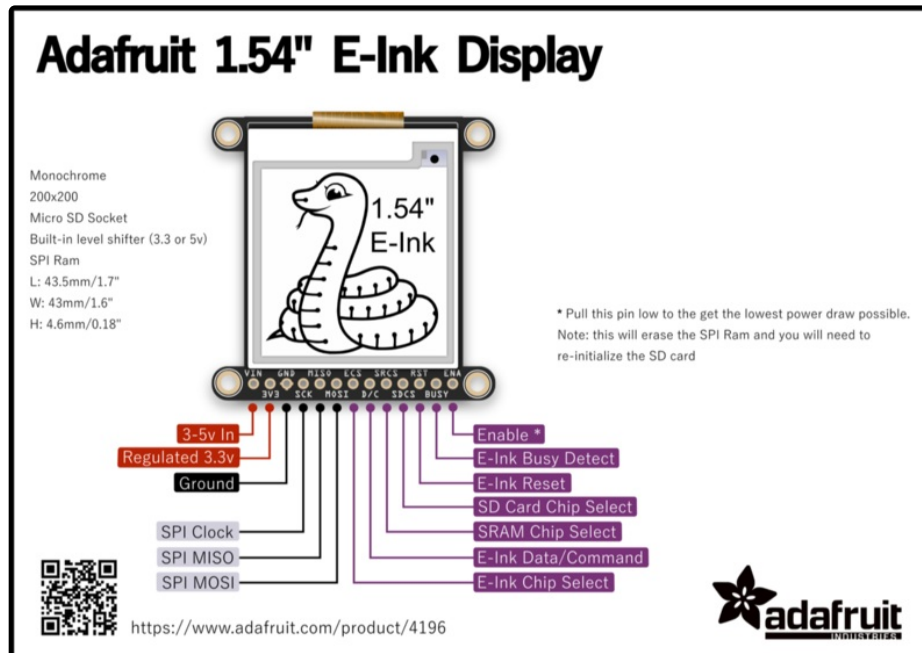

Power Pins



- **3-5V / Vin** - this is the power pin, connect to 3-5VDC - it has reverse polarity protection but try to wire it right!
- **3.3V out** - this is the 3.3V output from the onboard regulator, you can 'borrow' about 100mA if you need to power some other 3.3V logic devices
- **GND** - this is the power and signal ground pin
- **ENable** - This pin is all the way on the right. It is connected to the enable pin on the onboard

regulator that powers everything. If you want to *really* have the lowest possible power draw, pull this pin low! Note that if you do so you will cut power to the eInk display but also the SPI RAM (thus erasing it) and the SD card (which means you'll have to re-initialize it when you re-power

Data Control Pins



- **SCK** - this is the SPI clock input pin, required for e-Ink, SRAM and SD card
- **MISO** - this is the SPI Microcontroller In Serial Out pin, its used for the SD card and SRAM. It isn't used for the e-Ink display which is write-only, however you'll likely be using the SRAM to buffer the display so connect this one too!
- **MOSI** - this is the SPI Microcontroller Out Serial In pin, it is used to send data from the microcontroller to the SD card, SRAM and e-Ink display
- **ECS** - this is the **E**-Ink **C**hip **S**elect, required for controlling the display
- **D/C** - this is the e-Ink **D**ata/**C**ommand pin, required for controlling the display
- **SRCS** - this is the **S**RAM **C**hip **S**elect, required for communicating with the onboard RAM chip.
- **SDCS** - this is the **S**D card **C**hip **S**elect, required for communicating with the onboard SD card holder. You can leave this disconnected if you aren't going to access SD cards
- **RST** - this is the E-Ink **R**e**S**e**T** pin, you may be able to share this with your microcontroller reset pin but if you can, connect it to a digital pin.
- **BUSY** - this is the e-Ink busy detect pin, and is optional if you don't want to connect the pin (in which case the code will just wait an approximate number of seconds)

Assembly

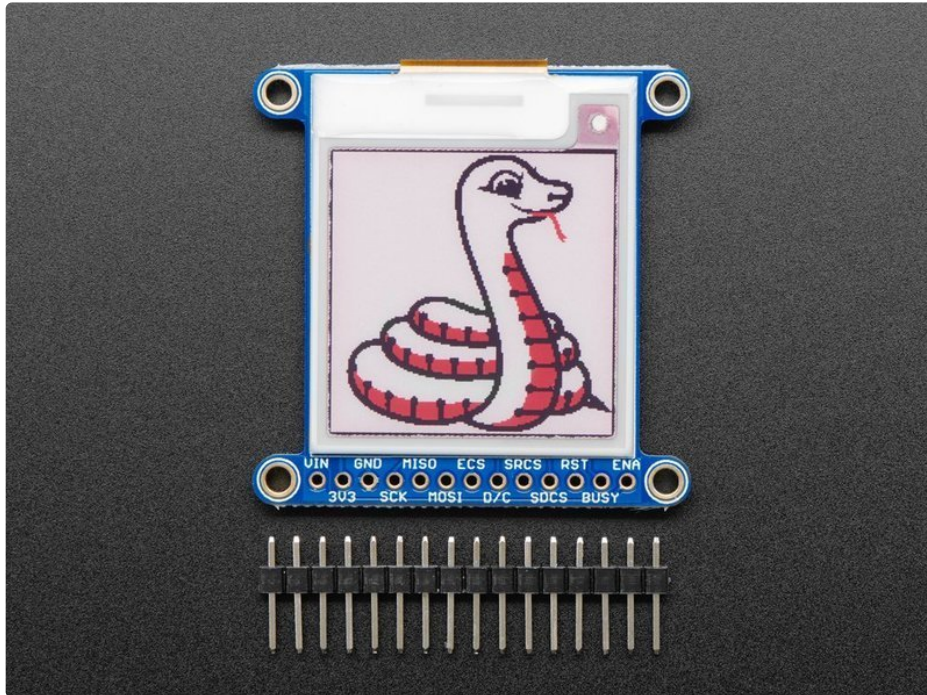

Assembly

Cut the header down to length if necessary. It will be easier to solder if you insert it into a breadboard - long pins down

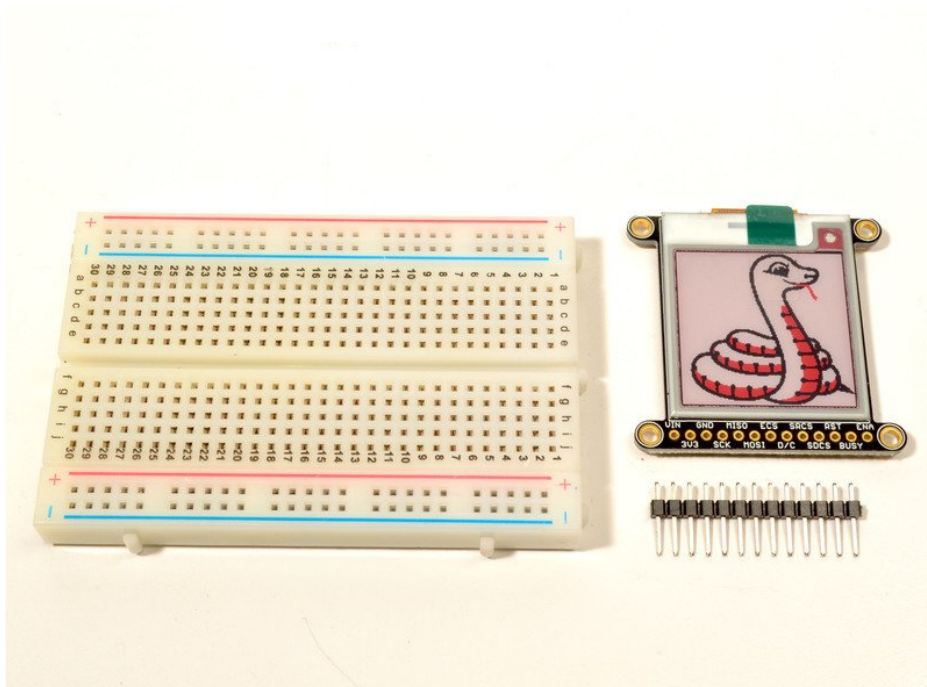

Add the E-Ink Display

Place the board over the pins so that the short pins poke through the top of the breakout pads

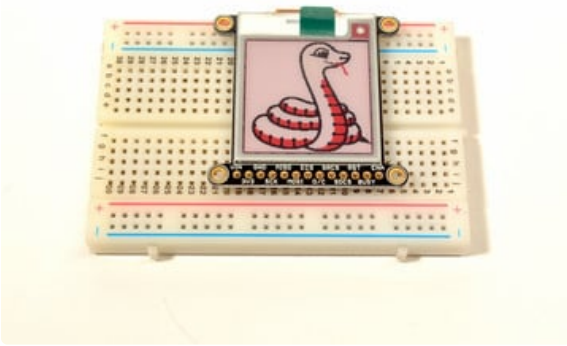

And Solder!

Be sure to solder all pins for reliable electrical contact.

(For tips on soldering, be sure to check out the [Guide to Excellent Soldering](https://adafruit.it/aTk) (<https://adafruit.it/aTk>)).

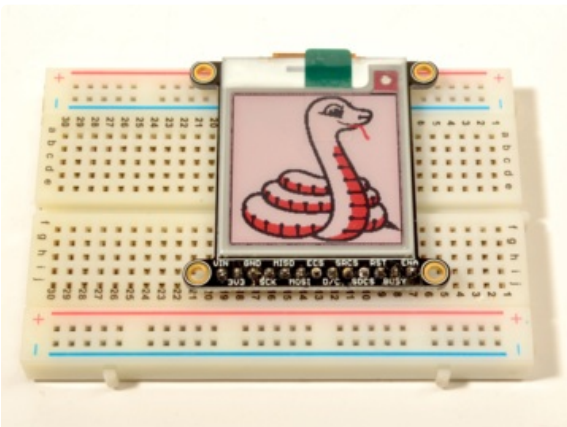
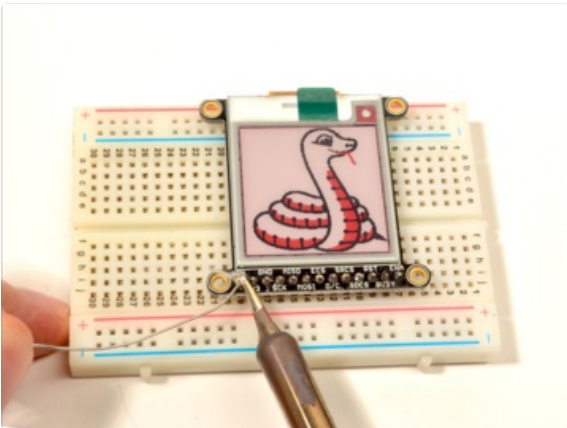
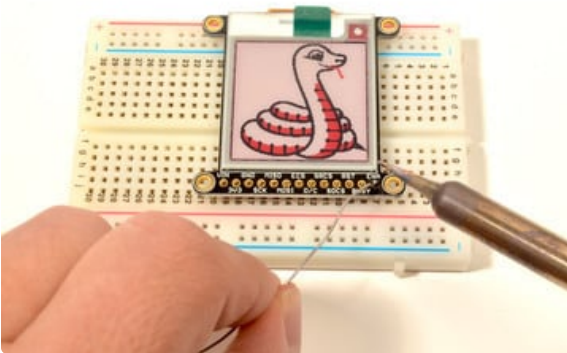

OK, you're done!

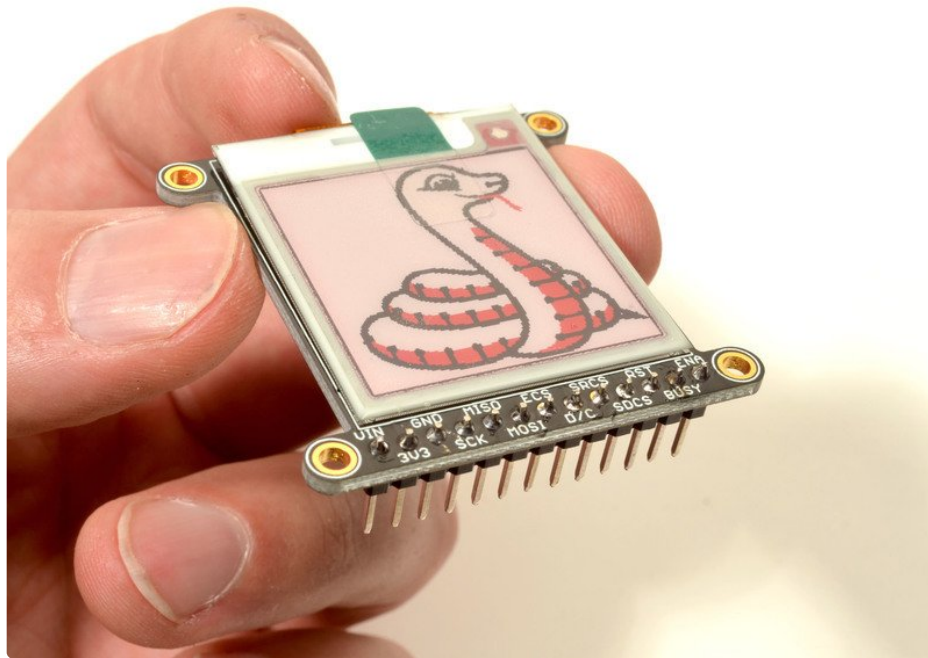

Wiring

Breakout Wiring

Wiring up the display in SPI mode is pretty easy as there's not that many pins! We'll be using hardware SPI, but you can also use software SPI (any pins) later.

- **Vin** connects to the microcontroller board's **5V** or **3.3V** power supply pin
- **GND** connects to ground
- **CLK** connects to SPI clock. It's easiest to connect it to **pin 3 of the ICSP header**.
- **MOSI** connects to SPI MOSI. It's easiest to connect it to **pin 4 of the ICSP header**.
- **MISO** connects to SPI MISO. It's easiest to connect it to **pin 1 of the ICSP header**.
- **ECS** connects to our e-Ink Chip Select pin. We'll be using **Digital 9**
- **D/C** connects to our e-Ink data/command select pin. We'll be using **Digital 10**.
- **SRCS** connects to our SRAM Chip Select pin. We'll be using **Digital 6**
- **RST** connects to our e-Ink reset pin. We'll be using **Digital 8**.
- **BUSY** connects to our e-Ink busy pin. We'll be using **Digital 7**.
- **SDCS** connects to our SD Card Chip Select pin. We'll be using **Digital 5**

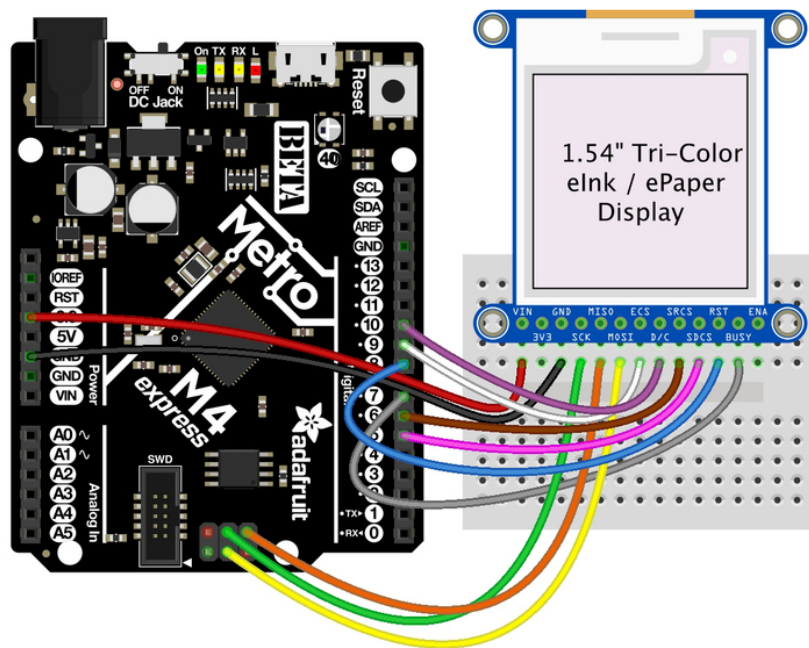

fritzing

Python Wiring

- **Raspberry Pi 3.3** to display **VIN**
- **Raspberry Pi GND** to display **GND**

- Raspberry Pi SCLK to display SCK
- Raspberry Pi MOSI to display MOSI
- Raspberry Pi GPIO CE0 to display ECS
- Raspberry Pi GPIO 22 to display D/C
- Raspberry Pi GPIO 27 to display RST
- Raspberry Pi GPIO 17 to display BUSY

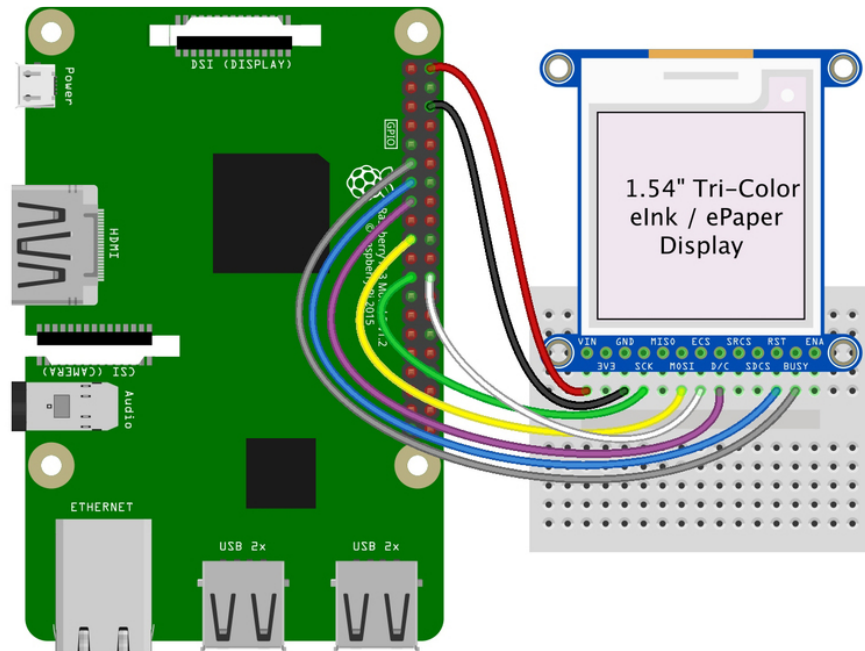

fritzing

Usage & Expectations

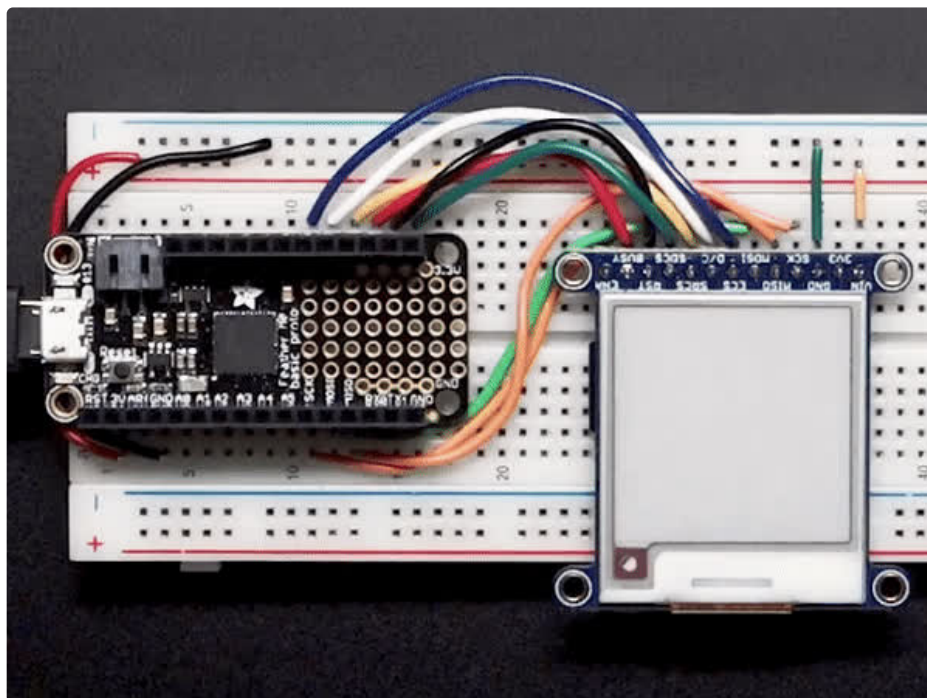

One thing to remember with these small e-Ink screens is that its *very slow* compared to OLEDs, TFTs, or even 'memory displays'. **It will take many seconds to fully erase and replace an image**

There's also a recommended limit on refreshing - **you shouldn't refresh or change the display more than every 3 minutes (180 seconds).**

You don't have to refresh often, but with tri-color displays, the larger red ink dots will slowly rise, turning the display pinkish instead of white background. **To keep the background color clear and pale, refresh once a day**

Do not update more than once every 180 seconds or you may permanently damage the display

Arduino Setup

To use the display, you will need to [install the Adafruit EPD library \(code on our github repository\) \(https://adafru.it/BRK\)](https://adafru.it/BRK). It is available from the Arduino library manager so we recommend using that.

From the IDE open up the library manager...

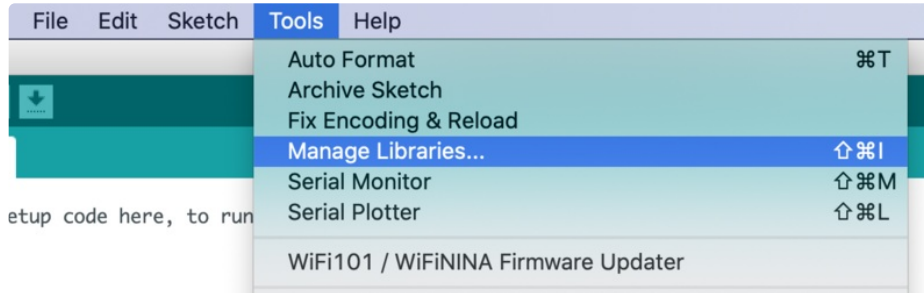

And type in **adafruit EPD** to locate the library. Click **Install**

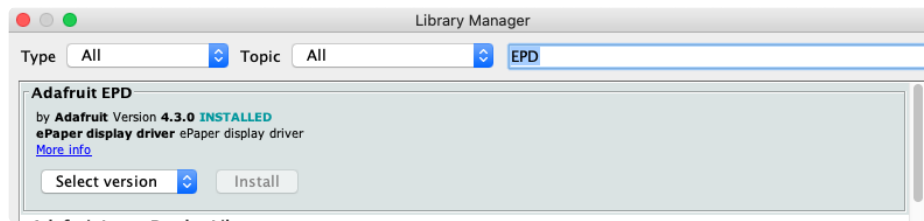

If you would like to draw bitmaps, do the same with **adafruit ImageReader**, click **Install**

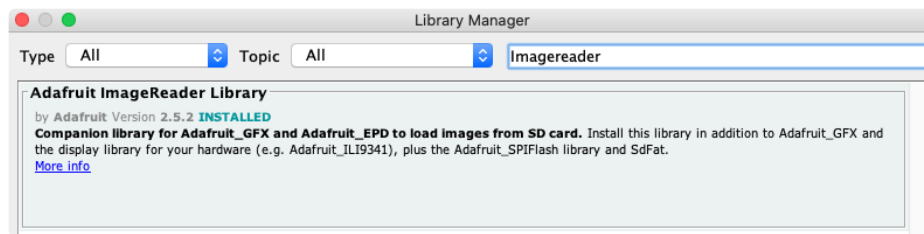

Do the same to install the latest **adafruit GFX** library, click **Install**

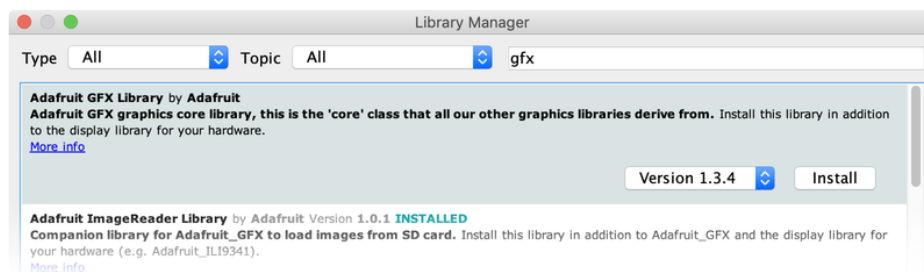

If using an earlier version of the Arduino IDE (pre-1.8.10), locate and install **Adafruit_BusIO** (newer versions handle this prerequisite automatically).

Arduino Usage

Here is where the differences in the tri-color/monochrome and chipset/dimensions start mattering. Check carefully to make sure you are running the right example and creating the matching ThinkInk type for your display or you wont see anything happen on the EPD (or the image may be really weird looking)

1.54" Monochrome 200x200 Pixel Display

For the [200 x 200 monochrome display \(https://adafru.it/QC2\)](https://adafru.it/QC2) we will run a monochrome demo.

Adafruit 1.54" Monochrome eInk / ePaper Display with SRAM

Easy e-paper finally comes to microcontrollers, with this breakout that's designed to make it a breeze to add a eInk display. Chances are you've seen one of those new-fangled...

\$24.95

In Stock

Add to Cart

Open up **File**→**Examples**→**Adafruit_EPD**→**ThinkInk_mono**

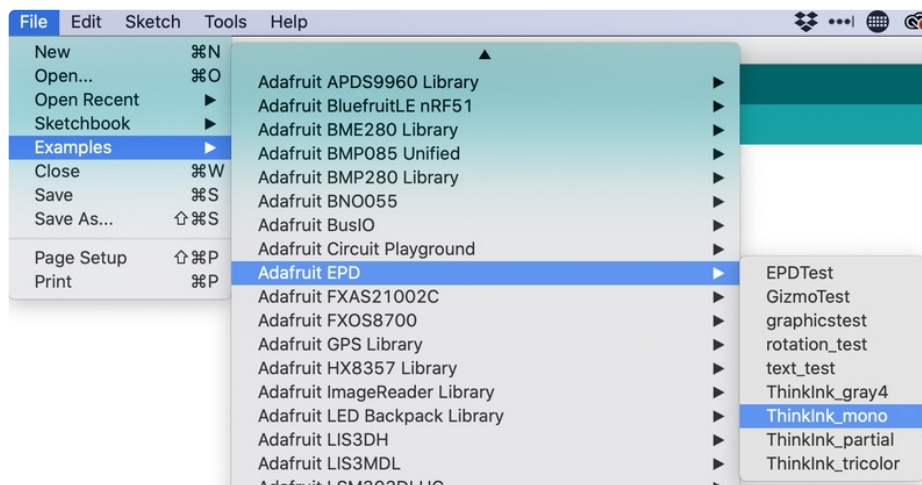

1.54" Tri-Color 152x152 OR 200x200 Pixel Display

For the 152x152 OR 200x200 Tri-Color display, we will run the tricolor demo.

Adafruit 1.54" 152x152 Tri-Color eInk / ePaper Display with SRAM

Easy e-paper finally comes to microcontrollers, with this breakout that's designed to make it a breeze to add a tri-color eInk display. Chances are you've seen one of those...

\$22.50

In Stock

Add to Cart

Your browser does not support the video tag.

Adafruit 1.54" Tri-Color eInk / ePaper 200x200 Display with SRAM

Easy e-paper finally comes to microcontrollers, with this breakout that's designed to make it a breeze to add a tri-color eInk display. Chances are you've seen one of those...

\$19.95

In Stock

Add to Cart

Open up **File**→**Examples**→**Adafruit_EPD**→**ThinkInk_tricolor**

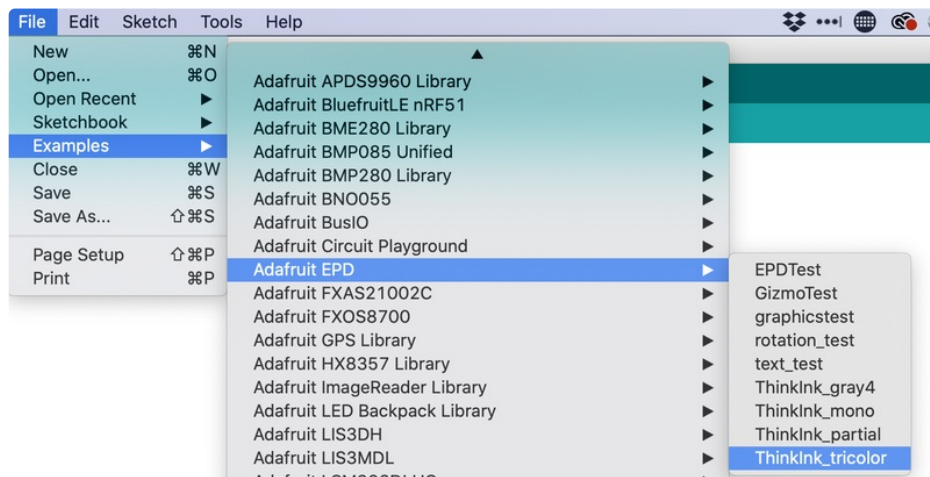

Configure Pins

No matter what display you have, you will need to verify that your pins match your wiring. At the top of the sketch find the lines that look like:

```
#define EPD_DC      10
#define EPD_CS      9
#define SRAM_CS     6
#define EPD_RESET   8 // can set to -1 and share with microcontroller Reset!
#define EPD_BUSY    7 // can set to -1 to not use a pin (will wait a fixed delay)
```

If you wired the display differently than on the wiring page, adjust the pin numbers accordingly.

Configure Display Type & Size

Find the part of the script where you can pick which display is going to be used. The eInk displays are made up a combination of a Chipset and a Film in different sizes. We have narrowed it down to just a few

choices between the size of the display, chipset, and film based on available combinations. In the sketch, we have sorted it by size, so it's easy to find your display.

You will need to uncomment the appropriate initializer and and leave any other type commented.

For the [1.54" 200x200 Monochrome breakout](https://adafru.it/QC2) (https://adafru.it/QC2) you will use `ThinkInk_154_Mono_D27` display initializer.

For the [1.54" 152x152 Tri-Color breakout](https://adafru.it/QC0) (https://adafru.it/QC0), you will use the `ThinkInk_154_Tricolor_Z17` display initializer.

For the [1.54" 200x200 Tri-Color breakout](https://adafru.it/QC1) (https://adafru.it/QC1), you will use the `ThinkInk_154_Tricolor_Z90` display initializer.

For example, for the monochrome 200x200, uncomment this line, and comment any other line that is creating a ThinkInk display object

```
// 1.54" Monochrome displays with 200x200 pixels and SSD1608 chipset
ThinkInk_154_Mono_D27 display(EPD_DC, EPD_RESET, EPD_CS, SRAM_CS, EPD_BUSY);
```

Upload Sketch

Go ahead and upload the sketch to your board. Once it is done uploading, open the **Serial Monitor**.

The display should start running a series of monochrome tests

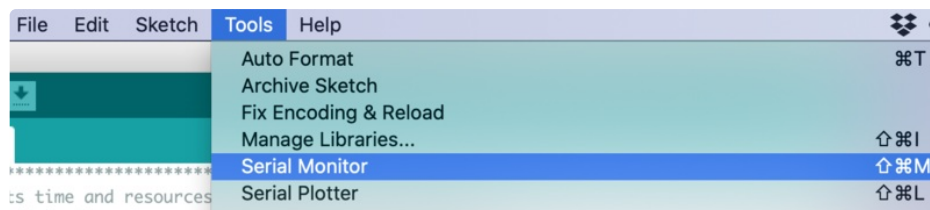



Arduino Bitmaps

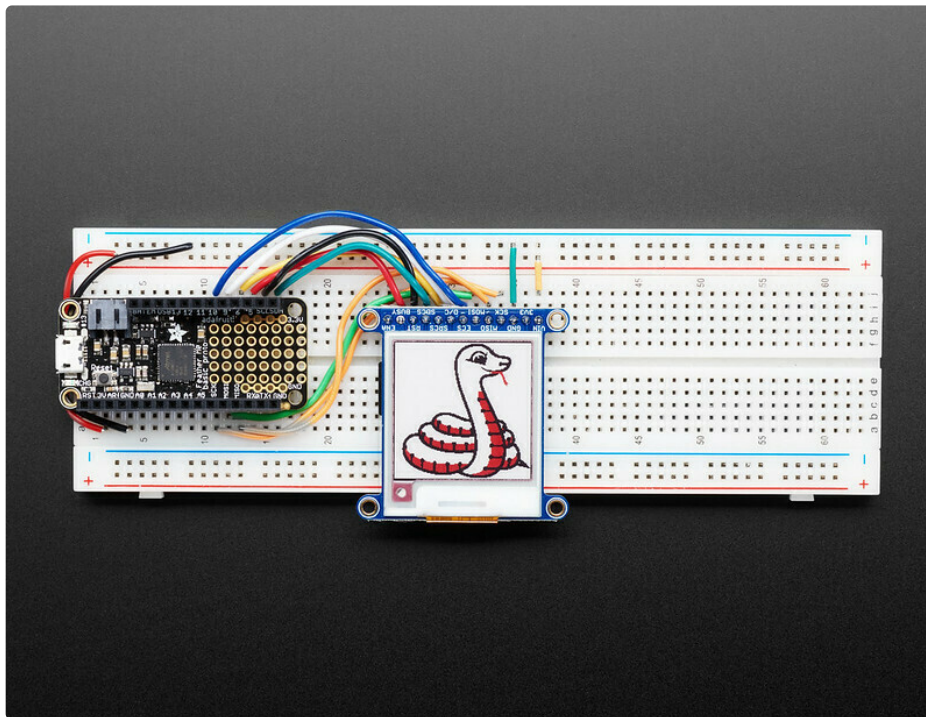

Not only can you draw shapes but you can also load images from the SD card, perfect for static images!

The 1.54" Monochrome display can show a max of 200x200 pixels and the Standard 1.54" Tri-Color display can show a max of 152x152 pixels and the HD Tri-Color version can show a max of 200x200 pixels. Let's use this Blinka bitmap for our demo. Select the one that is the correct size:

<https://adafruit.it/QC3>

<https://adafruit.it/QC3>

<https://adafruit.it/QC4>

<https://adafruit.it/QC4>

<https://adafruit.it/QC7>

<https://adafruit.it/QC7>

Download the **blinka.bmp** file and place it into the base directory of a microSD card and insert it into the microSD socket in the breakout.

Plug the MicroSD card into the display. You may want to try the **SD library** examples before continuing, especially one that lists all the files on the SD card

Open the file->examples->Adafruit_ImageReader->ThinkInkDisplays example

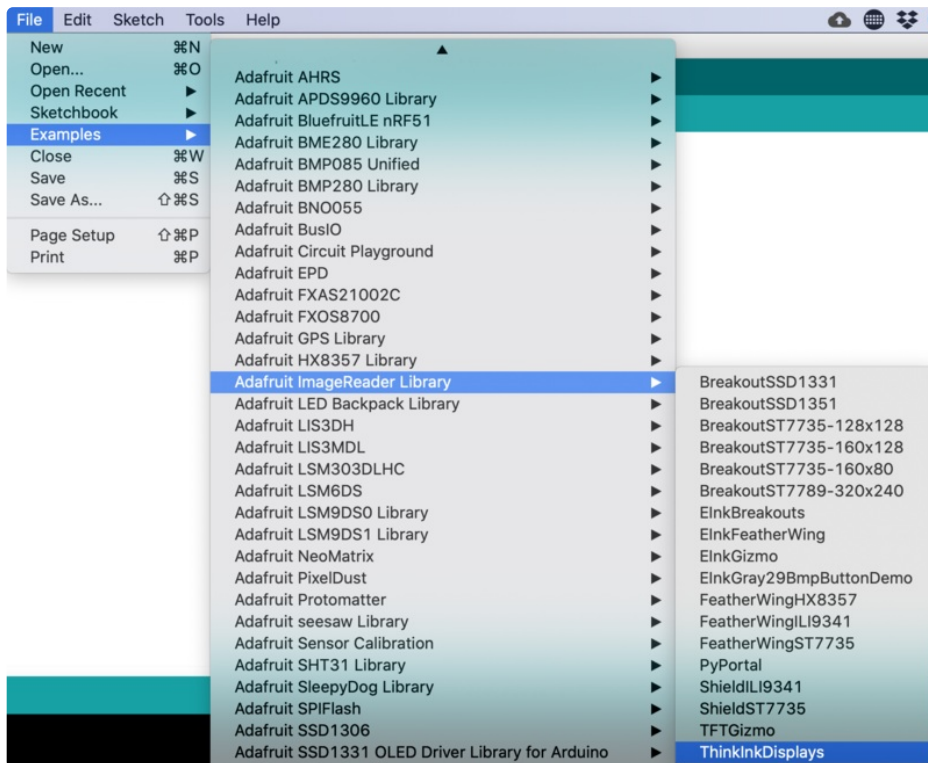

Upload to your board and you should see an image of Blinka appear.

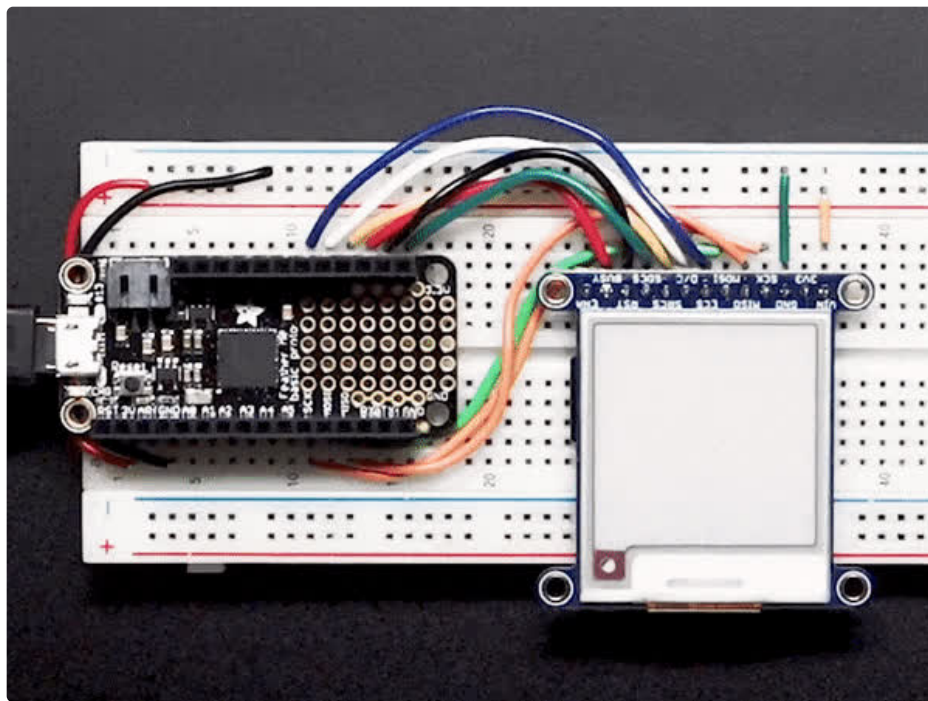

CircuitPython Usage

Here is where the differences in the tri-color/monochrome and chipset/dimensions start mattering. Check carefully to make sure you are running the right example and creating the matching library type for your display or you wont see anything happen on the EPD (or the image may be really weird looking)

CircuitPython eInk displayio Library Installation

To use displayio, you will need to install the appropriate library for your display.

First make sure you are running the [latest version of Adafruit CircuitPython](https://adafru.it/Amd) for your board. You will need the latest version of CircuitPython.

Next you'll need to install the necessary libraries to use the hardware--carefully follow the steps to find and install these libraries from [Adafruit's CircuitPython library bundle](https://adafru.it/zdx). Our introduction guide has [a great page on how to install the library bundle](https://adafru.it/ABU) for both express and non-express boards.

You will need to copy the appropriate displayio driver from the bundle **lib** folder to a **lib** folder on your **CIRCUITPY** drive. The displayio driver contains the initialization codes specific to your display that are needed to for it to work. Since there is more than one driver, you will need to copy the correct file over. Here is a list of each of the displays and the correct driver for that display.

To use the eInk displays with displayio, you will need to use the latest version of CircuitPython and a board that can fit `displayio`. See the Support Matrix to determine if `displayio` is available on a given board: https://circuitpython.readthedocs.io/en/latest/shared-bindings/support_matrix.html

Adafruit_CircuitPython_SSD1608

[The 200x200 monochrome display with SSD1608 driver](https://adafru.it/QC2) uses the **Adafruit_CircuitPython_SSD1608** library. Copy the `adafruit_ssd1608.mpy` file from the bundle to the **lib** folder on your **CIRCUITPY** drive.

Adafruit 1.54" Monochrome eInk / ePaper Display with SRAM

Easy e-paper finally comes to microcontrollers, with this breakout that's designed to make it a breeze to add a eInk display. Chances are you've seen one of those new-fangled...

\$24.95

In Stock

Add to Cart

Adafruit_CircuitPython_IL0373

[The 152x152 Tri-Color display with IL0373 \(https://adafru.it/QC0\)](https://adafru.it/QC0) uses the `Adafruit_CircuitPython_ILI0373` library. Copy the `adafruit_il0373.mpy` file from the bundle to the `lib` folder on your `CIRCUITPY` drive.

Adafruit 1.54" 152x152 Tri-Color eInk / ePaper Display with SRAM

Easy e-paper finally comes to microcontrollers, with this breakout that's designed to make it a breeze to add a tri-color eInk display.

Chances are you've seen one of those...

\$22.50

In Stock

Add to Cart

Adafruit_CircuitPython_SSD1681

[The 200x200 Tri-Color display with SSD1681 driver \(https://adafru.it/QC1\)](https://adafru.it/QC1) uses the `Adafruit_CircuitPython_SSD1681` library. Copy the `adafruit_ssd1681.mpy` file from the bundle to the `lib` folder on your `CIRCUITPY` drive.

Your browser does not support the video tag.

Adafruit 1.54" Tri-Color eInk / ePaper 200x200 Display with SRAM

Easy e-paper finally comes to microcontrollers, with this breakout that's designed to make it a breeze to add a tri-color eInk display.

Chances are you've seen one of those...

\$19.95

In Stock

Add to Cart

Image File

To show you how to use the eInk with displayio, we'll show you how to draw a bitmap onto it. First start by downloading `display-ruler.bmp`

<https://adafru.it/U1a>

<https://adafru.it/U1a>

Copy `display-ruler.bmp` into the root directory of your `CIRCUITPY` drive.

Monochrome Display Usage

In the examples folder for your SSD1608 displayio driver, there should be a test for your display which we have listed here:

Temporarily unable to load content:

Configure and Upload

You will want to change the `epd_reset` and `epd_busy` to the correct values. If you wired it up as shown on the Wiring page, you will want to change it to these values:

```
epd_reset = board.D8
epd_busy = board.D7
```

Save it to your **CIRCUITPY** drive as `code.py` and it should automatically run. Your display will look something like this:

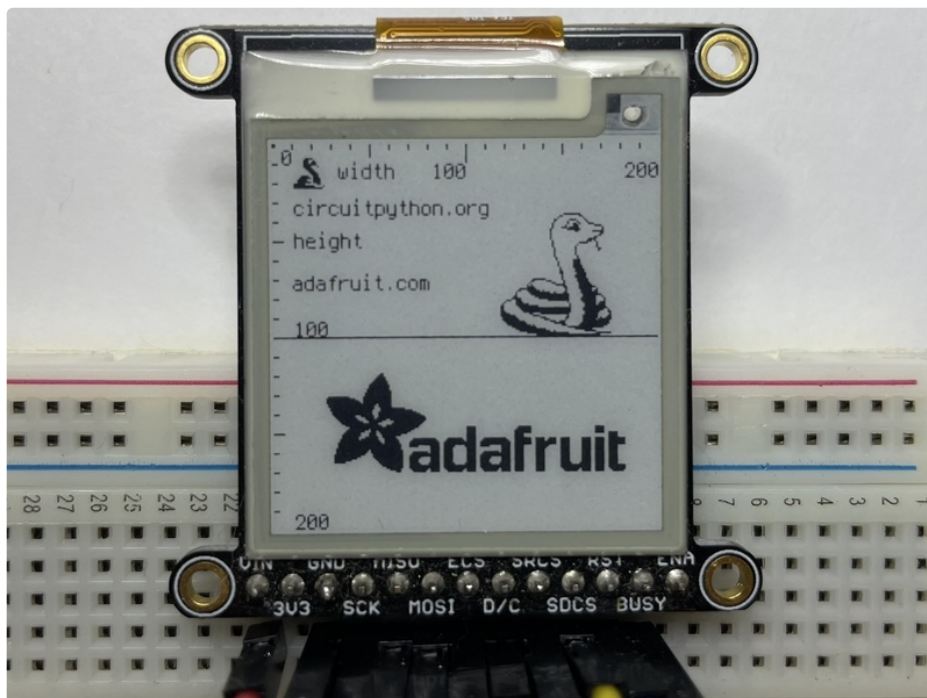

Tri-Color Display Usage

HD Tri-Color Display

In the examples folder for your SSD1681 displayio driver, there should be a test for your display which we have listed here:

Temporarily unable to load content:

Standard Tri-Color Display

In the examples folder for your ILI0373 displayio driver, there should be a test for your display which we have listed here:

Temporarily unable to load content:

Configure and Upload

For either display, you will want to change the `epd_reset` and `epd_busy` to the correct values. If you wired it up as shown on the Wiring page, you will want to change it to these values:

```
epd_reset = board.D8  
epd_busy = board.D7
```

Save it to your **CIRCUITPY** drive as `code.py` and it should automatically run. Your display will look something like this:

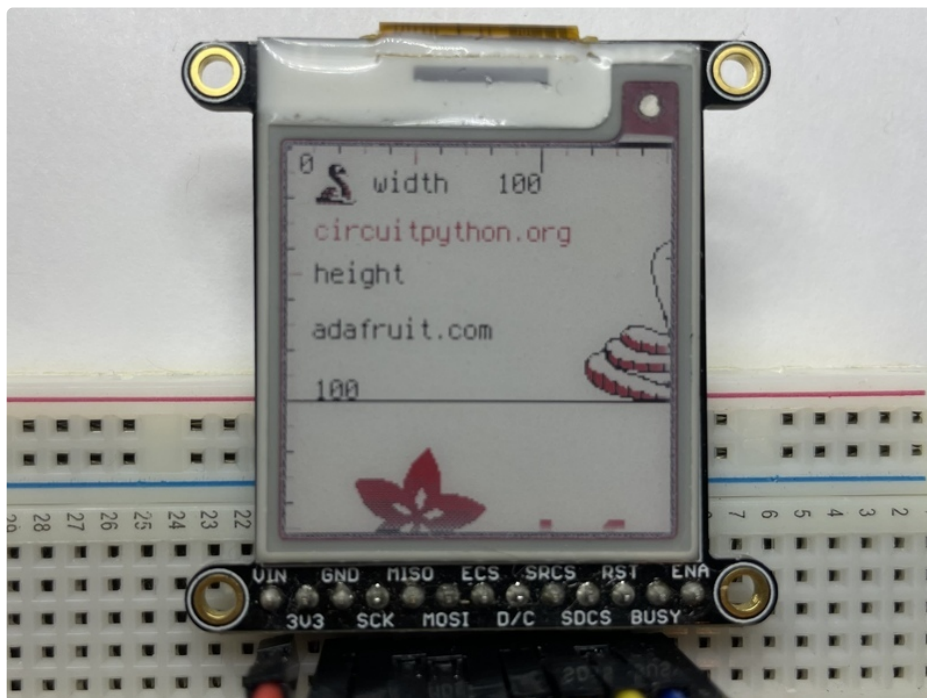

Python Setup

It's easy to use eInk breakouts with Python and the [Adafruit CircuitPython EPD](https://adafru.it/BTd) (<https://adafru.it/BTd>) library. This library allows you to easily write Python code to control the display.

Since there's *dozens* of Linux computers/boards you can use we will show wiring for Raspberry Pi. For other platforms, [please visit the guide for CircuitPython on Linux to see whether your platform is supported](https://adafru.it/BSN) (<https://adafru.it/BSN>).

Note this is not a kernel driver that will let you have the console appear on the eInk. However, this is handy when you want to use the eInk display purely from 'user Python' code!

You can only use this technique with Linux/computer devices that have hardware SPI support, and not all single board computers have an SPI device, so check before continuing

You'll need to install the **Adafruit_Blinka** library that provides the CircuitPython support in Python. This may also require enabling SPI on your platform and verifying you are running Python 3. [Since each platform is a little different, and Linux changes often, please visit the CircuitPython on Linux guide to get your computer ready](https://adafru.it/BSN) (<https://adafru.it/BSN>)!

Python Installation of EPD Library

Once that's done, from your command line run the following command:

- `sudo pip3 install adafruit-circuitpython-epd`

If your default Python is version 3 you may need to run 'pip' instead. Just make sure you aren't trying to use CircuitPython on Python 2.x, it isn't supported!

If that complains about pip3 not being installed, then run this first to install it:

- `sudo apt-get install python3-pip`

Download font5x8.bin

This library also requires a font file to run! You can download it below. Before continuing, make sure the folder you are running scripts from contains the **font5x8.bin** file.

<https://adafru.it/Gfb>

DejaVu TTF Font

Raspberry Pi usually comes with the DejaVu font already installed, but in case it didn't, you can run the following to install it:

- `sudo apt-get install ttf-dejavu`

Pillow Library

Some of the examples also use PIL, the Python Imaging Library, to allow graphics and using text with custom fonts. There are several system libraries that PIL relies on, so installing via a package manager is the easiest way to bring in everything:

- `sudo apt-get install python3-pil`

That's it. You should be ready to go.

Python Usage

Note this is not a kernel driver that will let you have the console appear on the eInk. However, this is handy when you want to use the eInk display purely from 'user Python' code!

You can only use this technique with Linux/computer devices that have hardware SPI support, and not all single board computers have an SPI device, so check before continuing

To demonstrate the usage of the display, we'll initialize it and draw some lines from the Python REPL.

Run the following code to import the necessary modules and set up the pin assignments. We set the SRAM CS pin to `None` because the Raspberry Pi has lots of RAM, so we don't really need it.

```
import digitalio
import busio
import board
from adafruit_epd.epd import Adafruit_EPd

spi = busio.SPI(board.SCK, MOSI=board.MOSI, MISO=board.MISO)
ecs = digitalio.DigitalInOut(board.CE0)
dc = digitalio.DigitalInOut(board.D22)
rst = digitalio.DigitalInOut(board.D27)
busy = digitalio.DigitalInOut(board.D17)
srcs = None
```

Depending on the exact E-Ink display you're using, the driver and object initialization will differ a bit because we have to tell Python what the chip driver is, and what the size of the display is!

Run the following code to initialize the Monochrome display:

Adafruit 1.54" Monochrome eInk / ePaper Display with SRAM

Easy e-paper finally comes to microcontrollers, with this breakout that's designed to make it a breeze to add a eInk display. Chances are you've seen one of those new-fangled...

\$24.95

In Stock

Add to Cart

```
from adafruit_epd.ssd1608 import Adafruit_SSD1608

display = Adafruit_SSD1608(200, 200, spi, cs_pin=ecs, dc_pin=dc, sramcs_pin=srcs, rst_pin=rst,
    busy_pin=busy)
```

Run the following code to initialize the lower-res Tri-Color display:

[Adafruit 1.54" 152x152 Tri-Color eInk / ePaper Display with SRAM](#)

Easy e-paper finally comes to microcontrollers, with this breakout that's designed to make it a breeze to add a tri-color eInk display. Chances are you've seen one of those...

\$22.50

In Stock

Add to Cart

```
from adafruit_epd.il0373 import Adafruit_IL0373
display = Adafruit_IL0373(152, 152, spi, cs_pin=ecs, dc_pin=dc, sramcs_pin=sracs, rst_pin=rst,
    busy_pin=busy)
```

Run the following code to initialize the newer high-res Tri-Color display:

Your browser does not support the video tag.

[Adafruit 1.54" Tri-Color eInk / ePaper 200x200 Display with SRAM](#)

Easy e-paper finally comes to microcontrollers, with this breakout that's designed to make it a breeze to add a tri-color eInk display. Chances are you've seen one of those...

\$19.95

In Stock

Add to Cart

```
from adafruit_epd.ssd1681 import Adafruit_SSD1681

display = Adafruit_SSD1681(200, 200, spi, cs_pin=ecs, dc_pin=dc, sramcs_pin=sracs, rst_pin=rst,
    busy_pin=busy)
```

Monochrome Example

Now we can clear the screens buffer and draw some shapes. Once we're done drawing, we need to tell the screen to update using the `display()` method.

```
display.rotation = 2
display.fill(Adafruit_EPD.WHITE)

display.fill_rect(20, 20, 50, 60, Adafruit_EPD.BLACK)
display.hline(80, 30, 60, Adafruit_EPD.BLACK)
display.vline(80, 30, 60, Adafruit_EPD.BLACK)

display.display()
```

Tri-Color Example

The Tri-Color example is almost the same as the monochrome example, except we added another color in. Once we're done drawing, we need to tell the screen to update using the `display()` method.

```
display.rotation = 2
display.fill(Adafruit_EPDM_WHITE)

display.fill_rect(20, 20, 50, 60, Adafruit_EPDM_RED)
display.hline(80, 30, 60, Adafruit_EPDM_BLACK)
display.vline(80, 30, 60, Adafruit_EPDM_BLACK)

display.display()
```

Your display will look something like this:

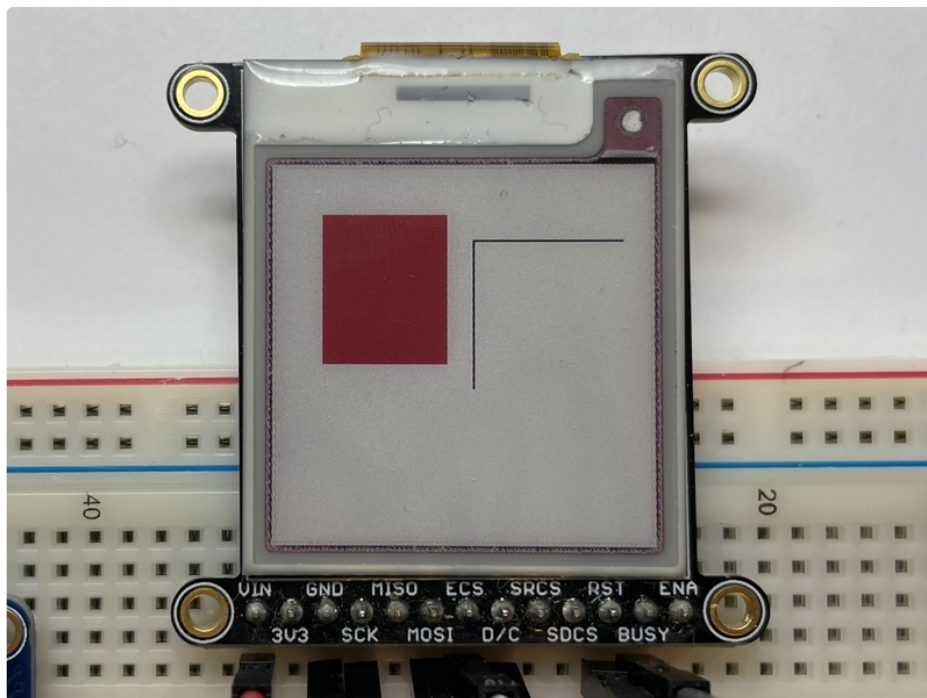

That's all there is to drawing simple shapes with eInk displays and CircuitPython!

Bitmap Example

Here's a complete example of how to display a bitmap image on your display. **Note that any .bmp image you want to display must be exactly the size of your display.** We will be using the image below on the 1.54" display. Click the button below to download the image and save it as `blinka.bmp` on your **Raspberry Pi**. We will be using a Tri-Color bitmap, but it should still work on a monochrome display.

<https://adafru.it/QEy>

<https://adafru.it/QEy>

Save the following code to your Raspberry Pi as `epd_bitmap.py`.

```
# SPDX-FileCopyrightText: 2021 ladyada for Adafruit Industries
# SPDX-License-Identifier: MIT

import digitalio
import busio
import board
from adafruit_epd.epd import Adafruit_EPD
from adafruit_epd.il0373 import Adafruit_IL0373
from adafruit_epd.il91874 import Adafruit_IL91874 # pylint: disable=unused-import
from adafruit_epd.il0398 import Adafruit_IL0398 # pylint: disable=unused-import
from adafruit_epd.ssd1608 import Adafruit_SSD1608 # pylint: disable=unused-import
from adafruit_epd.ssd1675 import Adafruit_SSD1675 # pylint: disable=unused-import
from adafruit_epd.ssd1680 import Adafruit_SSD1680 # pylint: disable=unused-import
from adafruit_epd.ssd1681 import Adafruit_SSD1681 # pylint: disable=unused-import

# create the spi device and pins we will need
spi = busio.SPI(board.SCK, MOSI=board.MOSI, MISO=board.MISO)
ecs = digitalio.DigitalInOut(board.D10)
dc = digitalio.DigitalInOut(board.D9)
srcs = digitalio.DigitalInOut(board.D7) # can be None to use internal memory
rst = digitalio.DigitalInOut(board.D11) # can be None to not use this pin
busy = digitalio.DigitalInOut(board.D12) # can be None to not use this pin

# give them all to our driver
print("Creating display")
# display = Adafruit_SSD1608(200, 200, # 1.54" HD mono display
# display = Adafruit_SSD1675(122, 250, # 2.13" HD mono display
# display = Adafruit_SSD1680(122, 250, # 2.13" HD Tri-color display
# display = Adafruit_SSD1681(200, 200, # 1.54" HD Tri-color display
# display = Adafruit_IL91874(176, 264, # 2.7" Tri-color display
# display = Adafruit_IL0373(152, 152, # 1.54" Tri-color display
# display = Adafruit_IL0373(128, 296, # 2.9" Tri-color display
# display = Adafruit_IL0398(400, 300, # 4.2" Tri-color display
display = Adafruit_IL0373(
    104,
    212, # 2.13" Tri-color display
    spi,
    cs_pin=ecs,
    dc_pin=dc,
    sramcs_pin=srcs,
    rst_pin=rst,
    busy_pin=busy,
)

# IF YOU HAVE A FLEXIBLE DISPLAY (2.13" or 2.9") uncomment these lines!
# display.set_black_buffer(1, False)
# display.set_color_buffer(1, False)
```

```

display.rotation = 0

FILENAME = "blinka.bmp"

def read_le(s):
    # as of this writing, int.from_bytes does not have LE support, DIY!
    result = 0
    shift = 0
    for byte in bytearray(s):
        result += byte << shift
        shift += 8
    return result

class BMPError(Exception):
    pass

def display_bitmap(epd, filename): # pylint: disable=too-many-locals, too-many-branches
    try:
        f = open(filename, "rb")
    except OSError:
        print("Couldn't open file")
        return

    print("File opened")
    try:
        if f.read(2) != b"BM": # check signature
            raise BMPError("Not BitMap file")

        bmpFileSize = read_le(f.read(4))
        f.read(4) # Read & ignore creator bytes

        bmpImageoffset = read_le(f.read(4)) # Start of image data
        headerSize = read_le(f.read(4))
        bmpWidth = read_le(f.read(4))
        bmpHeight = read_le(f.read(4))
        flip = True

        print(
            "Size: %d\nImage offset: %d\nHeader size: %d"
            % (bmpFileSize, bmpImageoffset, headerSize)
        )
        print("Width: %d\nHeight: %d" % (bmpWidth, bmpHeight))

        if read_le(f.read(2)) != 1:
            raise BMPError("Not singleplane")
        bmpDepth = read_le(f.read(2)) # bits per pixel
        print("Bit depth: %d" % (bmpDepth))
        if bmpDepth != 24:
            raise BMPError("Not 24-bit")
        if read_le(f.read(2)) != 0:
            raise BMPError("Compressed file")

        print("Image OK! Drawing...")

        rowSize = (bmpWidth * 3 + 3) & ~3 # 32 bit line boundary

```

```

rowSize = (bmpWidth * 3 + 3) & ~3 # 32-bit line boundary

for row in range(bmpHeight): # For each scanline...
    if flip: # Bitmap is stored bottom-to-top order (normal BMP)
        pos = bmpImageoffset + (bmpHeight - 1 - row) * rowSize
    else: # Bitmap is stored top-to-bottom
        pos = bmpImageoffset + row * rowSize

    # print ("seek to %d" % pos)
    f.seek(pos)
    rowdata = f.read(3 * bmpWidth)
    for col in range(bmpWidth):
        b, g, r = rowdata[3 * col : 3 * col + 3] # BMP files store RGB in BGR
        if r < 0x80 and g < 0x80 and b < 0x80:
            epd.pixel(col, row, Adafruit_EPD.BLACK)
        elif r >= 0x80 and g >= 0x80 and b >= 0x80:
            pass # epd.pixel(row, col, Adafruit_EPD.WHITE)
        elif r >= 0x80:
            epd.pixel(col, row, Adafruit_EPD.RED)
    except OSError:
        print("Couldn't read file")
    except BMPError as e:
        print("Failed to parse BMP: " + e.args[0])
    finally:
        f.close()
    print("Finished drawing")

# clear the buffer
display.fill(Adafruit_EPD.WHITE)
display_bitmap(display, FILENAME)
display.display()

```

Before running it, we need to change a few pin definitions though. Find the section of code that looks like this:

```

ecs = digitalio.DigitalInOut(board.D10)
dc = digitalio.DigitalInOut(board.D9)
srcs = digitalio.DigitalInOut(board.D7) # can be None to use internal memory
rst = digitalio.DigitalInOut(board.D11) # can be None to not use this pin
busy = digitalio.DigitalInOut(board.D12) # can be None to not use this pin

```

Change the pins to the following to match the wiring on the Raspberry Pi:

```

ecs = digitalio.DigitalInOut(board.CE0)
dc = digitalio.DigitalInOut(board.D22)
srcs = None
rst = digitalio.DigitalInOut(board.D27)
busy = digitalio.DigitalInOut(board.D17)

```

Next, find the section that looks like this:

```

# display = Adafruit_SSD1608(200, 200, # 1.54" HD mono display
# display = Adafruit_SSD1675(122, 250, # 2.13" HD mono display
# display = Adafruit_SSD1681(200, 200, # 1.54" HD Tri-color display
# display = Adafruit_IL91874(176, 264, # 2.7" Tri-color display
# display = Adafruit_IL0373(152, 152, # 1.54" Tri-color display
# display = Adafruit_IL0373(128, 296, # 2.9" Tri-color display
# display = Adafruit_IL0398(400, 300, # 4.2" Tri-color display
display = Adafruit_IL0373(
    104,
    212,
    spi, # 2.13" Tri-color display
    cs_pin=ecs,
    dc_pin=dc,
    sramcs_pin=sracs,
    rst_pin=rst,
    busy_pin=busy,
)

```

Comment out these lines:

```

display = Adafruit_IL0373(
    104,
    212, # 2.13" Tri-color display

```

and **uncomment** the line that corresponds with your display.

Next we tell the display the rotation setting we want to use. This can be a value between **0-3**. For the 1.54" displays, a value of **2** seems to work well.

```

display.rotation = 2

```

Now go to the command prompt on your Raspberry Pi and run the script with the following command:

```

python3 epd_bitmap.py

```

After a few seconds, your display should show an image like this:

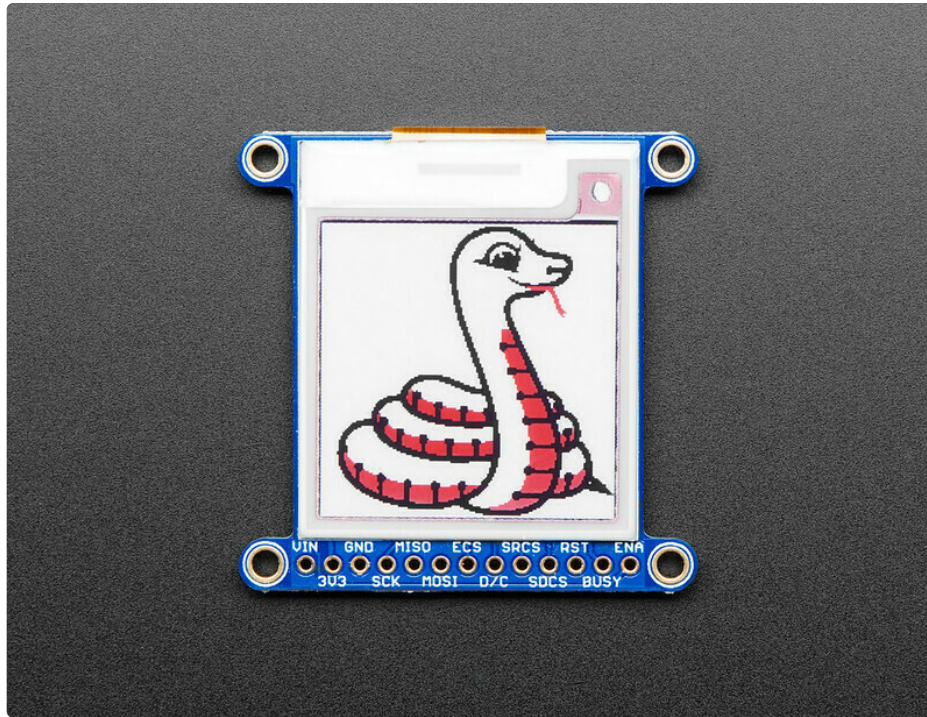

Full Example Code

Here is the full example code.

To run the code sample below, you will need to change the pins the same way as you did in the Tri-color Bitmap Example.

```
# SPDX-FileCopyrightText: 2021 ladyada for Adafruit Industries
# SPDX-License-Identifier: MIT

import digitalio
import busio
import board
from adafruit_epd.epd import Adafruit_EPD
from adafruit_epd.il0373 import Adafruit_IL0373
from adafruit_epd.il91874 import Adafruit_IL91874 # pylint: disable=unused-import
from adafruit_epd.il0398 import Adafruit_IL0398 # pylint: disable=unused-import
from adafruit_epd.ssd1608 import Adafruit_SSD1608 # pylint: disable=unused-import
from adafruit_epd.ssd1675 import Adafruit_SSD1675 # pylint: disable=unused-import
from adafruit_epd.ssd1680 import Adafruit_SSD1680 # pylint: disable=unused-import
from adafruit_epd.ssd1681 import Adafruit_SSD1681 # pylint: disable=unused-import

# create the spi device and pins we will need
spi = busio.SPI(board.SCK, MOSI=board.MOSI, MISO=board.MISO)
ecs = digitalio.DigitalInOut(board.D12)
dc = digitalio.DigitalInOut(board.D11)
srcs = digitalio.DigitalInOut(board.D10) # can be None to use internal memory
rst = digitalio.DigitalInOut(board.D9) # can be None to not use this pin
busv = digitalio.DigitalInOut(board.D5) # can be None to not use this pin
```

```
... digitalWrite(cs_pin, LOW); // can be here to not use this pin
```

```
# give them all to our drivers
print("Creating display")
# display = Adafruit_SSD1608(200, 200,           # 1.54" HD mono display
# display = Adafruit_SSD1675(122, 250,         # 2.13" HD mono display
# display = Adafruit_SSD1680(122, 250,         # 2.13" HD Tri-color display
# display = Adafruit_SSD1681(200, 200,         # 1.54" HD Tri-color display
# display = Adafruit_IL91874(176, 264,        # 2.7" Tri-color display
# display = Adafruit_IL0373(152, 152,         # 1.54" Tri-color display
# display = Adafruit_IL0373(128, 296,        # 2.9" Tri-color display
# display = Adafruit_IL0398(400, 300,         # 4.2" Tri-color display
display = Adafruit_IL0373(
    104,
    212, # 2.13" Tri-color display
    spi,
    cs_pin=ecs,
    dc_pin=dc,
    sramcs_pin=srscs,
    rst_pin=rst,
    busy_pin=busy,
)

# IF YOU HAVE A FLEXIBLE DISPLAY (2.13" or 2.9") uncomment these lines!
# display.set_black_buffer(1, False)
# display.set_color_buffer(1, False)

display.rotation = 1

# clear the buffer
print("Clear buffer")
display.fill(Adafruit_EPDM_BLACK)
display.pixel(10, 100, Adafruit_EPDM_BLACK)

print("Draw Rectangles")
display.fill_rect(5, 5, 10, 10, Adafruit_EPDM_RED)
display.rect(0, 0, 20, 30, Adafruit_EPDM_BLACK)

print("Draw lines")
display.line(0, 0, display.width - 1, display.height - 1, Adafruit_EPDM_BLACK)
display.line(0, display.height - 1, display.width - 1, 0, Adafruit_EPDM_RED)

print("Draw text")
display.text("hello world", 25, 10, Adafruit_EPDM_BLACK)
display.display()
```

Image Drawing with Pillow

In this image, we will use Pillow to resize and crop the image automatically and draw it the the ePaper Display. Pillow is really powerful and with it you can open and render additional file formats such as PNG or JPG. Let's start with downloading a PNG of blinka that has been adjusted down to 3 colors so it prints nicely on an ePaper Display. We are using PNG for this because it is a lossless format and won't introduce unexpected colors in.

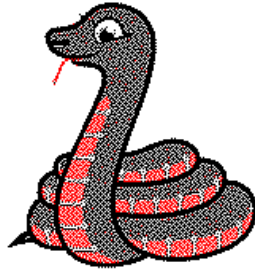

Make sure you save it as **blinka.png** and place it in the same folder as your script. Here's the code we'll be loading onto the Raspberry Pi. Go ahead and copy it onto your Raspberry Pi and save it as **epd_pillow_image.py**. We'll go over the interesting parts.

```
# SPDX-FileCopyrightText: 2019 Melissa LeBlanc-Williams for Adafruit Industries
# SPDX-License-Identifier: MIT

"""
Image resizing and drawing using the Pillow Library. For the image, check out the
associated Adafruit Learn guide at:
https://learn.adafruit.com/adafruit-eink-display-breakouts/python-code
"""

import digitalio
import busio
import board
from PIL import Image
from adafruit_epd.il0373 import Adafruit_IL0373
from adafruit_epd.il91874 import Adafruit_IL91874 # pylint: disable=unused-import
from adafruit_epd.il0398 import Adafruit_IL0398 # pylint: disable=unused-import
from adafruit_epd.ssd1608 import Adafruit_SSD1608 # pylint: disable=unused-import
from adafruit_epd.ssd1675 import Adafruit_SSD1675 # pylint: disable=unused-import
from adafruit_epd.ssd1680 import Adafruit_SSD1680 # pylint: disable=unused-import
from adafruit_epd.ssd1681 import Adafruit_SSD1681 # pylint: disable=unused-import

# create the spi device and pins we will need
spi = busio.SPI(board.SCK, MOSI=board.MOSI, MISO=board.MISO)
ecs = digitalio.DigitalInOut(board.CE0)
dc = digitalio.DigitalInOut(board.D22)
srcs = None
rst = digitalio.DigitalInOut(board.D27)
busy = digitalio.DigitalInOut(board.D17)

# give them all to our driver
# display = Adafruit_SSD1608(200, 200, # 1.54" HD mono display
# display = Adafruit_SSD1675(122, 250, # 2.13" HD mono display
# display = Adafruit_SSD1680(122, 250, # 2.13" HD Tri-color or mono display
# display = Adafruit_SSD1681(122, 250, # 2.13" HD Tri-color or mono display
```



```

# display = Adafruit_SSD1681(200, 200, # 1.54" HD Tri-color display
# display = Adafruit_IL91874(176, 264, # 2.7" Tri-color display
# display = Adafruit_IL0373(152, 152, # 1.54" Tri-color display
# display = Adafruit_IL0373(128, 296, # 2.9" Tri-color display
# display = Adafruit_IL0398(400, 300, # 4.2" Tri-color display
display = Adafruit_IL0373(
    104,
    212, # 2.13" Tri-color display
    spi,
    cs_pin=ecs,
    dc_pin=dc,
    sramcs_pin=srcs,
    rst_pin=rst,
    busy_pin=busy,
)

# IF YOU HAVE A FLEXIBLE DISPLAY (2.13" or 2.9") uncomment these lines!
# display.set_black_buffer(1, False)
# display.set_color_buffer(1, False)

display.rotation = 1

image = Image.open("blinka.png")

# Scale the image to the smaller screen dimension
image_ratio = image.width / image.height
screen_ratio = display.width / display.height
if screen_ratio < image_ratio:
    scaled_width = image.width * display.height // image.height
    scaled_height = display.height
else:
    scaled_width = display.width
    scaled_height = image.height * display.width // image.width
image = image.resize((scaled_width, scaled_height), Image.BICUBIC)

# Crop and center the image
x = scaled_width // 2 - display.width // 2
y = scaled_height // 2 - display.height // 2
image = image.crop((x, y, x + display.width, y + display.height)).convert("RGB")

# Convert to Monochrome and Add dithering
# image = image.convert("1").convert("L")

# Display image.
display.image(image)
display.display()

```

So we start with our usual imports including a couple of Pillow modules and the ePaper display drivers.

```

import digitalio
import busio
import board
from PIL import Image, ImageDraw
from adafruit_epd.il0373 import Adafruit_IL0373
from adafruit_epd.il91874 import Adafruit_IL91874
from adafruit_epd.il0398 import Adafruit_IL0398
from adafruit_epd.ssd1608 import Adafruit_SSD1608
from adafruit_epd.ssd1675 import Adafruit_SSD1675
from adafruit_epd.ssd1681 import Adafruit_SSD1681

```

That is followed by initializing the SPI bus and defining a few pins here. The reason we chose these is because they allow you to use the same code with the EPD bonnets if you chose to do so.

```

spi = busio.SPI(board.SCK, MOSI=board.MOSI, MISO=board.MISO)
ecs = digitalio.DigitalInOut(board.CE0)
dc = digitalio.DigitalInOut(board.D22)
srcs = None
rst = digitalio.DigitalInOut(board.D27)
busy = digitalio.DigitalInOut(board.D17)

```

We wanted to make these examples work on as many displays as possible with very few changes. The 2.13" Tri-color display is selected by default. For other displays, go ahead and comment out the following lines:

```

display = Adafruit_IL0373(
    104,
    212, # 2.13" Tri-color display

```

and uncomment the line appropriate for your display.

```

#display = Adafruit_SSD1608(200, 200, # 1.54" HD mono display
#display = Adafruit_SSD1675(122, 250, # 2.13" HD mono display
#display = Adafruit_SSD1681(200, 200, # 1.54" HD Tri-color display
#display = Adafruit_IL91874(176, 264, # 2.7" Tri-color display
#display = Adafruit_IL0373(152, 152, # 1.54" Tri-color display
#display = Adafruit_IL0373(128, 296, # 2.9" Tri-color display
#display = Adafruit_IL0398(400, 300, # 4.2" Tri-color display
display = Adafruit_IL0373(
    104,
    212, # 2.13" Tri-color display
    spi,
    cs_pin=ecs,
    dc_pin=dc,
    sramcs_pin=srcs,
    rst_pin=rst,
    busy_pin=busy
)

```

Next change the rotation setting to `2`.

```
display.rotation = 2
```

Next we open the Blinka image, which we've named **blinka.png**, which assumes it is in the same directory that you are running the script from. Feel free to change it if it doesn't match your configuration.

```
image = Image.open("blinka.png")
```

Here's where it starts to get interesting. We want to scale the image so that it matches either the width or height of the display, depending on which is smaller, so that we have some of the image to chop off when we crop it. So we start by calculating the width to height ration of both the display and the image. If the height is the closer of the dimensions, we want to match the image height to the display height and let it be a bit wider than the display. Otherwise, we want to do the opposite.

Once we've figured out how we're going to scale it, we pass in the new dimensions and using a **Bicubic** rescaling method, we reassign the newly rescaled image back to `image`. Pillow has quite a few different methods to choose from, but Bicubic does a great job and is reasonably fast.

Nearest actually gives a little better result with the Tri-color elinks, but loses detail with displaying a color image on the monochrome display, so we decided to go with the best balance.

```
image_ratio = image.width / image.height
screen_ratio = display.width / display.height
if screen_ratio < image_ratio:
    scaled_width = image.width * display.height // image.height
    scaled_height = display.height
else:
    scaled_width = display.width
    scaled_height = image.height * display.width // image.width
image = image.resize((scaled_width, scaled_height), Image.BICUBIC)
```

Next we want to figure the starting x and y points of the image where we want to begin cropping it so that it ends up centered. We do that by using a standard centering function, which is basically requesting the difference of the center of the display and the center of the image. Just like with scaling, we replace the `image` variable with the newly cropped image.

```
x = scaled_width // 2 - display.width // 2
y = scaled_height // 2 - display.height // 2
image = image.crop((x, y, x + display.width, y + display.height))
```

Finally, we take our `image`, draw it to the frame buffer and `display` it. At this point, the image should have the exact same dimensions at the display and fill it completely.

```
display.image(image)
display.display()
```

Now go to the command prompt on your Raspberry Pi and run the script with the following command:

```
python3 epd_pillow_image.py
```

After a few seconds, your display should show this image:

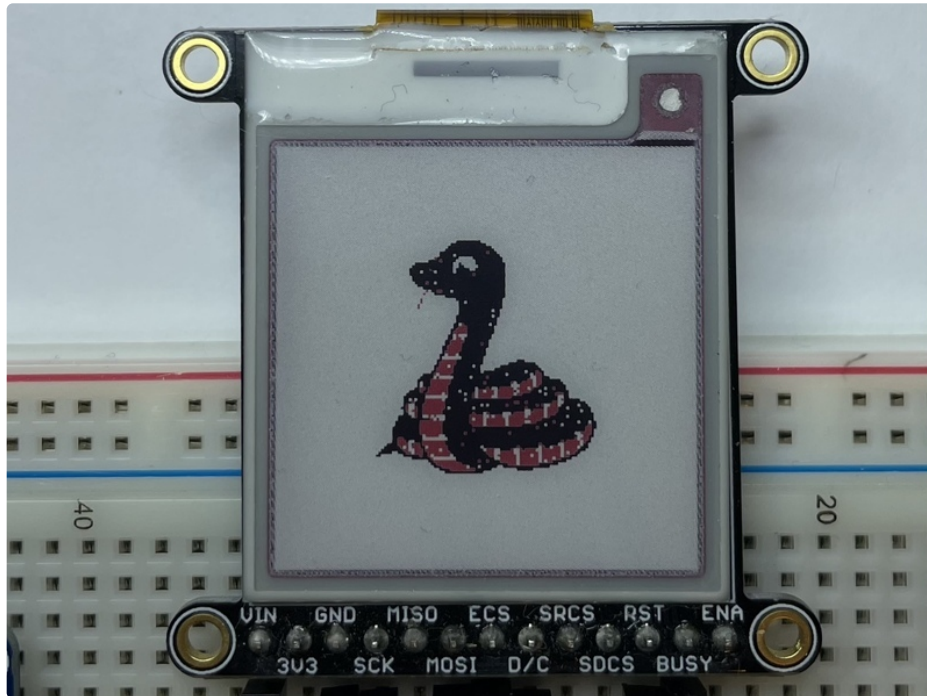

Drawing Shapes and Text with Pillow

In the next example, we'll take a look at drawing shapes and text. This is very similar to the displayio example, but it uses Pillow instead. Go ahead and copy it onto your Raspberry Pi and save it as `epd_pillow_demo.py`. Here's the code for that.

```
# SPDX-FileCopyrightText: 2019 Melissa LeBlanc-Williams for Adafruit Industries
# SPDX-License-Identifier: MIT

"""
ePaper Display Shapes and Text demo using the Pillow Library.
"""

import digitalio
import busio
import board
from PIL import Image, ImageDraw, ImageFont
from adafruit_epd.il0373 import Adafruit_IL0373
from adafruit_epd.il91874 import Adafruit_IL91874 # pylint: disable=unused-import
```

```

from adafruit_epd.il0398 import Adafruit_IL0398 # pylint: disable=unused-import
from adafruit_epd.ssd1608 import Adafruit_SSD1608 # pylint: disable=unused-import
from adafruit_epd.ssd1675 import Adafruit_SSD1675 # pylint: disable=unused-import
from adafruit_epd.ssd1680 import Adafruit_SSD1680 # pylint: disable=unused-import
from adafruit_epd.ssd1681 import Adafruit_SSD1681 # pylint: disable=unused-import

# First define some color constants
WHITE = (0xFF, 0xFF, 0xFF)
BLACK = (0x00, 0x00, 0x00)
RED = (0xFF, 0x00, 0x00)

# Next define some constants to allow easy resizing of shapes and colors
BORDER = 20
FONTSIZE = 24
BACKGROUND_COLOR = BLACK
FOREGROUND_COLOR = WHITE
TEXT_COLOR = RED

# create the spi device and pins we will need
spi = busio.SPI(board.SCK, MOSI=board.MOSI, MISO=board.MISO)
ecs = digitalio.DigitalInOut(board.CE0)
dc = digitalio.DigitalInOut(board.D22)
srcs = None
rst = digitalio.DigitalInOut(board.D27)
busy = digitalio.DigitalInOut(board.D17)

# give them all to our driver
# display = Adafruit_SSD1608(200, 200, # 1.54" HD mono display
# display = Adafruit_SSD1675(122, 250, # 2.13" HD mono display
# display = Adafruit_SSD1680(122, 250, # 2.13" HD Tri-color or mono display
# display = Adafruit_SSD1681(200, 200, # 1.54" HD Tri-color display
# display = Adafruit_IL91874(176, 264, # 2.7" Tri-color display
# display = Adafruit_IL0373(152, 152, # 1.54" Tri-color display
# display = Adafruit_IL0373(128, 296, # 2.9" Tri-color display
# display = Adafruit_IL0398(400, 300, # 4.2" Tri-color display
display = Adafruit_IL0373(
    104,
    212, # 2.13" Tri-color display
    spi,
    cs_pin=ecs,
    dc_pin=dc,
    sramcs_pin=srcs,
    rst_pin=rst,
    busy_pin=busy,
)

# IF YOU HAVE A FLEXIBLE DISPLAY (2.13" or 2.9") uncomment these lines!
# display.set_black_buffer(1, False)
# display.set_color_buffer(1, False)

display.rotation = 1

image = Image.new("RGB", (display.width, display.height))

# Get drawing object to draw on image.
draw = ImageDraw.Draw(image)

```

```

# Draw a filled box as the background
draw.rectangle((0, 0, display.width - 1, display.height - 1), fill=BACKGROUND_COLOR)

# Draw a smaller inner foreground rectangle
draw.rectangle(
    (BORDER, BORDER, display.width - BORDER - 1, display.height - BORDER - 1),
    fill=FOREGROUND_COLOR,
)

# Load a TTF Font
font = ImageFont.truetype("/usr/share/fonts/truetype/dejavu/DejaVuSans.ttf", FONTSIZE)

# Draw Some Text
text = "Hello World!"
(font_width, font_height) = font.getsize(text)
draw.text(
    (display.width // 2 - font_width // 2, display.height // 2 - font_height // 2),
    text,
    font=font,
    fill=TEXT_COLOR,
)

# Display image.
display.image(image)
display.display()

```

Just like in the last example, we'll do our imports, but this time we're including the `ImageDraw` and `ImageFont` Pillow modules because we'll be drawing some text this time.

```

import digitalio
import busio
import board
from PIL import Image, ImageDraw, ImageFont
from adafruit_epd.il0373 import Adafruit_IL0373
from adafruit_epd.il91874 import Adafruit_IL91874
from adafruit_epd.il0398 import Adafruit_IL0398
from adafruit_epd.ssd1608 import Adafruit_SSD1608
from adafruit_epd.ssd1675 import Adafruit_SSD1675
from adafruit_epd.ssd1681 import Adafruit_SSD1681

```

Next we define some colors that can be used with Pillow.

```

WHITE = (0xFF, 0xFF, 0xFF)
BLACK = (0x00, 0x00, 0x00)
RED = (0xFF, 0x00, 0x00)

```

After that, we create some parameters that are easy to change. If you had a smaller display for instance, you could reduce the `FONTSIZE` and `BORDER` parameters. The `BORDER` will be the size in pixels of the green border between the edge of the display and the inner purple rectangle. The `FONTSIZE` will be the size of the font in points so that we can adjust it easily for different displays. You could play around with

the colors as well. One thing to note is that on monochrome displays, the `RED` will show up as `BLACK`.

For the 1.54" display, a `BORDER` value of `10` and a `FONTSIZE` value of `20` looks good.

```
BORDER = 10
FONTSIZE = 20
BACKGROUND_COLOR = BLACK
FOREGROUND_COLOR = WHITE
TEXT_COLOR = RED
```

After that, the initializer and rotation sections are exactly the same as in the previous example. **If you have are using a different display than the 2.13" Tri-color, go ahead and adjust your initializer as explained in the previous example.** After that, we will create an `image` with our dimensions and use that to create a `draw` object. The `draw` object will have all of our drawing functions.

```
image = Image.new('RGB', (display.width, display.height))
draw = ImageDraw.Draw(image)
```

Next we clear whatever is on the screen by drawing a rectangle using the `BACKGROUND_COLOR` that takes up the full screen.

```
draw.rectangle((0, 0, display.width, display.height), fill=BACKGROUND_COLOR)
```

Next we will draw an inner rectangle using the `FOREGROUND_COLOR`. We use the `BORDER` parameter to calculate the size and position that we want to draw the rectangle.

```
draw.rectangle((BORDER, BORDER, display.width - BORDER - 1, display.height - BORDER - 1),
               fill=FOREGROUND_COLOR)
```

Next we'll load a TTF font. The `DejaVuSans.ttf` font should come preloaded on your Pi in the location in the code. We also make use of the `FONTSIZE` parameter that we discussed earlier.

```
font = ImageFont.truetype('/usr/share/fonts/truetype/dejavu/DejaVuSans.ttf', FONTSIZE)
```

Now we draw the text Hello World onto the center of the display. You may recognize the centering calculation was the same one we used to center crop the image in the previous example. In this example though, we get the font size values using the `getsize()` function of the font object.

```
text = "Hello World!"
(font_width, font_height) = font.getsize(text)
draw.text((display.width//2 - font_width//2, display.height//2 - font_height//2),
          text, font=font, fill=TEXT_COLOR)
```

Finally, just like before, we display the image.

```
display.image(image)
display.display()
```

Now go to the command prompt on your Raspberry Pi and run the script with the following command:

```
python3 epd_pillow_demo.py
```

After a few seconds, your display should show this image:



Downloads

Files

- [Fritzing object in Adafruit Fritzing Library \(https://adafru.it/aP3\)](https://adafru.it/aP3)
- [IL0376F E-Ink interface chip datasheet \(https://adafru.it/BRW\)](https://adafru.it/BRW)
- [SSD1608 E-Ink interface chip datasheet \(https://adafru.it/QC5\)](https://adafru.it/QC5)
- [SSD1681 Datasheet \(https://adafru.it/QC6\)](https://adafru.it/QC6)
- [PCB Files on GitHub \(https://adafru.it/BRX\)](https://adafru.it/BRX)

Display shape/outline:

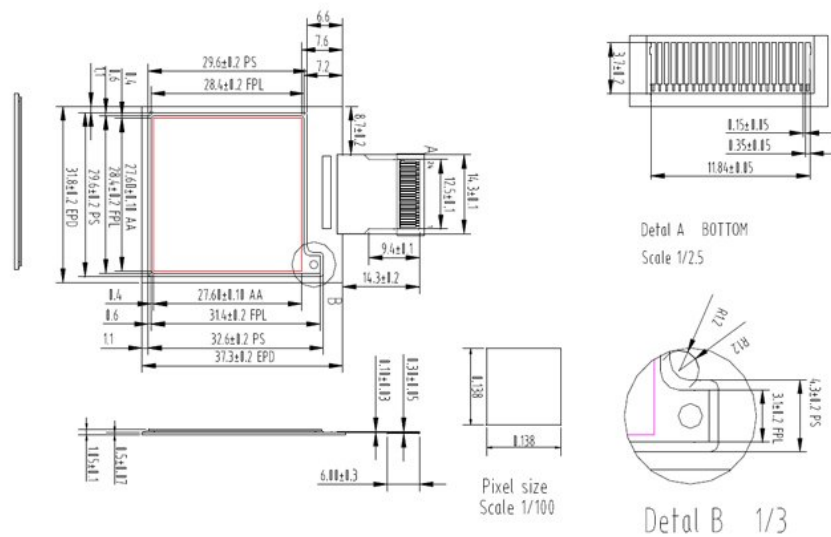

Schematic

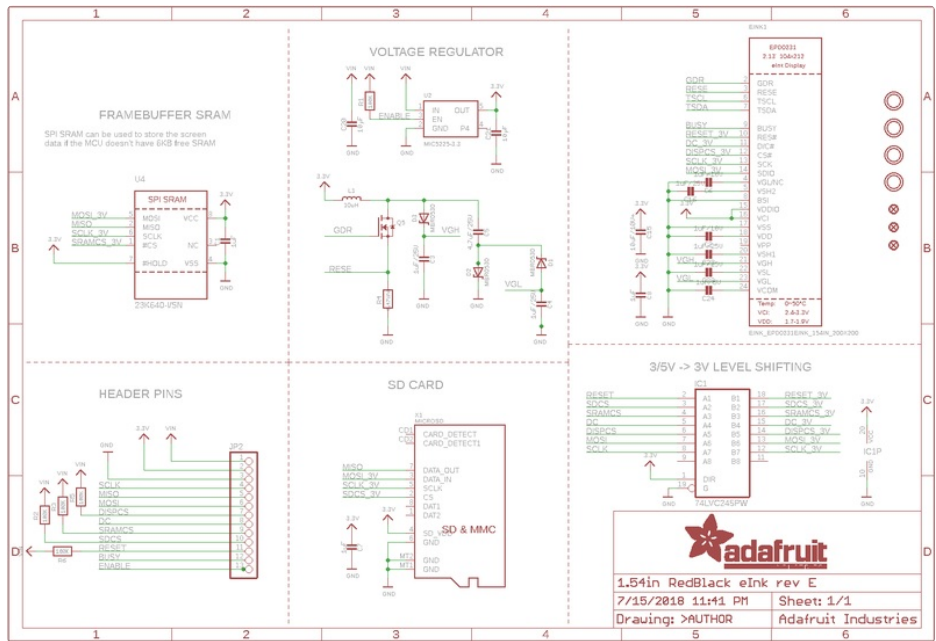

Fabrication Print

