

ALS30M683NT100

Aliases (A331TW683M100M)

Obsolete

ALS30, Aluminum Electrolytic, 68,000 uF, 20%, 100 VDC, -40/+85°C

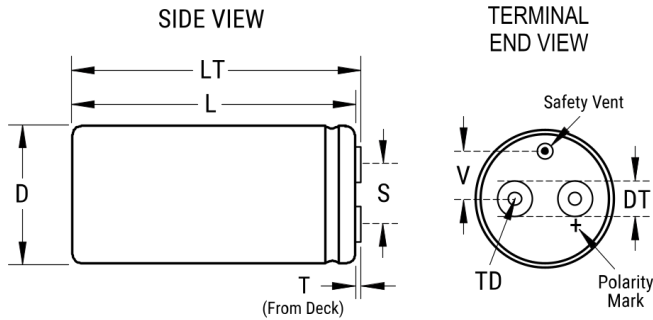

General Information

Series	ALS30
Dielectric	Aluminum Electrolytic
Description	Screw Terminal, Aluminum Electrolytic
RoHS	Yes
AEC-Q200	No
Component Weight	1450 g
Notes	Dimensions D And L Include Sleevings. Dimension LT Available On Request. MS (MxH) = M12x16. Mounting Clamp (Sold Separately): V11
Shelf Life	156 Weeks

Specifications

Capacitance	68,000 uF
Capacitance Tolerance	20%
Voltage DC	100 VDC, 115 VDC (Surge)
Temperature Range	-40/+85°C
Rated Temperature	85°C
Life	20000 Hrs (Rated Voltage And Ripple Current At 85C), 40000 Hrs (Rated Voltage At 85C)
Resistance	7 mOhms (100Hz 20C), 6 mOhms (10kHz 20C)
Ripple Current	40.6 Amps (100Hz 85C), 41.5 Amps (10kHz 85C)
Leakage Current	6000 uA (5min 20°C)

Dimensions

D	77mm +/-1mm
L	220mm +/-2mm
T	7.14mm +/-0.5mm
S	31.8mm +/-0.5mm
DT	8mm +/-0.5mm
LT	224.5mm +/-1mm
TD	10mm MIN
V	19mm NOM

Packaging Specifications

Sleevings	Yes
Packaging	Bulk, Box

Statements of suitability for certain applications are based on our knowledge of typical operating conditions for such applications, but are not intended to constitute - and we specifically disclaim - any warranty concerning suitability for a specific customer application or use. This information is intended for use only by customers who have the requisite experience and capability to determine the correct products for their application. Any technical advice inferred from this information or otherwise provided by us with reference to the use of our products is given gratis, and we assume no obligation or liability for the advice given or results obtained.