

200 Watt - LD200W Series

CONSTANT VOLTAGE OR CONSTANT CURRENT LED DRIVER WITH DIMMING



200W
LD200W Series
DIMMING

Model: LD200W Series

- Drive Mode: Constant Current or Constant Voltage
- Technology: PFC Corrected 2-Stage Switch Mode
- Output Power: 200W Max.
- Input Voltage: 90 to 305VAC, 47- 63Hz
- Number of Outputs: One
- Output Voltages: 8VDC - 445VDC
- Output Currents: 450mA - 8330mA
- Optional 0-10V or PWM Positive Dimming 10% ~ 100%

Environmental

1. Operating temperature: Tc 90C Maximum. Reference -30 to +60°C ambient
2. For UL Type TL Recognized Versions: (Tref Max/Meas. Tref): 90/82°C
3. Storage temperature range: -40 to +85°C
4. Humidity (non-condensing): 5% - 95%RH
5. Cooling: Convection
6. Vibration Frequency: 5-55Hz/2g, 30 minutes
7. Impact resistance: 1g/s
8. MTBF@ 40°C: 280,000 hours @ Full Load per MIL-217F Notice 2.

Safety and Compliance

1. Class P: UL8750, EN61347, CSA 22.2 safety listed, UL Class P -or- Type TL: UL8750, EN61347, CSA 22.2, UL TL recognized
2. FCC, 47CFR Part 15 Class B certified
3. Water resistant and Dust Proof Design: IP66, NEMA6, for Dry, Damp, Wet Locations.
4. Compact Miniature, Lightweight Design.
5. Safety Isolation between Primary and Secondary
6. Meets EN61000-3-2 & EN61000-3-3 Class C
7. Protection: output over-voltage, output over-current, output short circuit, auto-recovery.
8. EN61000-4-5: 2kV/4kV 8/20 μsec surge protection.

Electrical Specifications at 25°C

- Input voltage range: 90 to 305VAC
- Frequency: 47- 63Hz
- Power Factor: ≥ 0.90 at $\geq 60\%$ Load, 120Vac/230Vac/277Vac 50/60Hz
- THD%: $\leq 20\%$ at $\geq 60\%$ Load, 120Vac/230Vac/277Vac 50/60Hz
- Inrush current: $<60A$ at 25C, 277Vac, cold start, Full Load
- Input current: 0.96A Max @ 230Vac, 1.82A Max @ 120Vac, Full Load
- Efficiency: Up to 92% typical at 230Vac Full Load
- Line regulation accuracy: $\pm 3\%$
- Load regulation accuracy: $\pm 4\%$
- Leakage current: 277Vac, 700uA typical; Hold up time: half cycle

Mechanical Dimensions: Inches [mm]

Material: Black Aluminum Housing
Fully Encapsulated
Weight: 940 grams (33.2 oz) Typical

Labeling Example

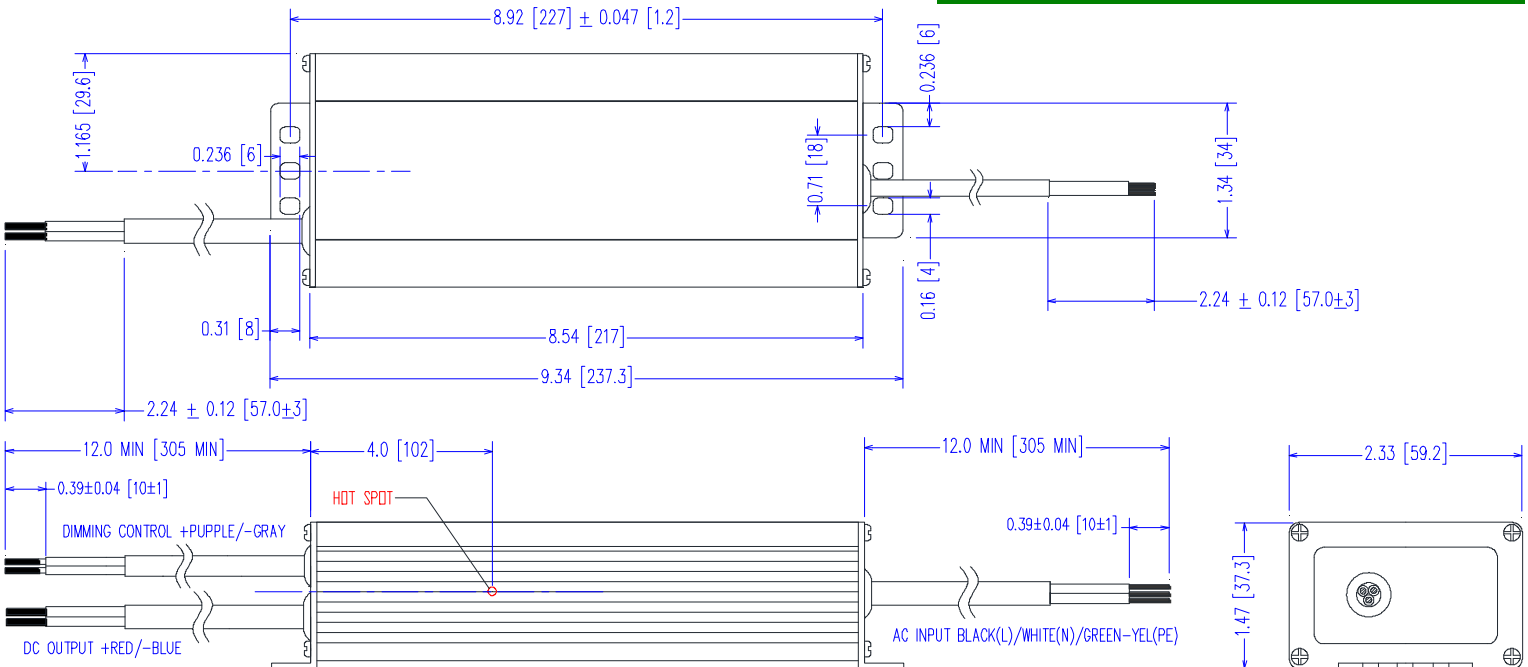
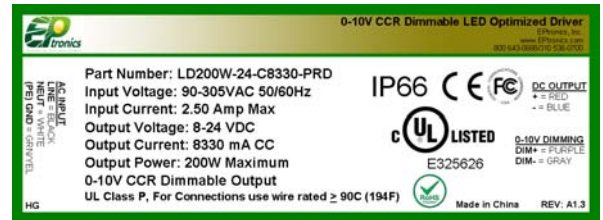

200 Watt - LD200W Series

CONSTANT VOLTAGE OR CONSTANT CURRENT LED DRIVER WITH DIMMING

UL Class P Constant Current Versions

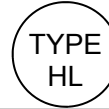

IP66



Part Number ⁽²⁾	UL Types	Output Voltage Range	Output Constant Current	Current Accuracy	Output Power Maximum	Typical Efficiency ⁽¹⁾
LD200W-445-C0450-P	HL	149 - 445 VDC	450 mA	± 5%	200W	92%
LD200W-285-C0700-P	HL	95 - 285 VDC	700 mA	± 5%	200W	92%
LD200W-190-C1050-P	HL	64 - 190 VDC	1050 mA	± 5%	200W	91%
LD200W-142-C1400-P	HL	48 - 142 VDC	1400 mA	± 5%	200W	91%
LD200W-114-C1750-P	HL	38 - 114 VDC	1750 mA	± 5%	200W	91%
LD200W-95-C2100-P	HL	32 - 95 VDC	2100 mA	± 5%	200W	91%
LD200W-81-C2450-P	HL	27 - 81 VDC	2450 mA	± 5%	200W	90%
LD200W-71-C2800-P	HL	24 - 71 VDC	2800 mA	± 5%	200W	90%
LD200W-63-C3150-P	HL	21 - 63 VDC	3150 mA	± 5%	200W	90%
LD200W-57-C3500-P	HL	19 - 57 VDC	3500 mA	± 5%	200W	90%
LD200W-47-C4200-P	HL	16 - 47 VDC	4200 mA	± 5%	200W	89%
LD200W-40-C4900-P	HL	14 - 40 VDC	4900 mA	± 5%	200W	89%
LD200W-35-C5600-P	HL	12 - 35 VDC	5600 mA	± 5%	200W	89%
LD200W-32-C6300-P	HL	11 - 32 VDC	6300 mA	± 5%	200W	88%
LD200W-24-C8330-P ⁽⁵⁾	HL	8 - 24 VDC	8330 mA	± 5%	200W	88%

UL Class P Constant Voltage Versions

Part Number	UL Types	Output Constant Voltage	Output Current Range	Voltage Accuracy	Output Power Maximum	Typical Efficiency ⁽¹⁾
LD200W-445-P	HL	445 VDC	113 - 450 mA	± 5%	200W	92%
LD200W-285-P	HL	285 VDC	175 - 700 mA	± 5%	200W	92%
LD200W-190-P	HL	190 VDC	263 - 1050 mA	± 5%	200W	91%
LD200W-142-P	HL	142 VDC	350 - 1400 mA	± 5%	200W	91%
LD200W-114-P	HL	114 VDC	438 - 1750 mA	± 5%	200W	91%
LD200W-95-P	HL	95 VDC	525 - 2100 mA	± 5%	200W	91%
LD200W-81-P	HL	81 VDC	613 - 2450 mA	± 5%	200W	90%
LD200W-71-P	HL	71 VDC	700 - 2800 mA	± 5%	200W	90%
LD200W-63-P	HL	63 VDC	788 - 3150 mA	± 5%	200W	90%
LD200W-57-P	HL	57 VDC	875 - 3500 mA	± 5%	200W	90%
LD200W-47-P	HL	47 VDC	1050 - 4200 mA	± 5%	200W	89%
LD200W-40-P	HL	40 VDC	1225 - 4900 mA	± 5%	200W	89%
LD200W-35-P	HL	35 VDC	1400 - 5600 mA	± 5%	200W	89%
LD200W-32-P	HL	32 VDC	1575 - 6300 mA	± 5%	200W	88%
LD200W-24-P ⁽⁵⁾	HL	24 VDC	2083 - 8330 mA	± 5%	200W	88%

Notes

1. Typical efficiency measured at 230VAC input, full load
2. For dimmable versions add appropriate designator to the end of the part number: For Example: LD200W-24-C8330-PRD is 0-10V dimmable version, LD200W-24-C8330-PPD is PWM dimmable version.
-PRD 0-10V & Resistance dimmable version comes with an extra two wires +Purple/-Grey on the output side.
-PPD PWM Dimmable version comes with an extra two wires +Purple/-Grey on the output side.
3. -PRD 0-10V Dimming is compatible with most quality 0-10V wall dimmers and direct 0-10V analog signal. See page 4 for details.
4. -PPD PWM version is PWM Dimmable via a positive 10% to 100% Duty Cycle, 500Hz to 1.5kHz, 0-10V Pulse. See page 5 for details.
5. SAM Recognized under E325626.



LED Optimized Drivers

200 Watt - LD200W Series

CONSTANT VOLTAGE OR CONSTANT CURRENT LED DRIVER WITH DIMMING

200W
 LD200W Series
 DIMMING

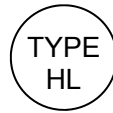
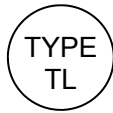

IP66



TYPE TL Constant Current Versions

Part Number ⁽²⁾	UL Types	Output Voltage Range	Output Constant Current	Current Accuracy	Output Power Maximum	Typical Efficiency ⁽¹⁾
LD200W-445-C0450	TL & HL	149 - 445 VDC	450 mA	± 5%	200W	92%
LD200W-285-C0700	TL & HL	95 - 285 VDC	700 mA	± 5%	200W	92%
LD200W-190-C1050	TL & HL	64 - 190 VDC	1050 mA	± 5%	200W	91%
LD200W-142-C1400	TL & HL	48 - 142 VDC	1400 mA	± 5%	200W	91%
LD200W-114-C1750	TL & HL	38 - 114 VDC	1750 mA	± 5%	200W	91%
LD200W-95-C2100	TL & HL	32 - 95 VDC	2100 mA	± 5%	200W	91%
LD200W-81-C2450	TL & HL	27 - 81 VDC	2450 mA	± 5%	200W	90%
LD200W-71-C2800	TL & HL	24 - 71 VDC	2800 mA	± 5%	200W	90%
LD200W-63-C3150	TL & HL	21 - 63 VDC	3150 mA	± 5%	200W	90%
LD200W-57-C3500	TL & HL	19 - 57 VDC	3500 mA	± 5%	200W	90%
LD200W-47-C4200	TL & HL	16 - 47 VDC	4200 mA	± 5%	200W	89%
LD200W-40-C4900	TL & HL	14 - 40 VDC	4900 mA	± 5%	200W	89%
LD200W-35-C5600	TL & HL	12 - 35 VDC	5600 mA	± 5%	200W	89%
LD200W-32-C6300	TL & HL	11 - 32 VDC	6300 mA	± 5%	200W	88%
LD200W-24-C8330 ⁽⁵⁾	TL & HL	8 - 24 VDC	8330 mA	± 5%	200W	88%

TYPE TL Constant Voltage Versions

Part Number	UL Types	Output Constant Voltage	Output Current Range	Voltage Accuracy	Output Power Maximum	Typical Efficiency ⁽¹⁾
LD200W-445	TL & HL	445 VDC	113 - 450 mA	± 5%	200W	92%
LD200W-285	TL & HL	285 VDC	175 - 700 mA	± 5%	200W	92%
LD200W-190	TL & HL	190 VDC	263 - 1050 mA	± 5%	200W	91%
LD200W-142	TL & HL	142 VDC	350 - 1400 mA	± 5%	200W	91%
LD200W-114	TL & HL	114 VDC	438 - 1750 mA	± 5%	200W	91%
LD200W-95	TL & HL	95 VDC	525 - 2100 mA	± 5%	200W	91%
LD200W-81	TL & HL	81 VDC	613 - 2450 mA	± 5%	200W	90%
LD200W-71	TL & HL	71 VDC	700 - 2800 mA	± 5%	200W	90%
LD200W-63	TL & HL	63 VDC	788 - 3150 mA	± 5%	200W	90%
LD200W-57	TL & HL	57 VDC	875 - 3500 mA	± 5%	200W	90%
LD200W-47	TL & HL	47 VDC	1050 - 4200 mA	± 5%	200W	89%
LD200W-40	TL & HL	40 VDC	1225 - 4900 mA	± 5%	200W	89%
LD200W-35	TL & HL	35 VDC	1400 - 5600 mA	± 5%	200W	89%
LD200W-32	TL & HL	32 VDC	1575 - 6300 mA	± 5%	200W	88%
LD200W-24 ⁽⁵⁾	TL & HL	24 VDC	2083 - 8330 mA	± 5%	200W	88%

Notes

1. Typical efficiency measured at 230VAC input, full load
2. For dimmable versions add appropriate designator to the end of the part number: For Example: LD200W-24-C8330-RD is 0-10V or resistance dimmable version, LD200W-24-C8330-PD is PWM dimmable version.
 -RD 0-10V & Resistance dimmable version comes with an extra two wires +Purple/-Grey on the output side.
 -PD PWM Dimmable version comes with an extra two wires +Purple/-Grey on the output side.
3. -RD 0-10V Dimming is compatible with most quality 0-10V wall dimmers and direct 0-10V analog signal. See page 4 for details.
4. -PD PWM version is PWM Dimmable via a positive 10% to 100% Duty Cycle, 500Hz to 1.5kHz, 0-10V Pulse. See page 5 for details.
5. SAM Recognized under E325626.

Custom designs available. Please consult with the factory.

Specifications subject to change without notice

200 Watt - LD200W Series

CONSTANT VOLTAGE OR CONSTANT CURRENT LED DRIVER WITH DIMMING

-RD 2-Wire 0-10V CCR Dimming Scheme

Parameters	Minimum	Typical	Maximum
Source Current out of 0-10V Purple Wire	0mA	—	2mA
Absolute Voltage Range on 0-10V (+) Purple Wire	-2.0V	—	+15V
Sink Current into 0-10V Purple Wire	0mA	—	1.2mA

Notes

1. -RD 0-10V dimmable version comes with an extra two wires +Purple/-Grey on the output side.
2. -RD version is compatible with most 0-10V Wall Slide dimmers and direct 0-10V analog signal.
Recommended wall slide dimmer is Leviton IP710 or equivalent
3. -RD 0-10V dimmable version is not intended to dim below about 5% @ 0V or 10% @ 1.0V
4. -RD 0-10V dimmable version output will be 100% with Purple/Grey open and minimum with Purple/Grey Shorted.

-RD 2-Wire Resistance Dimming Scheme

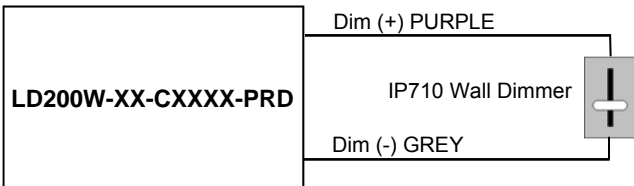

-RD 2-Wire 0-10V Analog Dimming Scheme

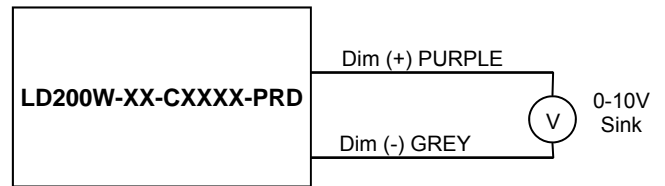

% Output Current vs. 0-10VDC Dimming Input

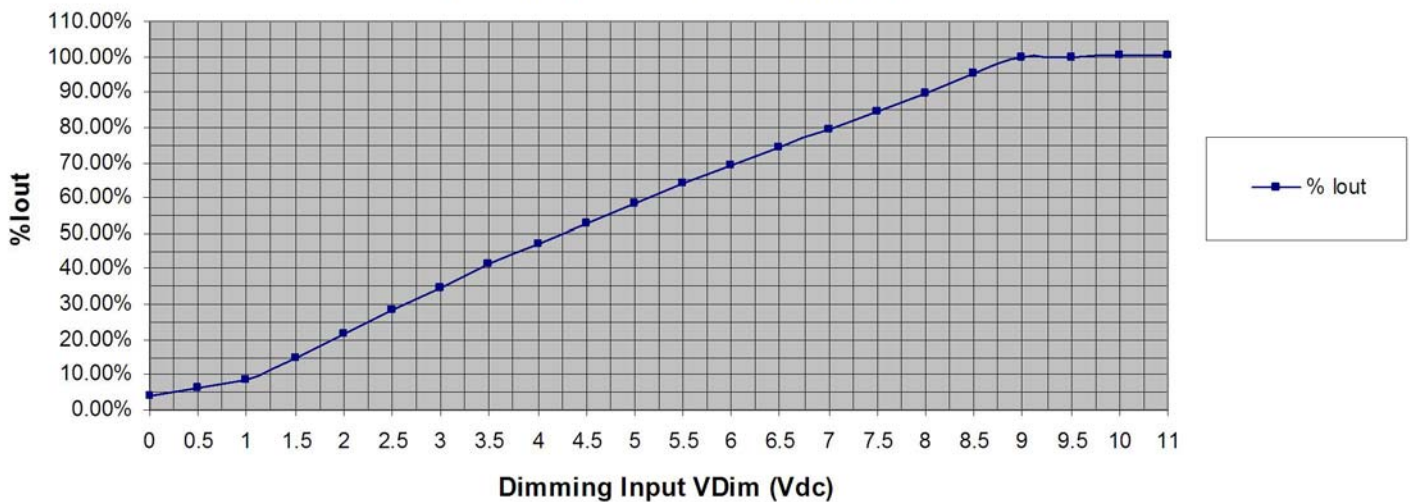

200 Watt - LD200W Series

CONSTANT VOLTAGE OR CONSTANT CURRENT LED DRIVER WITH DIMMING

200W
 LD200W Series
 DIMMING

-PD 2-Wire CCR PWM Positive Dimming Scheme

Parameters	Minimum	Typical	Maximum
Absolute Maximum Voltage Range on PWM Input (Purple Wire)	-2.0V	10V	+15V
Input LOW Level Voltage Range (Purple Wire)	-2.0V	0V	+5.5V
Input HIGH Level Voltage Range (Purple Wire)	+9.0V	10V	+15V
Current into PWM Input (Purple Wire)	0mA	—	1.2mA
Source Current out of PWM Input (Purple Wire)	0mA	—	2mA
PWM Input Signal Frequency	500Hz	—	1500Hz
PWM Input Signal Positive Duty Cycle	0%	10-90%	100%

Notes

1. -PD PWM Dimmable version comes with an extra 2 wires +Purple/-Grey on the output side.
2. -PD PWM Dimmable version is not intended to dim below about 5% @ 0% Duty Cycle or 10% @ 10% Duty Cycle
3. -PD PWM dimmable version output will be 100% with Purple/Grey open and minimum with Purple/Grey Shorted.

-PD 2-Wire PWM Positive Dimming Scheme

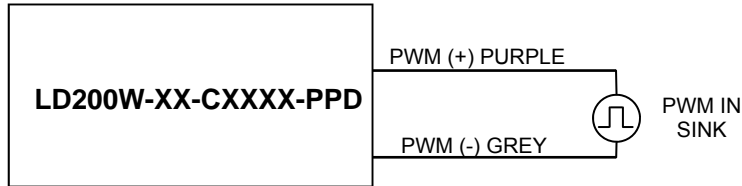

% Output Current vs. 1.0 kHz, Positive Duty Cycle Dimming Input

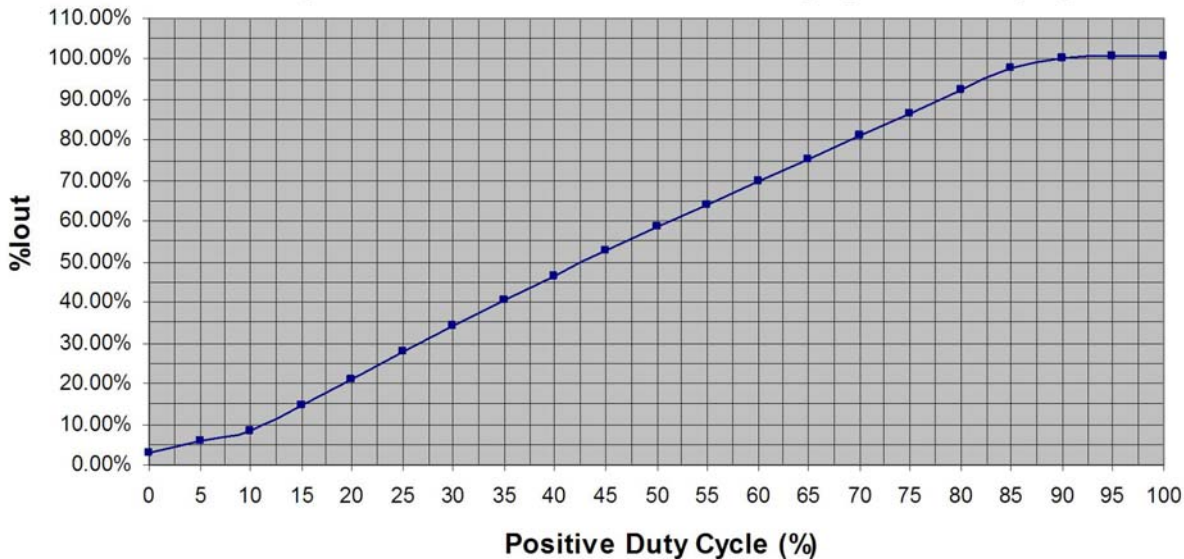

200 Watt - LD200W Series

CONSTANT VOLTAGE OR CONSTANT CURRENT LED DRIVER WITH DIMMING

Input Specifications

Parameter	Min.	Typ.	Max.	Notes/Conditions
Input Voltage	90 Vac	—	305 Vac	120, 230, 240, 277 Vac Nominal Values
Input Frequency	47 Hz	—	63 Hz	50/60Hz Nominal
Input AC Current	—	—	1.82 A	Measured at 120Vac/60Hz Input, Output Full load.
	—	—	0.96 A	Measured at 230Vac/60Hz Input, Output Full load.
Inrush Current (Peak)	—	—	60A	Measured at 277Vac/60Hz Input, Output Full Load, Ta 25°C, Cold Start 50% I _{peak} duration \approx 750 μ sec ($1/2 \cdot I_p^2 \cdot t$)
Inrush Current (I ² t)	—	—	1.35 A ² s	
Leakage Current	—	—	0.68mA	Measured at 120Vac/60Hz Input, Output Full load.
	—	—	0.75mA	Measured at 277Vac/60Hz Input, Output Full load.
THD	—	—	20%	Measured at 120, 230, 277Vac Input, Output \geq 60% Load, See Graphs
Power Factor (PF)	0.90	—	—	Measured at 120, 230, 277Vac Input, Output \geq 60% Load, See Graphs

Output Specifications

Parameter	Min.	Typ.	Max.	Notes/Conditions
DC Output Voltage	Per Table	—	Per Table	Per Tables on Page 2 & 3
DC Output Constant Current	-5%	Per Table	+5%	Per Tables on Page 2 & 3
Output Power	—	—	Per Table	Per Tables on Page 2 & 3
Ripple & Noise (V _{pk-pk})	—	—	5% V _o	20 MHz BW, Full load output in parallel with 0.1 μ F ceramic & 10 μ F Electrolytic. 120 Hz component (Flicker Free)
Ripple (I _{pk-pk})	—	—	5% I _o	20 MHz BW, Full load output in parallel with 0.1 μ F ceramic & 10 μ F Electrolytic. 120 Hz component (Flicker Free)
Start-up Time	—	150 mS	500 mS	Measured at 120Vac/60Hz Input, Output Full load.
Hold-up Time	—	30 mS	—	Typical @ 277Vac Input, Output Full load.

Environmental Specifications

Parameter	Min.	Typ.	Max.	Notes/Conditions
Case Temperature (T _c)	-30 °C	—	+90 °C	Measured at location specified on case.
Operating Temperature (T _a)	-30 °C	—	+60 °C	This is a reference range. T _c controls temperature range.
Storage Temperature (T _s)	-40 °C	—	+85 °C	Non operating temperature range.
Operating Humidity	—	—	95% RH	Relative Humidity, non-condensing.
Vibration	5 Hz	—	55 Hz	2G, 10 minutes/1 cycle, period 30 minutes, each along X, Y, Z axis.
MTBF	280,000 Hours	—	—	MIL-HDBK-217F Notice 2, T _a = 40C, Output Full Load.

Protection Specifications

Parameter	Min.	Typ.	Max.	Notes/Conditions
Output Short Circuit (SCP)	—	—	—	No Damage, Auto recovery after short is removed.
Output Over Current (OCP)	—	—	110% I _o	Constant Current Limiting circuit.
Output Over Voltage (OVP)	—	—	120% V _o	No Damage, Auto recovery after fault is removed.

200 Watt - LD200W Series

CONSTANT VOLTAGE OR CONSTANT CURRENT LED DRIVER WITH DIMMING

200W
 LD200W Series
 DIMMING

Safety Certification

Safety	Notes/Standards
UL Class P UL/CUL Listed	UL8750 & CAN/CSA C22.2 No. 250.13, UL Class P, UL Type HL
UL Type TL UL/CUL Recognized	UL8750, UL1310 for UL Class 2 & CAN/CSA C22.2 No. 250.13, UL Type HL & TL 90/84 °C
CE	EN61347-1, EN61347-2-13
Withstand Voltage	Input to Output: 3750 Vac. Parts use a GDT. Hipot cannot be done with Case or GND connected.
Isolation Resistance	Input to Output: >100 MΩ, 500VDC @ 25 °C, 70 % RH
Dimming Circuit	Dim+ Purple/Dim- Grey are considered part of the secondary circuit.

EMC Certification

Standard	Notes/Conditions
FCC, 47CFR Part 15	Class B
EN 55015	Limits and methods of measurement of radio disturbance characteristics of electrical lighting and similar equipment.
EN 61000-3-2	Part 3-2: Limits for harmonic current emissions Class C, ≥80% Rated Power
EN 61000-3-3	Part 3-3: Limitation of voltage changes, voltage fluctuations and flicker.
EN 61000-4-5	Part 4-5: Surge Immunity test, 2kV L-N, 4kV L-FG & N-FG
Energy Star	Energy Star transient protection: Ballast or driver shall comply with ANSI/IEEE C62.41.1-2002 and ANSI/IEEE C62.41.2-2002, Category A operation. The line transient shall consist of seven strikes of a 100 kHz ring wave, 2.5 kV level, for both common mode and differential mode.

Power Factor Curves (Typical)

PF vs. Output Power

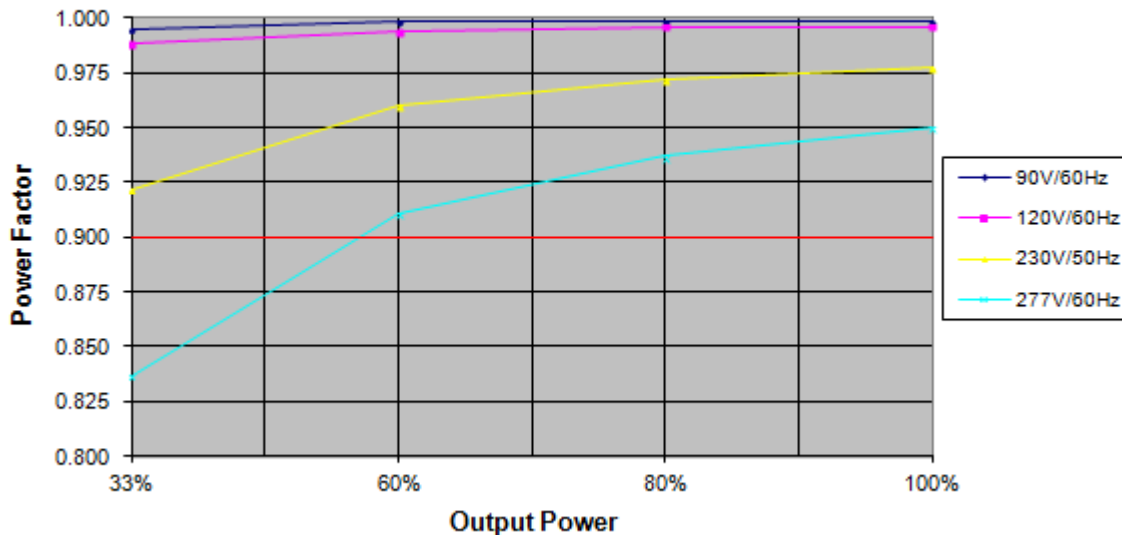

200 Watt - LD200W Series

CONSTANT VOLTAGE OR CONSTANT CURRENT LED DRIVER WITH DIMMING

THD Curves (Typical)

THD vs. Output Power

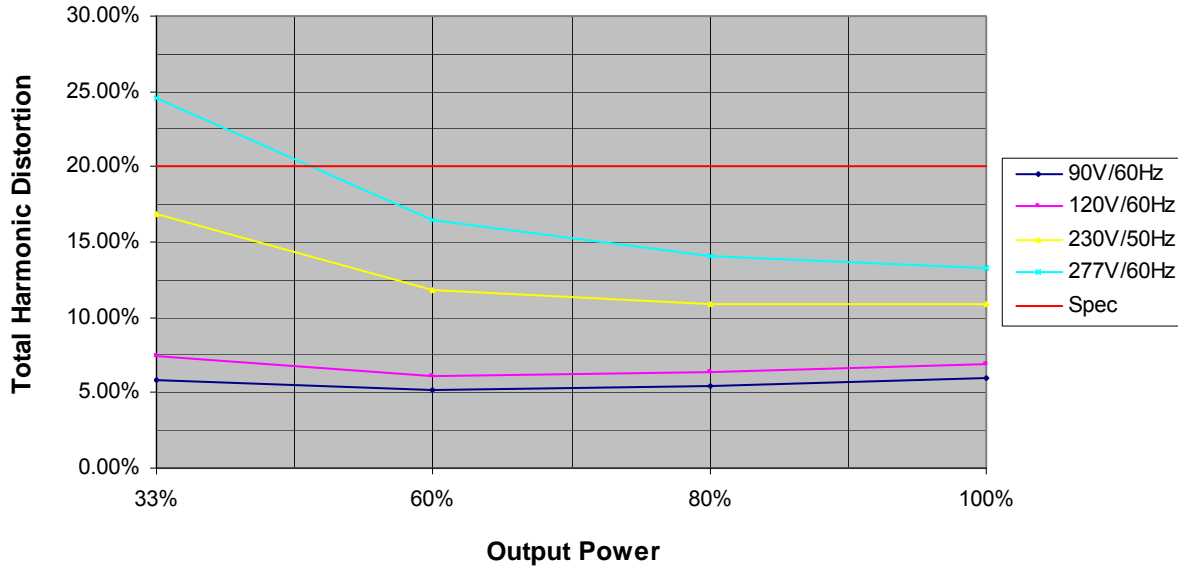

Efficiency Curve (Typical)

Efficiency vs. Output Power

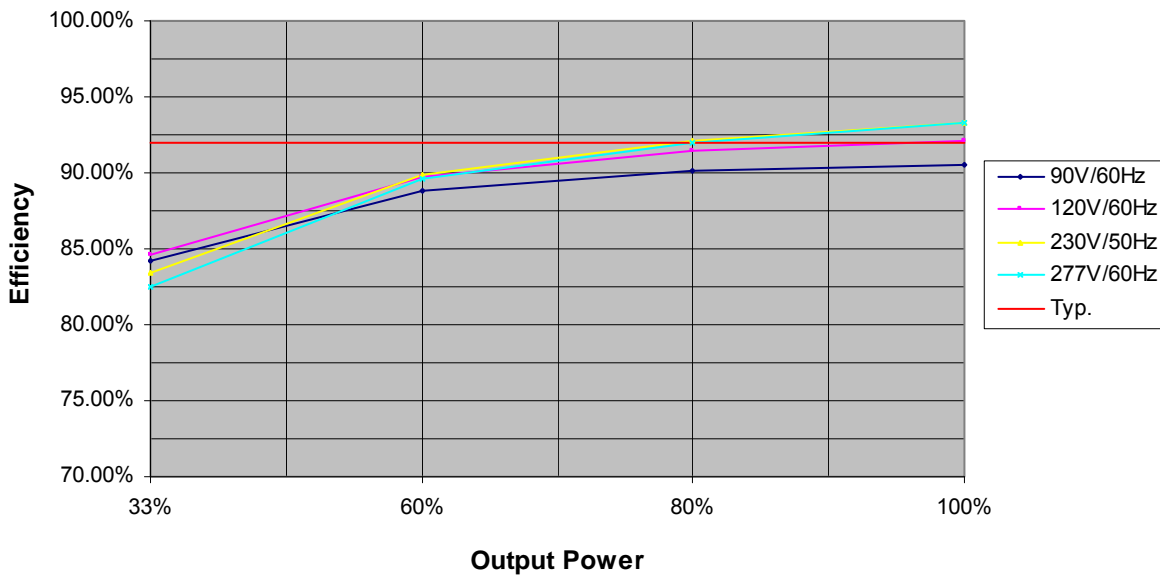

200 Watt - LD200W Series

CONSTANT VOLTAGE OR CONSTANT CURRENT LED DRIVER WITH DIMMING

200W
 LD200W Series
 DIMMING

Life vs. Ambient Temperature

LD200W Estimated Life Full Load @ 120Vac

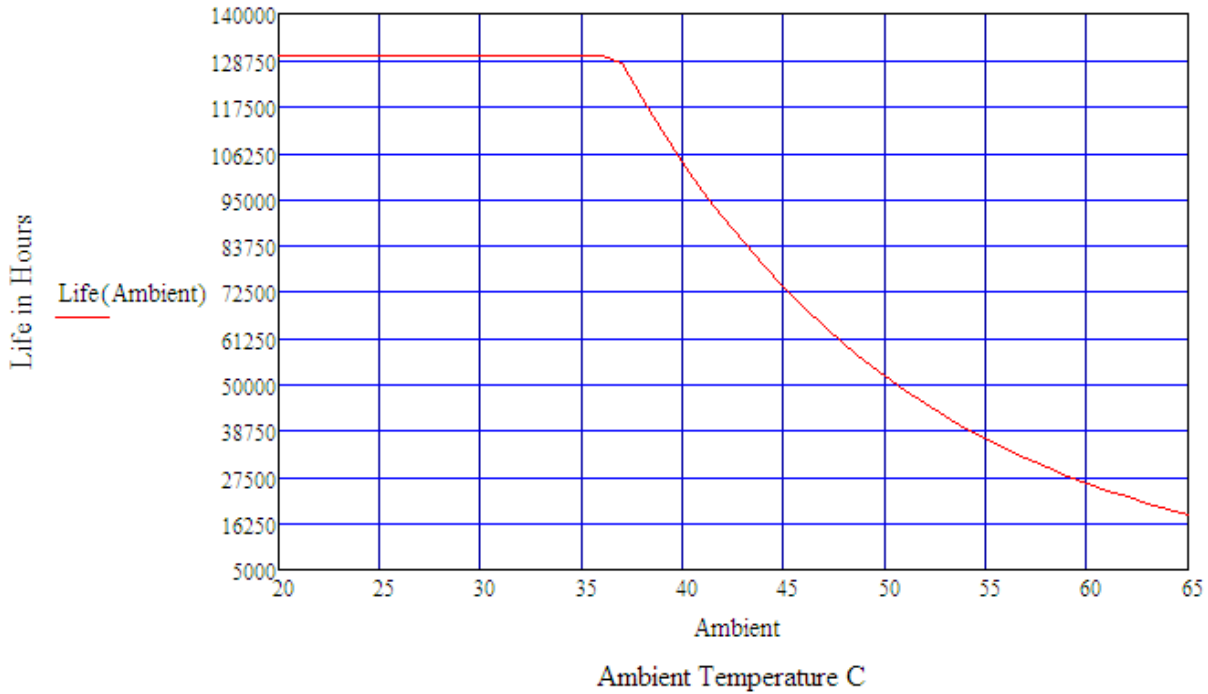

Life vs. Case (Tc) Temperature

LD200W Estimated Life Full Load @ 120Vac

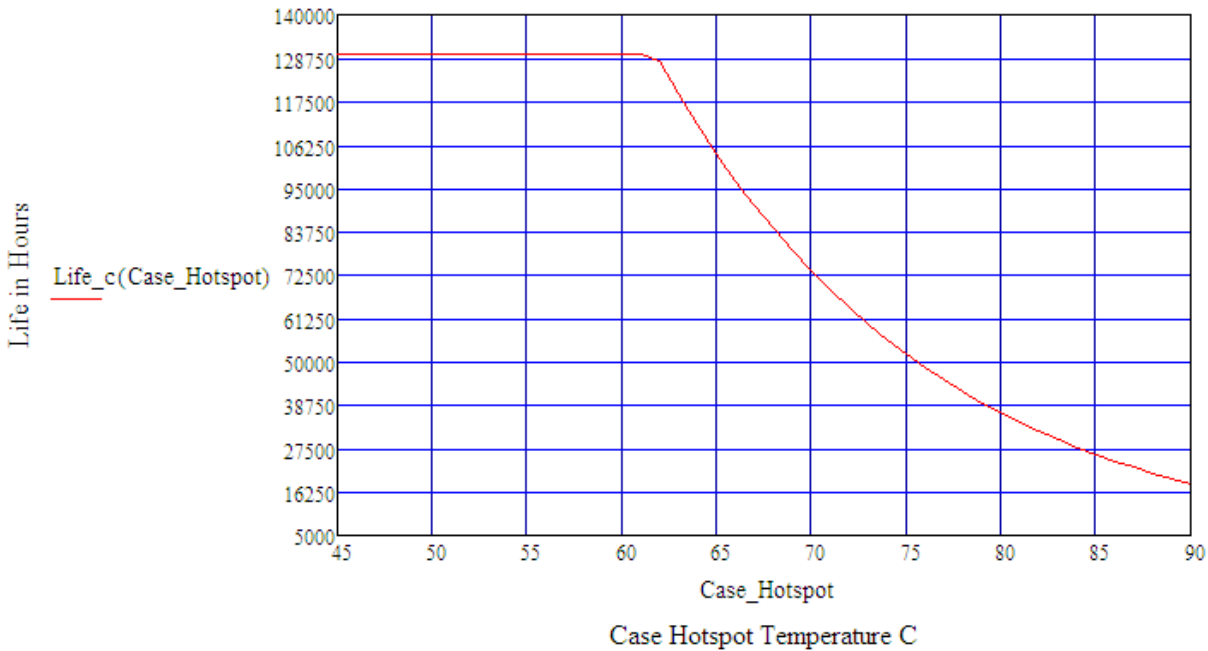

200W

LD200W Series

DIMMING



LED Optimized Drivers

200 Watt - LD200W Series

CONSTANT VOLTAGE OR CONSTANT CURRENT LED DRIVER WITH DIMMING

