

**ARM<sup>®</sup> Cortex<sup>®</sup>-M0**  
**32-bit Microcontroller**

**NuMicro<sup>®</sup> Family**  
**NuTiny-SDK-NANO102**  
**User Manual**

*The information described in this document is the exclusive intellectual property of Nuvoton Technology Corporation and shall not be reproduced without permission from Nuvoton.*

*Nuvoton is providing this document only for reference purposes of NuMicro microcontroller based system design. Nuvoton assumes no responsibility for errors or omissions.*

*All data and specifications are subject to change without notice.*

For additional information or questions, please contact: Nuvoton Technology Corporation.

[www.nuvoton.com](http://www.nuvoton.com)

**Table of Contents**

1 OVERVIEW ..... 4

2 NUTINY-SDK-NANO102 INTRODUCTION..... 5

    2.1 NuTiny -SDK-NANO102 Jumper Description ..... 6

        2.1.1 Power Setting ..... 6

        2.1.2 Debug Connector ..... 6

        2.1.3 USB Connector ..... 6

        2.1.4 Extended Connector ..... 6

        2.1.5 Reset Button..... 6

        2.1.6 Power Connector ..... 6

        2.1.7 Virtual COM Port Function Switch ..... 6

    2.2 Pin Assignment for Extended Connector ..... 8

    2.3 NuTiny-SDK-NANO102 PCB Placement ..... 10

3 How to Start NuTiny-SDK-NANO102 on the Keil  $\mu$ Vision<sup>®</sup> IDE ..... 11

    3.1 Keil uVision<sup>®</sup> IDE Software Download and Install ..... 11

    3.2 Nuvoton Nu-Link Driver Download and Install ..... 11

    3.3 Hardware Setup..... 11

    3.4 Example Program..... 12

4 How to Start NuTiny-SDK-NANO102 on the IAR Embedded Workbench ..... 13

    4.1 IAR Embedded Workbench Software Download and Install ..... 13

    4.2 Nuvoton Nu-Link Driver Download and Install ..... 13

    4.3 Hardware Setup..... 13

    4.4 Example Program..... 14

5 Starting to Use Nu-Link-Me 3.0 VCOM Function..... 15

    5.1 Downloading and Installing VCOM Driver ..... 15

    5.2 VCOM Mode Setting on NuTiny-SDK-NANO102..... 16

    5.3 Setup on the Development Tool..... 16

        5.3.1 Check the Using UART on the Keil  $\mu$ Vision<sup>®</sup> IDE..... 16

        5.3.2 Check the Target Device and Debug Setting ..... 16

        5.3.3 Build and Download Code to NuTiny-SDK-NANO102..... 18

        5.3.4 Open the Serial Port Terminal ..... 18

        5.3.5 Reset Chip ..... 19

6 NuTiny-SDK-NANO102 Schematic ..... 21

    6.1 NuTiny-EVB-NANO102 Schematic ..... 21

6.2 GPIO for 64 pin Schematic.....22

6.3 Nu-Link-Me Schematic.....23

7 REVISION HISTORY ..... 24

## 1 OVERVIEW

NuTiny-SDK-NANO102 is the specific development tool for NuMicro® NANO102 series. Users can use NuTiny-SDK-NANO102 to develop and verify the application program easily.

NuTiny-SDK-NANO102 includes two portions. One is NuTiny-EVB-NANO102 and the other is Nu-Link-Me. NuTiny-EVB-NANO102 is the evaluation board and Nu-Link-Me is its Debug Adaptor. Thus, users do not need other additional ICE or debug equipments.

## 2 NUTINY-SDK-NANO102 INTRODUCTION

NuTiny-SDK-NANO102 uses the NANO102SC2AN as the target microcontroller. Figure 2-1 is NuTiny-SDK-NANO102 for NANO102 series, the left portion is called NuTiny-EVB-NANO102 and the right portion is Debug Adaptor called Nu-Link-Me.

NuTiny-EVB-NANO102 is similar to other development boards. Users can use it to develop and verify applications to emulate the real behavior. The on board chip covers NANO102 series features. The NuTiny-EVB-NANO102 can be a real system controller to design users' target systems.

Nu-Link-Me is a Debug Adaptor. The Nu-Link-Me Debug Adaptor connects your PC's USB port to your target system (via Serial Wired Debug Port) and allows you to program and debug embedded programs on the target hardware. The Nu-Link-Me V3.0 also supports VCOM function, which gives users more flexibility when debug. To use Nu-Link-Me Debug adaptor with IAR or Keil, please refer to "Nuvoton NuMicro® IAR ICE driver user manual" or Nuvoton NuMicro® Keil ICE driver user manual" in detail. These two documents will be stored in the local hard disk when the user installs each driver. To use Nu-Link-Me 3.0 VCOM function, please refer to Chapter 5.

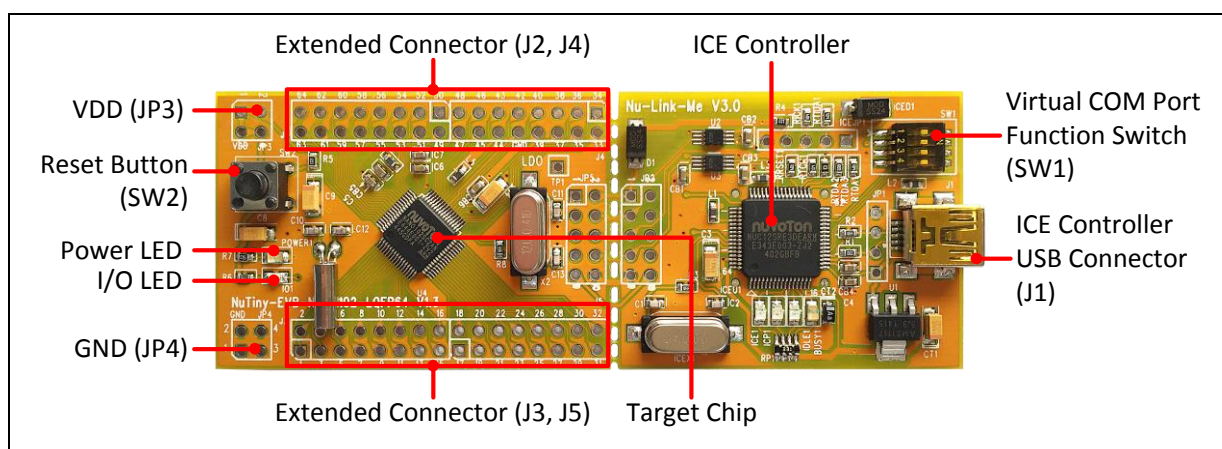

Figure 2-1 NuTiny-SDK-NANO102 (PCB Board)

## 2.1 NuTiny -SDK-NANO102 Jumper Description

### 2.1.1 Power Setting

- JP3:  $V_{DD}$  Voltage connector in NuTiny-EVB-NANO102
- J1: USB port in Nu-Link-Me

Model	JP3 $V_{DD}$	J1 ICE USB Port	MCU Voltage
Model 1	DC 3.3V Output	Connect to PC	DC 3.3V
Model 2	DC 1.8V ~ 3.6V Input	X	Voltage by JP2 Input

X: Unused.

### 2.1.2 Debug Connector

- JP5: Connector in target board (NuTiny-EVB-NANO102) for connecting with Nuvoton ICE adaptor (Nu-Link-Me)
- JP2: Connector in ICE adaptor (Nu-Link-Me) for connecting with a target board (NuTiny-EVB-NANO102)

### 2.1.3 USB Connector

- J1: Micro USB Connector in Nu-Link-Me connected to a PC USB port

### 2.1.4 Extended Connector

- J2, J3, J4, and J5: Show all chip pins in NuTiny-EVB-NANO102

### 2.1.5 Reset Button

- SW2: Reset button in NuTiny-EVB-NANO102

### 2.1.6 Power Connector

- JP3:  $V_{DD}$  connector in NuTiny-EVB-NANO102
- JP4: GND connector in NuTiny-EVB-NANO102

### 2.1.7 Virtual COM Port Function Switch

- **SW1:** Switch SW1 on/off before power on to enable/disable VCOM function. SW1 connects pin 60(PB.0/UART0\_RXD) and pin 61(PB.1/UART0\_TXD) in NuTiny-EVB-NANO102 with pin 22(PB.1/TXD) and pin 21(PB.0/RXD) in Nuvoton ICE adaptor (Nu-Link-Me V3.0). SW1 connects pin 30(VCOM) in Nuvoton ICE adaptor (Nu-Link-Me V3.0) to GND to enable VCOM function.

Switch Pin Number	Disable VCOM Mode	Enable VCOM Mode
1	Off	On
2	Off	On
3	Off	On
4	Off	On

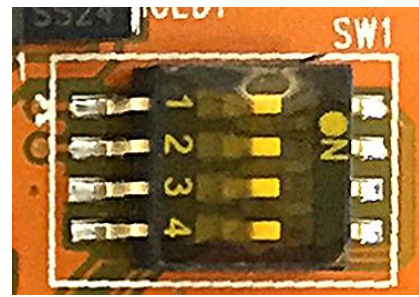

X: Unused.

## 2.2 Pin Assignment for Extended Connector

NuTiny-EVB-NANO102 provides NANO102SC2AN on board and the extended connector for LQFP 64-pin. Table 2-1 is the pin assignment for NANO102SC2AN.

Pin No	Pin Name	Pin No	Pin Name
01	PB.10/SPI0_MOSI1/UART1_RXD	33	PD.13/INT1
02	PB.11/TMR1_CNT/SPI0_MISO1/UART1_RTSn/TMR1_OUT	34	PD.14
03	PB.12/FCLK0/TMR0_CNT/SPI0_MOSI0/UART0_RTSn/TMR0_OUT	35	PD.15
04	PB.13/SPI0_MISO0/UART0_RXD	36	nRESET
05	PB.14/SPI0_CLK/UART0_TXD	37	LDO_CAP
06	PB.15/SPI0_SS0/UART0_CTSn	38	VDD
07	PC.0/PWM0_CH0/I2C0_SCL/SPI0_SS1	39	PF.0/TMR3_CNT/TMR3_OUT/X32_IN
08	PC.1/PWM0_CH1/I2C0_SDA	40	PF.1/TMR2_CNT/TMR2_OUT/X32_OUT
09	PC.2/PWM0_CH2/I2C1_SCL	41	VSS
10	PC.3/PWM0_CH3/I2C1_SDA	42	PF.2/INT1/TC3/UART1_RXD/XT1_IN
11	PC.4/INT0/SC0_CLK/UART1_CTSn	43	PF.3/INT0/TC2/UART1_TXD/XT1_OUT
12	PC.5/SC0_CD	44	AVSS
13	PC.6/SC0_DAT/UART1_RTSn	45	PA.0/AD0
14	PC.7/SC0_PWR/UART1_RXD	46	PA.1/AD1/ACMP0_P3/ACMP0_CHDIS
15	PC.8/SC0_RST/UART1_TXD	47	PA.2/INT0/AD2/ACMP0_P2/SC0_CLK/ACMP0_CHDIS
16	PC.9	48	PA.3/INT1/AD3/ACMP0_P1/SC0_DAT/ACMP0_CHDIS
17	PC.14/SC1_CD	49	PA.4/AD4/ACMP0_P0/SC0_CD/ACMP0_CHDIS
18	PC.15/SC1_PWR	50	PA.5/AD5/ACMP0_N/SC0_PWR/I2C1_SDA/SPI1_SS0/ACMP0_CHDIS
19	PD.0	51	PA.6/AD6/ACMP0_OUT/SC0_RST/ACMP0_CHDIS
20	PD.1	52	VREF
21	PD.2	53	AVDD
22	PD.3	54	PF.4/FCLK1/TC1/PWM0_CH2/CLK_Hz/CE_CLK
23	PD.4/SC1_RST	55	PF.5/TC0/PWM0_CH3/ACMP0_CHDIS/CE_DAT
24	PD.5	56	PA.12/ACMP1_P/I2C0_SCL/SPI1_MOSI



			0/UART0_TXD
25	PD.6	57	PA.13/ACMP1_N/I2C0_SDA/SPI1_MISO/UART0_RXD
26	PD.7/SC1_CLK	58	PA.14/I2C1_SCL/SPI1_CLK/ACMP0_CHDIS
27	PD.8/SC1_DAT	59	PA.15/TC3/ACMP1_OUT/I2C1_SDA/SPI1_SS0
28	PD.9/PWM0_CH3/SC1_RST	60	PB.0/FCLK1/UART0_TXD
29	PD.10/TC1/PWM0_CH2	61	PB.1/INT1/TC2/UART0_RXD
30	PD.11/TC0/PWM0_CH1	62	PB.2/TMR3_CNT/I2C0_SCL/SPI1_MOSI1/UART0_RTSn/TMR3_OUT
31	PD.12/FCLK0/TMR1_CNT/PWM0_CH0/CLK_Hz/TMR1_OUT	63	PB.3/TMR2_CNT/I2C0_SDA/SPI1_MISO1/UART0_CTSn/TMR2_OUT
32	VLCD	64	PB.6/FCLK0/SPI1_SS1/UART1_TXD

Table 2-1 Pin Assignment for NANO102

### 2.3 NuTiny-SDK-NANO102 PCB Placement

Users can refer to Figure 2-2 for the NuTiny-SDK-NANO102 PCB placement.

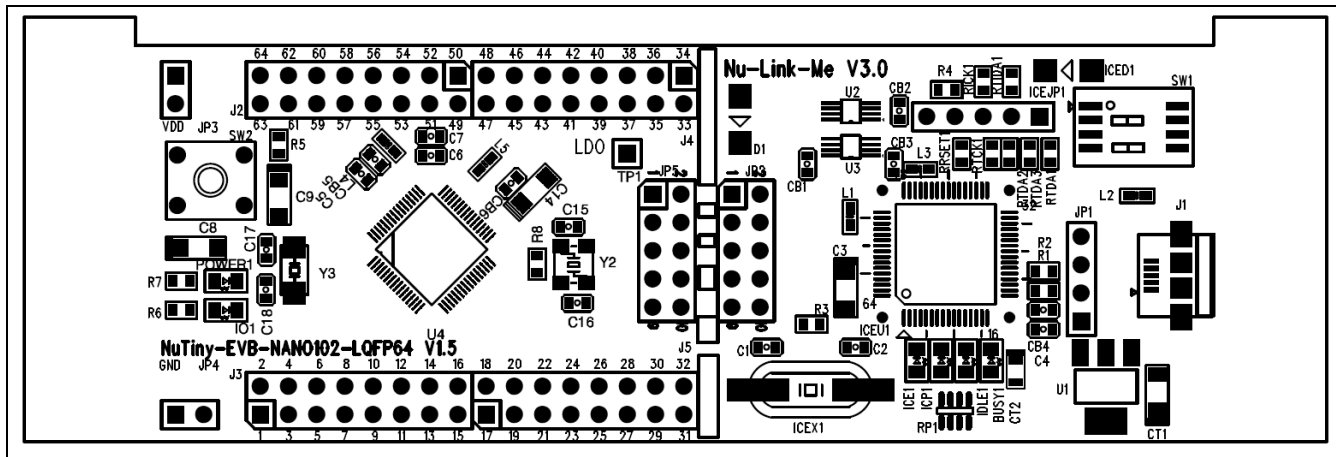

Figure 2-2 NuTiny-SDK-NANO102 PCB Placement

### 3 HOW TO START NUTINY-SDK-NANO102 ON THE KEIL MVISION® IDE

#### 3.1 Keil uVision® IDE Software Download and Install

Please visit the Keil company website (<http://www.keil.com>) to download the Keil  $\mu$ Vision® IDE and install the RVMDK.

#### 3.2 Nuvoton Nu-Link Driver Download and Install

Please visit the Nuvoton company NuMicro® website (<http://www.nuvoton.com/NuMicro>) to download “NuMicro® Keil  $\mu$ Vision® IDE driver” file. When the Nu-Link driver has been well downloaded, please unzip the file and execute the “Nu-Link\_Keil\_Driver.exe” to install the driver.

#### 3.3 Hardware Setup

The hardware setup is shown as Figure 3-1.



Figure 3-1 Hardware Setup

### 3.4 Example Program

This example demonstrates the ease of downloading and debugging an application on a NuTiny-SDK-NANO102 board. It can be found on Figure 3-2 list directory and downloaded from Nuvoton NuMicro® website.

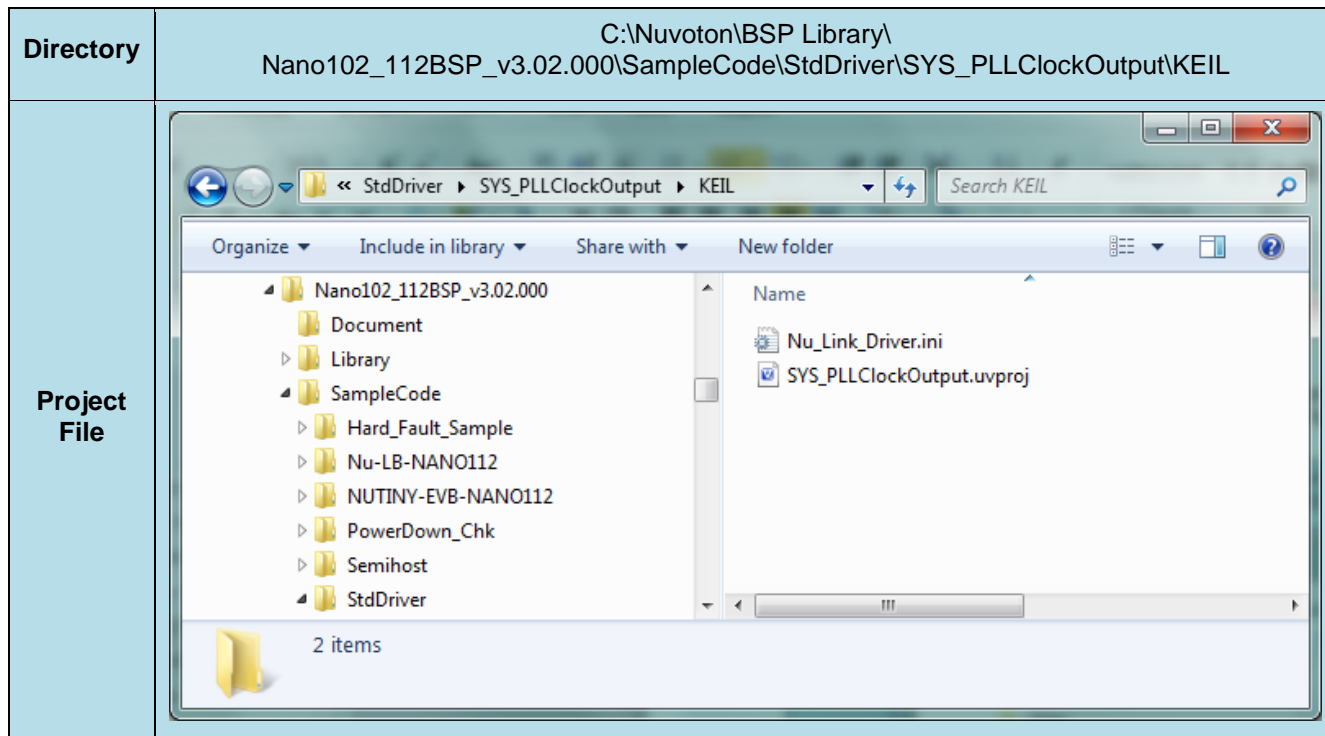









Figure 3-2 Example Directory

To use this example:

This sample code runs some functions about system manager controller and clock controller, and will show messages by Uart. Users can see the messages by following the steps of Chapter 5.

-  **Start µVision®**
- **Project-Open**  
Open the SYS.uvproj project file
-  **Project - Build**  
Compile and link the SYS application
-  **Flash – Download**  
Program the application code into on-chip Flash ROM
-  **Start debug mode**  
Using the debugger commands, you may:
  - ◆  Review variables in the watch window
  - ◆  Single step through code
  - ◆  Reset the device
  - ◆  Run the application

## 4 HOW TO START NUTINY-SDK-NANO102 ON THE IAR EMBEDDED WORKBENCH

### 4.1 IAR Embedded Workbench Software Download and Install

Please connect to IAR company website (<http://www.iar.com>) to download the IAR Embedded Workbench and install the EWARM.

### 4.2 Nuvoton Nu-Link Driver Download and Install

Please visit the Nuvoton company NuMicro<sup>®</sup> website (<http://www.nuvoton.com/NuMicro> ) to download the “NuMicro<sup>®</sup> IAR EWARM Driver” file. When the Nu-Link driver has been well downloaded, please unzip the file and execute the “Nu-Link\_Keil\_Driver.exe” to install the driver.

### 4.3 Hardware Setup

The hardware setup is shown as Figure 4-1.

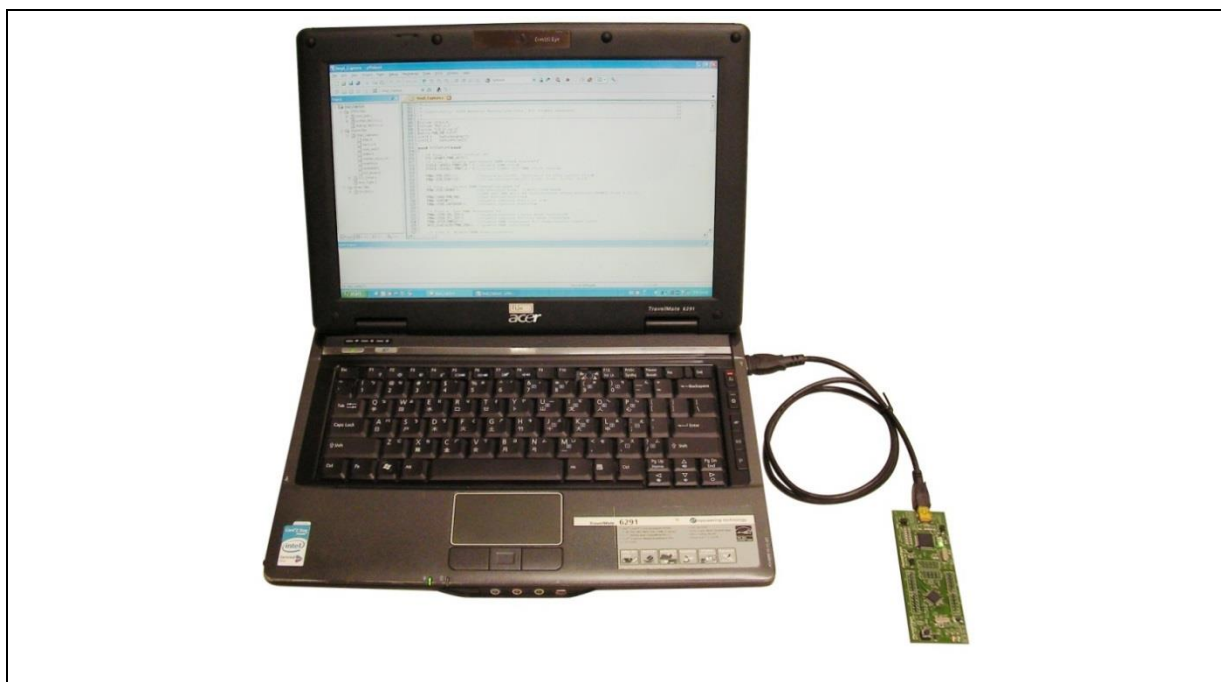

Figure 4-1 Hardware Setup

### 4.4 Example Program

This example demonstrates the ease of downloading and debugging an application on a NuTiny-SDK-NANO102 board. It can be found on Figure 4-2 list directory and downloaded from Nuvoton NuMicro® website.

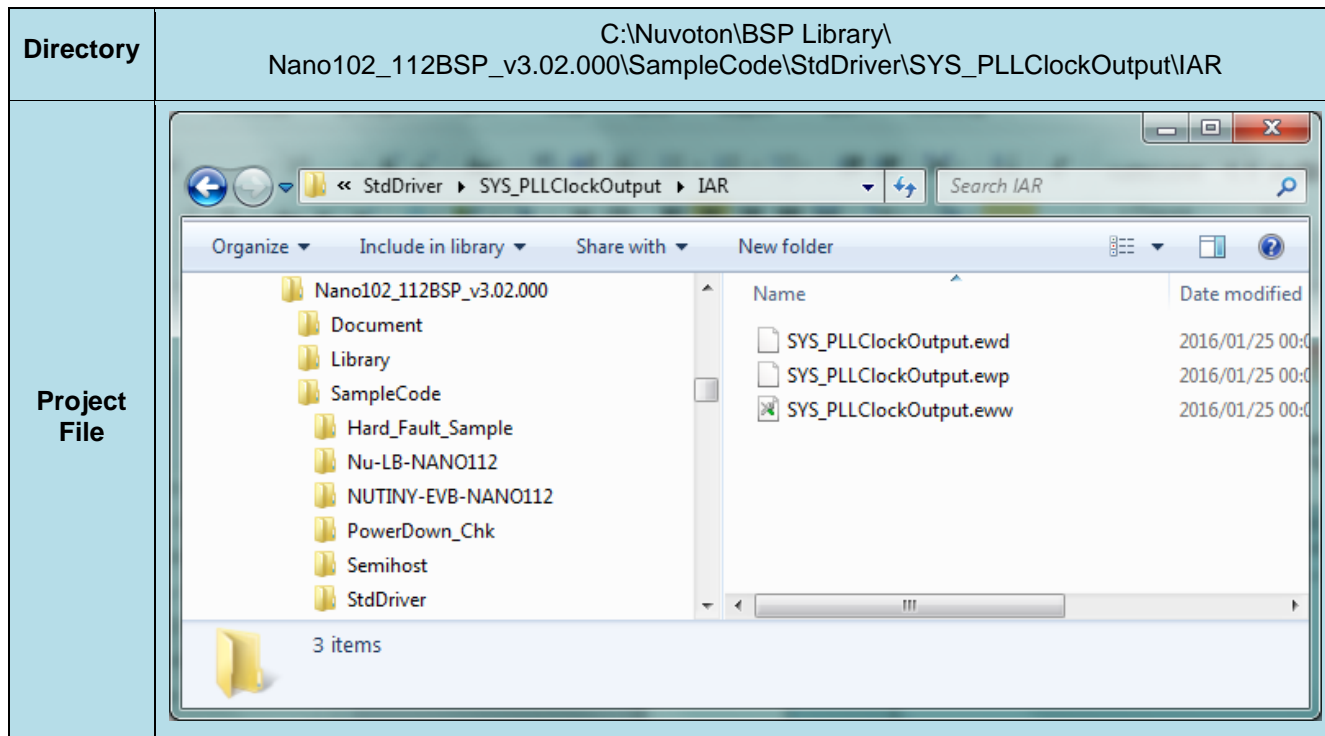







Figure 4-2 Example Directory

To use this example:

This sample code runs some functions about system manager controller and clock controller, and will show messages by Uart. Users can see the messages by following the steps of Chapter 5.

-  Start IAR Embedded Workbench
-  Project – Download and Debug  
Program the application code into on-chip Flash ROM
- File-Open-Workspace  
Open the SYS.eww workspace file
-  Single step through code
-  Reset the device
-  Project - Make  
Compile and link the SYS application
-  Run the application

## 5 STARTING TO USE NU-LINK-ME 3.0 VCOM FUNCTION

### 5.1 Downloading and Installing VCOM Driver

Please connect to Nuvoton NuMicro® website (<http://www.nuvoton.com/NuMicro>) to download the “NuMicro® ICP Programming Tool” file. After the ICP Programming Tool driver is downloaded, please unzip the file and execute the “ICP Programming Tool.exe”. Simply follow the installation and optional steps to install ICP Programming Tool and Nu-Link USB Driver, which included VCOM driver.

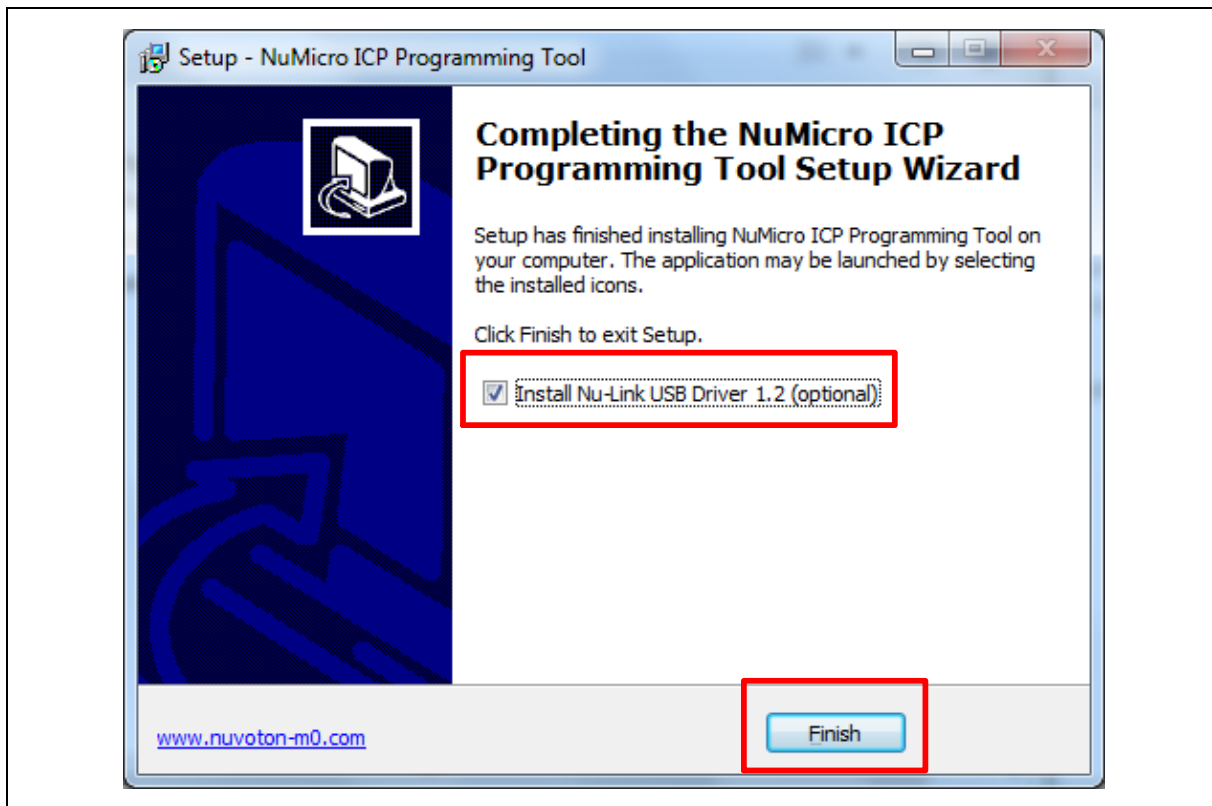

Figure 5-1 Optional Step after ICP Programming Tool Installation

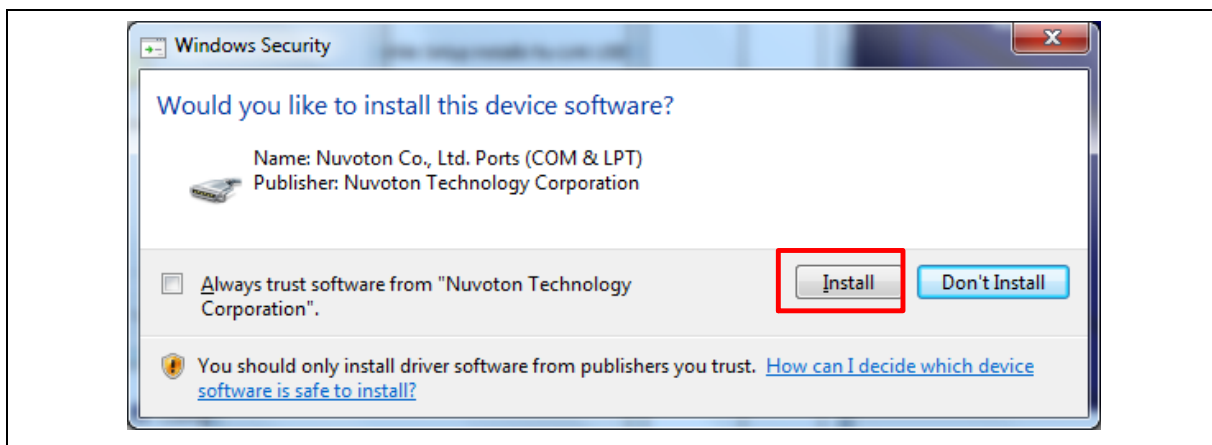

Figure 5-2 Install Nuvoton COM&LPT Driver

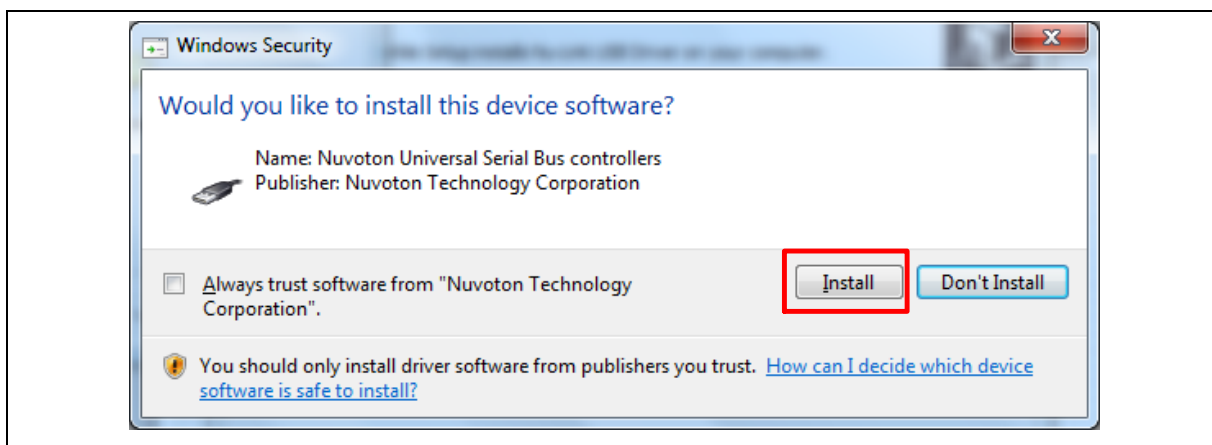

Figure 5-3 Install Nuvoton Universal Serial Bus Controllers

## 5.2 VCOM Mode Setting on NuTiny-SDK-NANO102

Before the NuTiny-SDK-NANO102 is connected to the PC, please enable SW1 VCOM function by switching on SW1. The NuTiny-EVB-NANO102 transmits through UART0 to VCOM to send out data. Switch SW1 off when using UART0 function without VCOM function.

After connected USB port in Nu-Link-Me to the PC, user can find a “Nuvoton Virtual Com Port” from Device Manager as Figure 5-4.

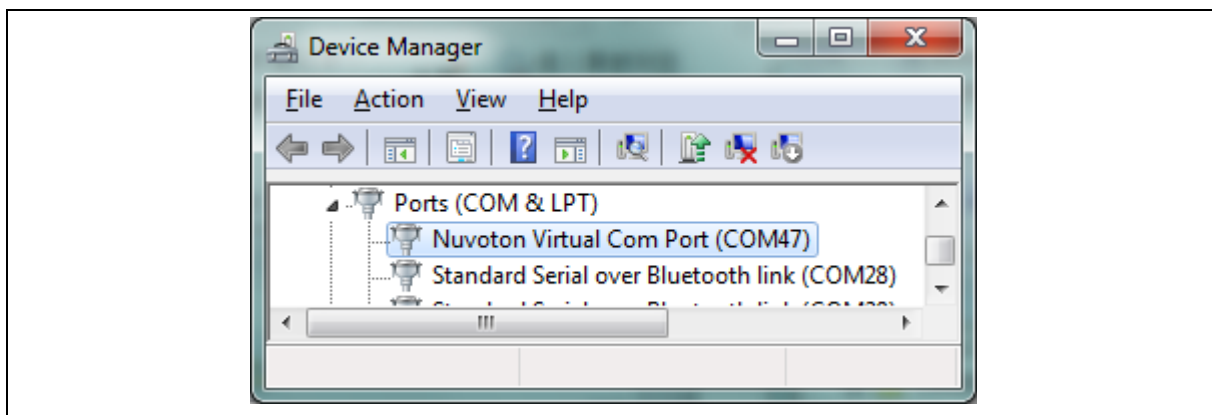

Figure 5-4 Nuvoton Virtual Com Port

## 5.3 Setup on the Development Tool

The example is demonstrated on the Keil  $\mu$ Vision<sup>®</sup> IDE.

### 5.3.1 Check the Using UART on the Keil $\mu$ Vision<sup>®</sup> IDE

Please open the project and find retarget.c (which can be found in \\Nuvoton\BSP Library\Nano102\_112BSP\_v3.02.000\Library\StdDriver\src\retarget.c) to check the using UART is UART0. The setting has to be the same as the using UART in the NuTiny-EVB-NANO102.

### 5.3.2 Check the Target Device and Debug Setting

The target device has to be the same as the setting in Debug. Please click “Target Option” to open the Option windows, and find the setting in “Device”, “Debug”, and “Utilities” page. Please follow the steps below to check the setting.



Step 1

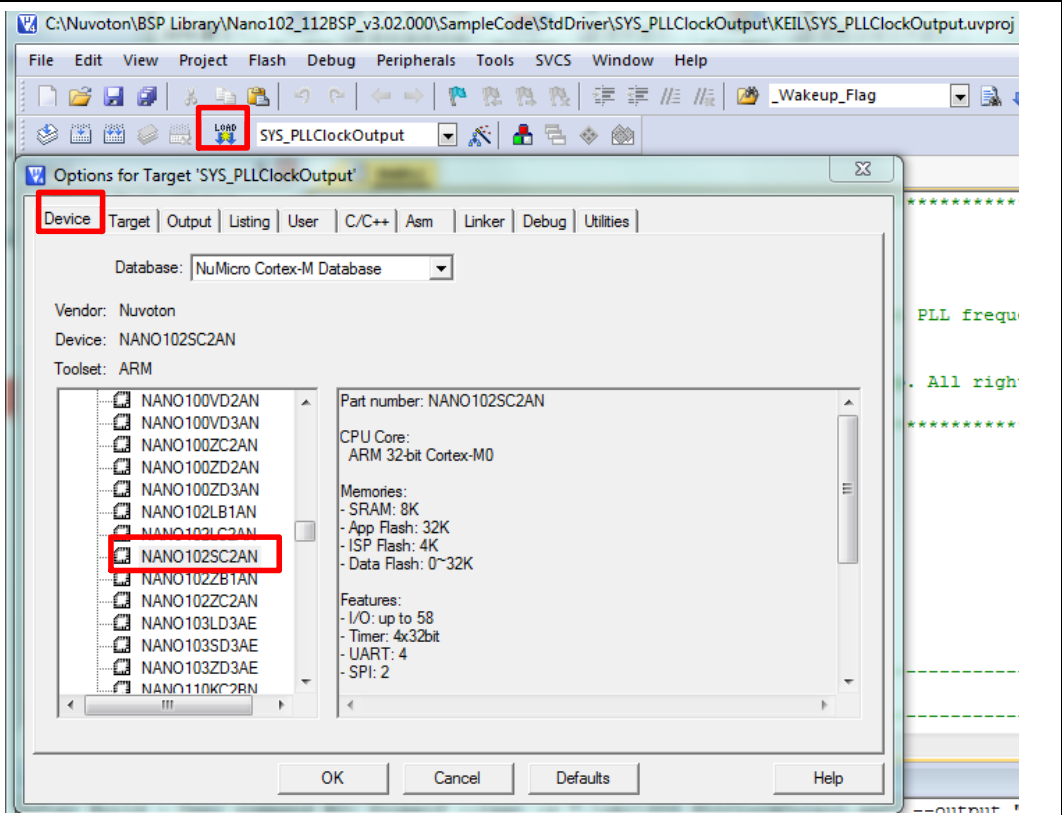

Step 2

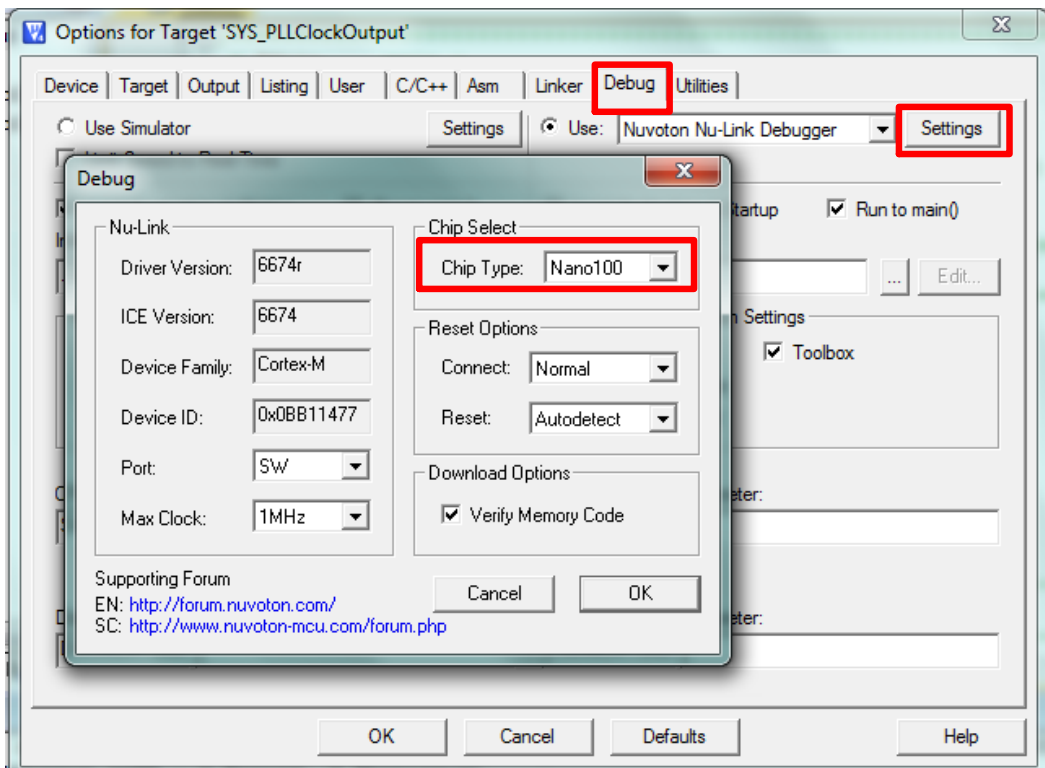

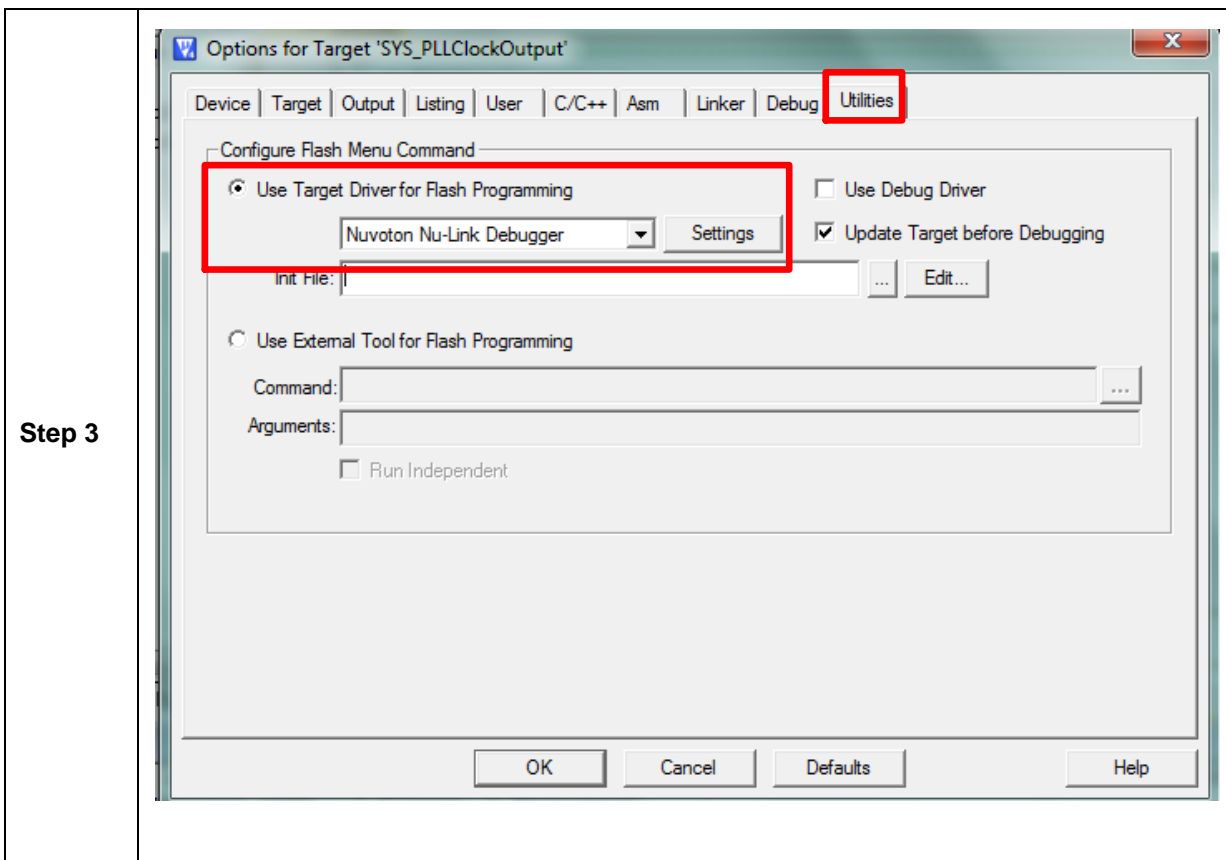

### 5.3.3 Build and Download Code to NuTiny-SDK-NANO102

Please build the project and download code to NuTiny-SDK-NANO102.

### 5.3.4 Open the Serial Port Terminal

User can use serial port terminal, PuTTY for example, to print out debug message.

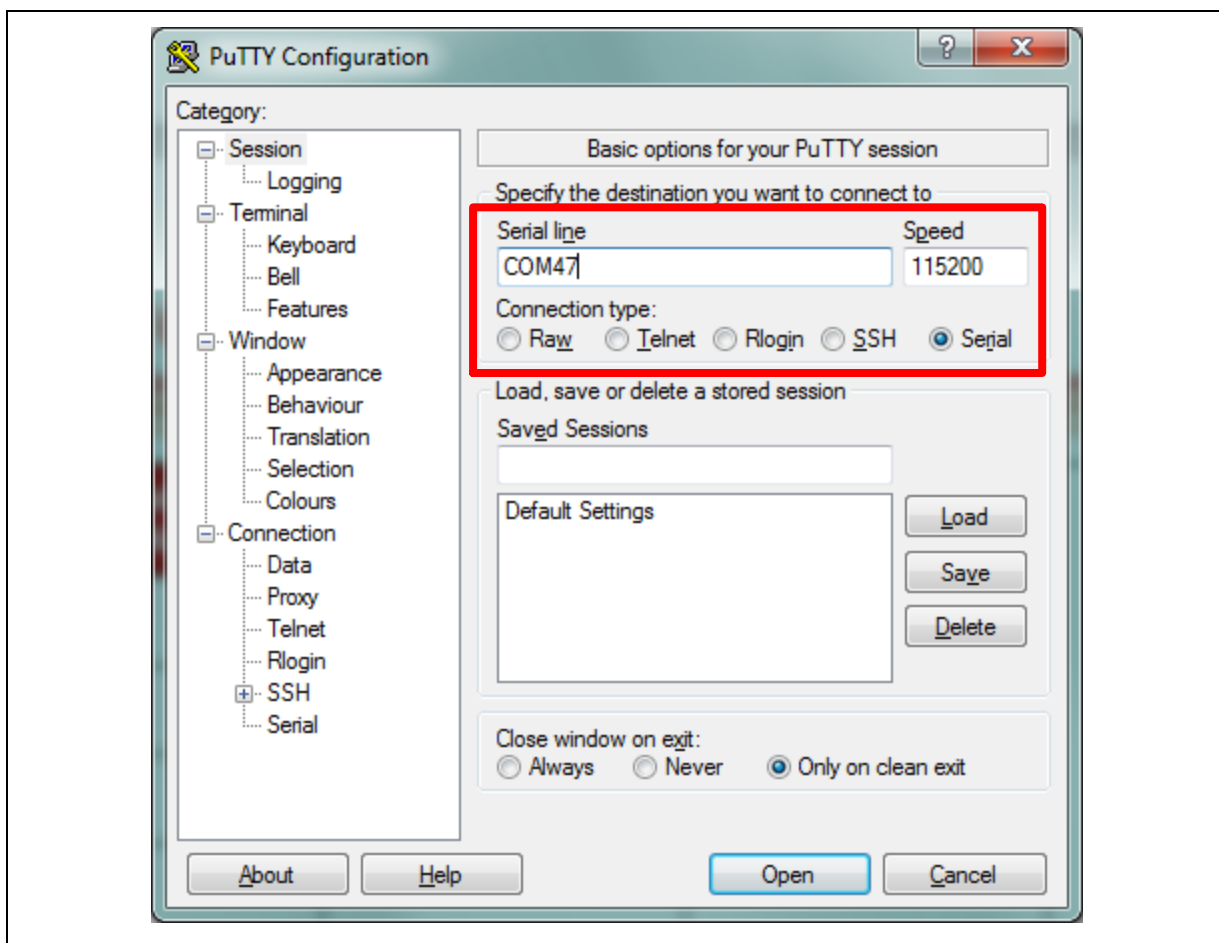

Figure 5-5 Set Baud Rate

### 5.3.5 Reset Chip

After pushing the reset button, the chip will reprogram application and print out debug message.

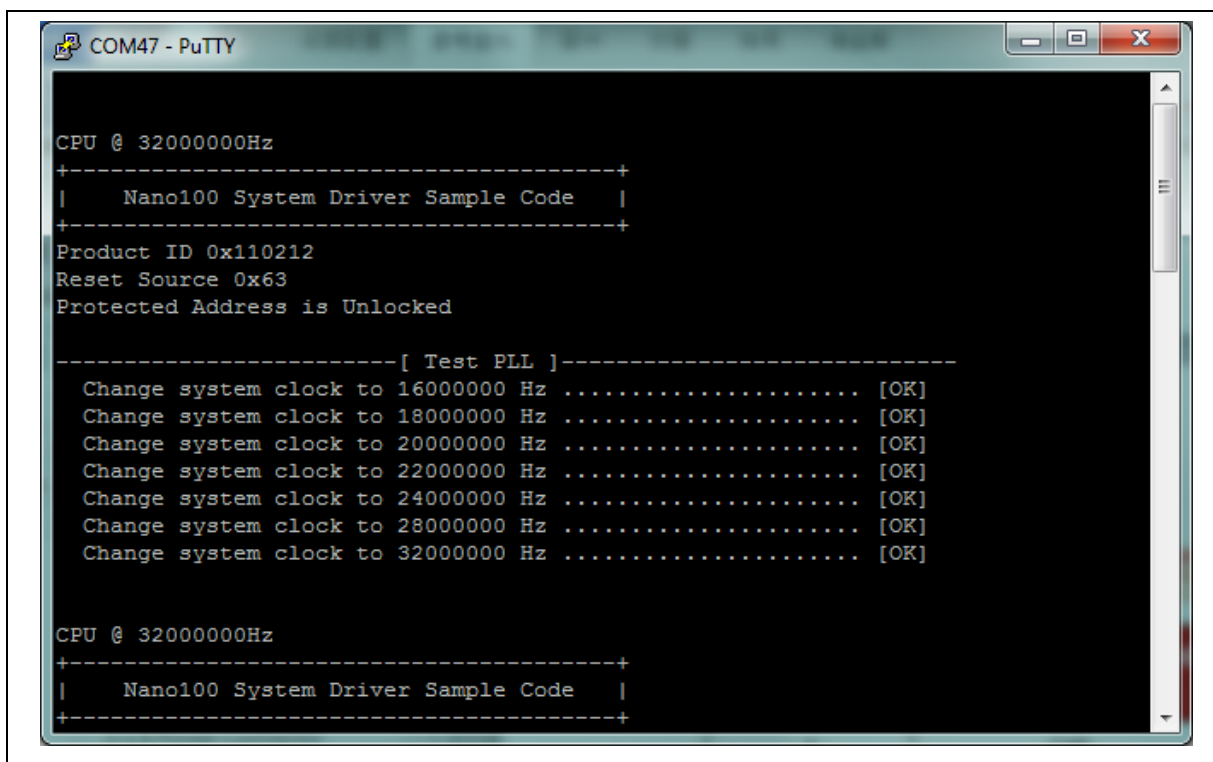
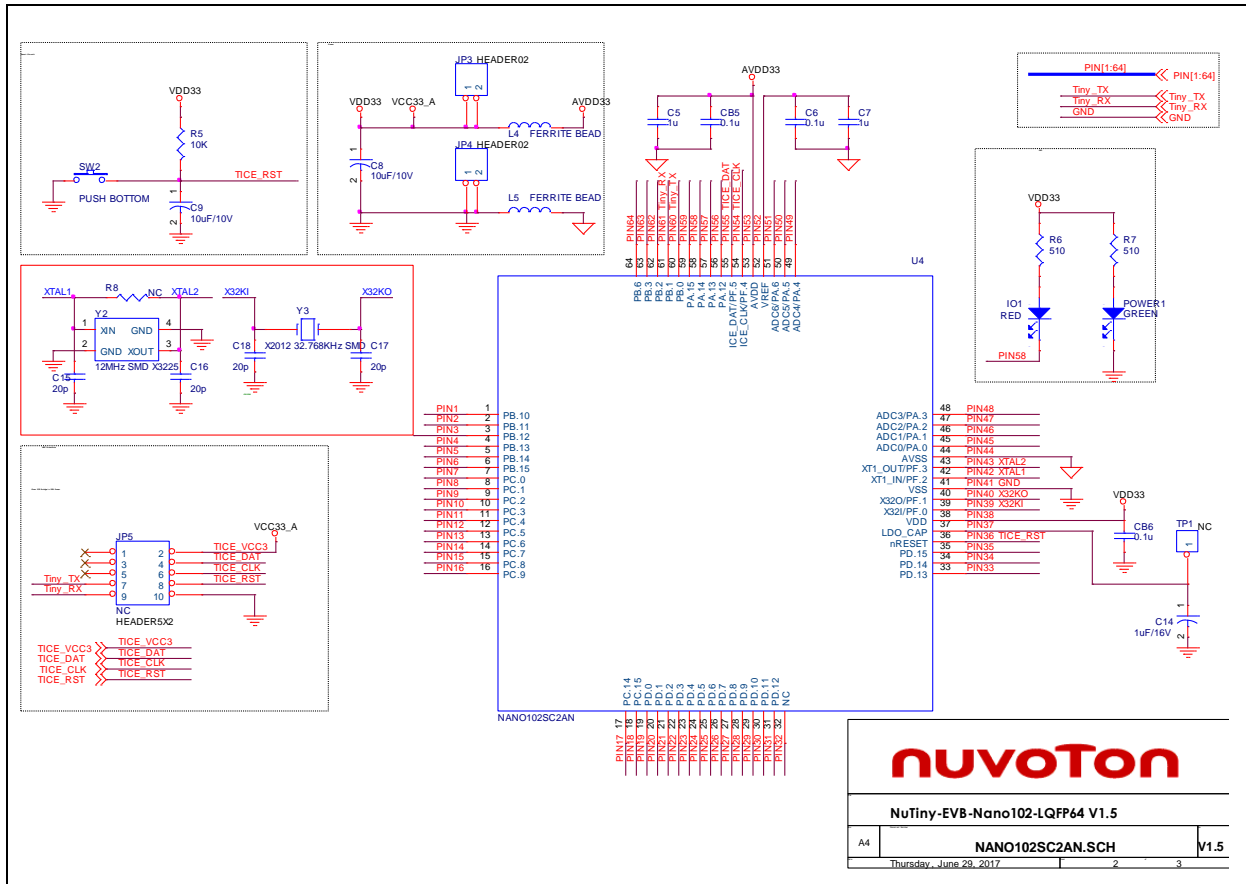

Figure 5-6 Serial Port Terminal Windows

**Notice:** Please switch SW1 on before the NuTiny-SDK-NANO102 connects to the PC. When the NuTiny-SDK-NANO102 connects to the PC with SW1 switch on, PC will detect VCOM as a USB device and the detection will only be processed once. VCOM will not function if switch on SW1 after the connection.

## 6 NUTINY-SDK-NANO102 SCHEMATIC

### 6.1 NuTiny-EVB-NANO102 Schematic



6.2 GPIO for 64 pin Schematic

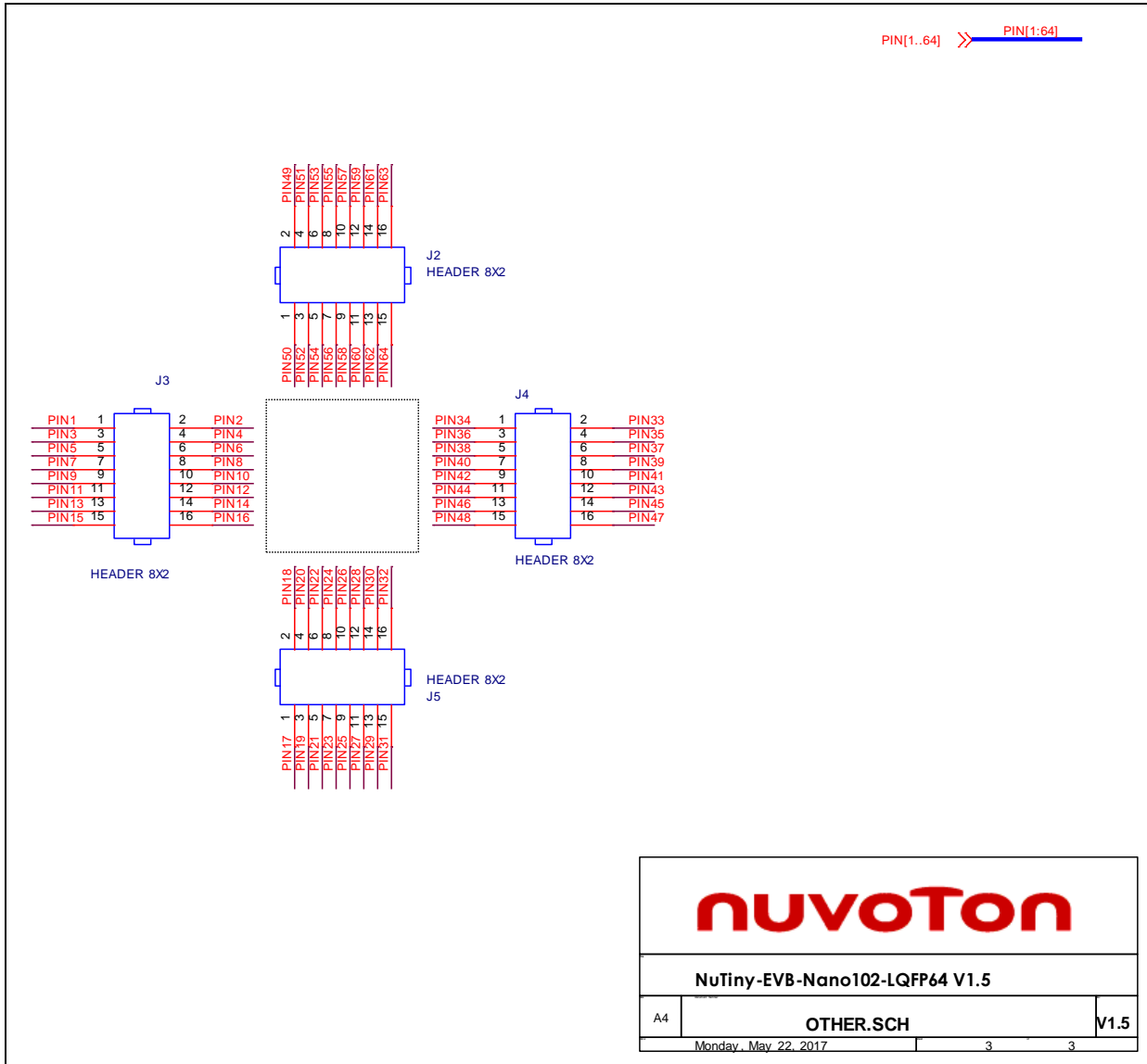

<b>nuvoTon</b>		
NuTiny-EVB-Nano102-LQFP64 V1.5		
A4	OTHER.SCH	V1.5
Monday, May 22, 2017		3 3

6.3 Nu-Link-Me Schematic

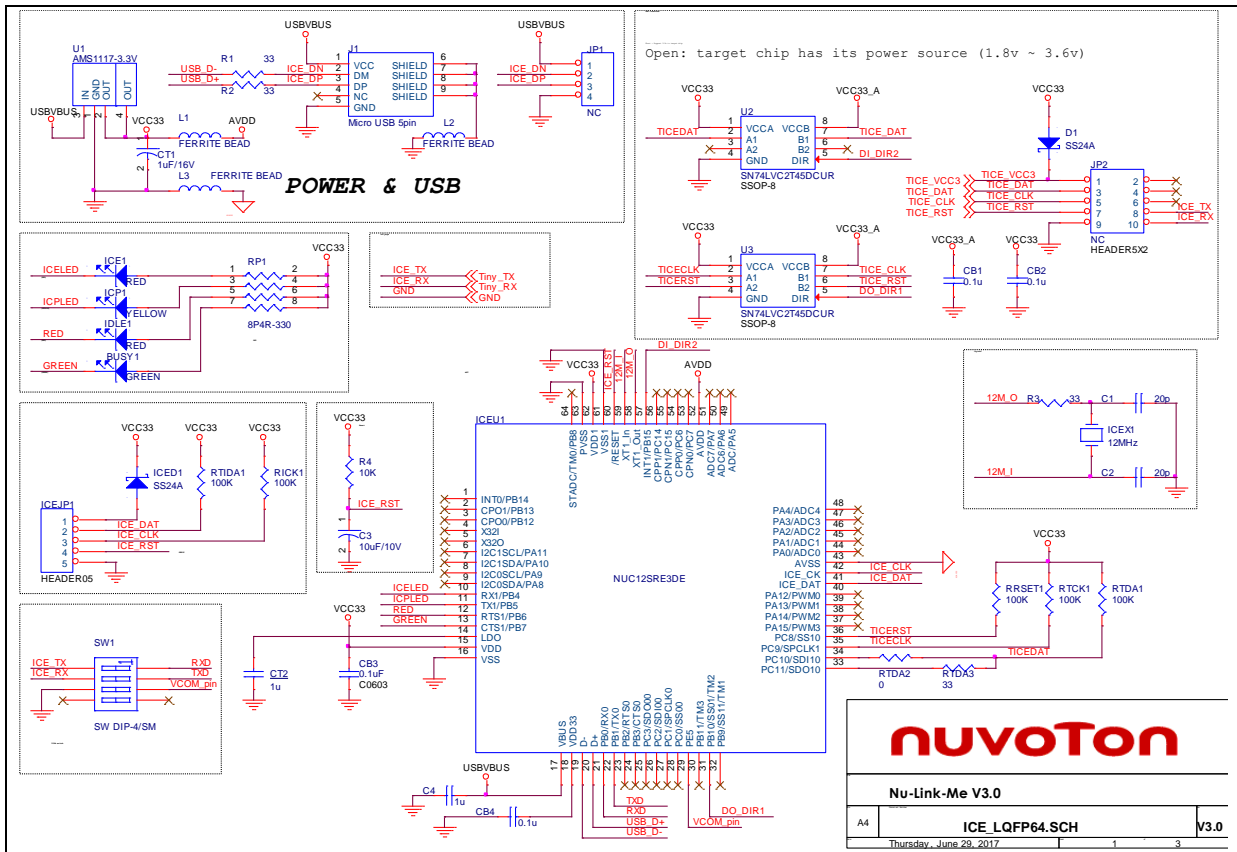

## 7 REVISION HISTORY

Date	Revision	Description
2018.02.26	1.00	1. Initially issued.



### Important Notice

Nuvoton Products are neither intended nor warranted for usage in systems or equipment, any malfunction or failure of which may cause loss of human life, bodily injury or severe property damage. Such applications are deemed, "Insecure Usage".

Insecure usage includes, but is not limited to: equipment for surgical implementation, atomic energy control instruments, airplane or spaceship instruments, the control or operation of dynamic, brake or safety systems designed for vehicular use, traffic signal instruments, all types of safety devices, and other applications intended to support or sustain life.

All Insecure Usage shall be made at customer's risk, and in the event that third parties lay claims to Nuvoton as a result of customer's Insecure Usage, customer shall indemnify the damages and liabilities thus incurred by Nuvoton.

---

*Please note that all data and specifications are subject to change without notice.  
All the trademarks of products and companies mentioned in this datasheet belong to their respective owners.*