

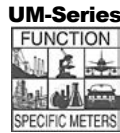

Optional
super bright
LEDs



Optional Green
LED Display



UM-45-DCV 2/20/200 Volt DC Meter

A cost-effective Utility Meter for General Purpose
Single or Differential DC Voltage Measurement.

4 1/2 DIGIT with 0.56" LEDs
in a NEMA type 1 Style Case

General Features

The UM-45-DCV is a very reliable utility DC voltage measuring meter with three built-in ranges of 2V/20V/200V. It is a cost-effective solution to most DC voltage measuring applications since it may be used to measure single-ended as well as differential signals and is easily scaled to any desired process engineering unit.

Typical Application Connections

DC Volts Single-ended measurement with
a Resolution of 100 milliVolt.

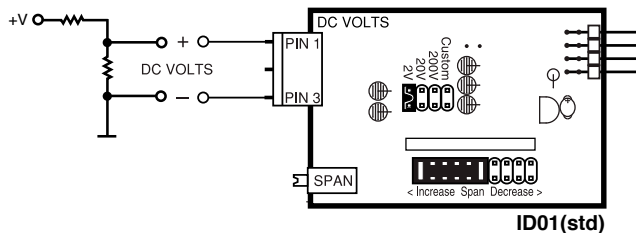

DC Volts Differential measurement with
a Resolution of 100 milliVolt.

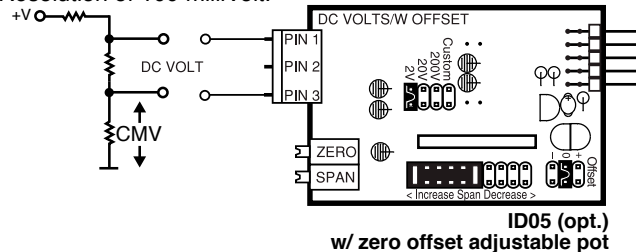

Max CMV (common mode voltage) is 50V.*
*Because CMV is common with meter ground, higher CMV inputs to a max of 1KV, require mechanical isolation of all contactable meter parts.

Specifications

Input Configuration:Single-ended, however the isolated power supply enables differential measurements up to a maximum common mode of 50V.*
Optional zero pot to offset the reading displayed.
(See Ordering Information)

Full Scale Ranges:.....Three header selectable ranges of $\pm 2V$, $\pm 20V$ and $\pm 200V$ DC

Input Impedance:.....1M Ω minimum

A/D Converter:.....12 Bit Dual Slope

Accuracy: $\pm(0.05\%$ of reading plus 2 counts)

Temperature Coefficient: 100ppm/ $^{\circ}C$ (Typical)

Warm Up Time:.....2 minutes to specified accuracy

Conversion Rate:.....3 conversions per second (Typical)

Display:.....4 1/2 digit 0.56" Red LED display (std), Green or Super Bright Red are optional. Range -19999 to 19999 counts.

Decimal Selection:Header under face plate, X•X•X•X•

Overrange Indication:1 (MSD) displayed with all other digits blank

Power Supply (PS6 std):.. 120/240V AC, 50/60/400 Hz. approx 1.5W.
(PS7 opt) ..Isolated Switcher. 9 to 36V DC/12 to 24V AC
(PS8 opt) ..5 VDC/200mA

Operating Temperature:...-10 to 50 $^{\circ}C$

Storage Temperature:-20 to 70 $^{\circ}C$.

Relative Humidity:95% (non-condensing)

Case Dimensions:.....Bezel 3.78"Wx1.89"H (96mm x 48mm)
Depth behind bezel 3.36" (83.5mm) Plus 0.5 to .9" (12.7 to 22.8mm) depending on connector used.

Weight:.....NW. 12oz (0.34kg)
15.6oz (0.44kg). when packed.

UM-Series utility meters for switchboard and process indication

UM-35-ACAAC amps, Scaled or True RMS, (1 or 5 Amp internal shunt), 3.5 digit.

UM-35-ACVAC volts, Scaled or True RMS. 199.9V AC/700V AC header selectable ranges, 3.5 digit.

UM-35-DCADC mV $\pm 20mV/\pm 50mV/\pm 100mV/\pm 200mV$ header selectable ranges, 3.5 digit

UM-35-DCVDC Volts $\pm 2V/\pm 20V/\pm 200V$ DC header selectable ranges, 3.5 digit.

UM-40-ACAAC amps, Scaled or True RMS, (1 or 5 Amp internal shunt), 4.0 digit.

UM-40-ACVAC volts, Scaled or True RMS. 199.9V AC/700V AC header selectable ranges, 4.0 digit.

UM-45-DCADC mV $\pm 20mV/\pm 50mV/\pm 100mV/\pm 200mV$ header selectable ranges, 4.5 digit

UM-45-DCVDC Volts $\pm 2V/\pm 20V/\pm 200V$ DC Header selectable ranges, 4.5 digit.

UM-35-CLProcess 4 to 20mA (100.0), easily user scalable in engineering units from -1999 to +1999. 3.5 digit

UM-35-HZ15Hz to 199.9Hz or optional 40Hz to 400Hz up to 500V AC, 3.5 digit.

UM-35-SGPressure, strain gage and load cell, 4 and 6 wire, 5V DC excitation, Header Selectable Sensitivity 2mV/V, 5mV/V, 10mV/V, 20mV/V, 3.5 digit

UM-35-TC-JF ..J thermocouple input, 1 $^{\circ}$ resolution, order $^{\circ}C$ or $^{\circ}F$, 3.5 digit

UM-35-TC-KF ..K thermocouple input, 1 $^{\circ}$ resolution, order $^{\circ}C$ or $^{\circ}F$, 3.5 digit

UM-35-RTD/F ..100 Ω platinum RTD, 3 or 4 wire, order $^{\circ}C$ or $^{\circ}F$ and 0.1 $^{\circ}$ or 1 $^{\circ}$, 3.5 digit

UM-45-CLProcess 4 to 20mA (100.0), easily user scalable in engineering units from -19999 to +19999. 4.5 digit

Component Layout

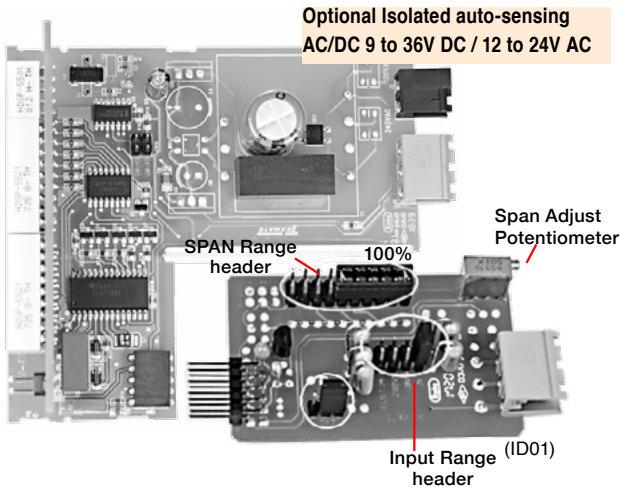

Decimal selection is made by moving the jumper to the indicated position on the header for the decimal required on the front of the display board.

Decimal Point Selection

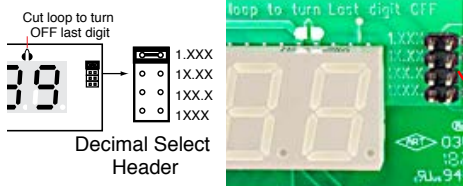

To open meter, insert a flat head screwdriver or similar instrument in both slots on the side of the cover and pry open. The UM-Series meters slide out from the front of the case as a complete assembly.

Signal Conditioning Components

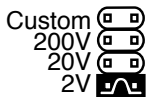

INPUT RANGE Header

Range values are marked on the PCB. After selecting a new range with the single jumper clip, recalibration is required.

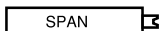

SPAN Potentiometer (Pot)

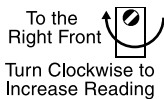

The 15 turn SPAN pot is always on the right side (as viewed from the front of the meter). Typical adjustment is 100% of the input signal range.



ZERO Potentiometer (Pot)

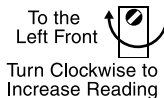

The Optional ZERO pot when installed is always to the left of the SPAN pot (as viewed from the front of the meter). Typically it enables the displayed reading to be offset ± 100 counts.

Optional Face Plate Descriptors



To customize the face plate, clear adhesive label containing various popular descriptors may be ordered. Choose the descriptor desired, peel off the adhesive backing and align the descriptor in the center right of the faceplate.

P.N.: 75-DESCRIPTR

Calibration Procedure

1. Select the required full scale voltage range by repositioning the jumper clip on the Range Select Header. A range of 2, 20 or 200V DC full scale may be selected.
2. Apply an input of 0 volts. The meter will autozero and display 0000. If the zero needs to be offset, order the ID05 option and adjust Zero Offset pot until the meter reads 0000.
3. Apply a known high input signal that is within the full scale voltage range selected.
4. Adjust the Span Pot until the meter displays the required reading for the signal being applied. e.g. 1VDC=1.000
5. The UM-45-DCV is now calibrated and ready for use. (Whenever you select a new range, you must re-calibrate to meet the specified accuracy.)

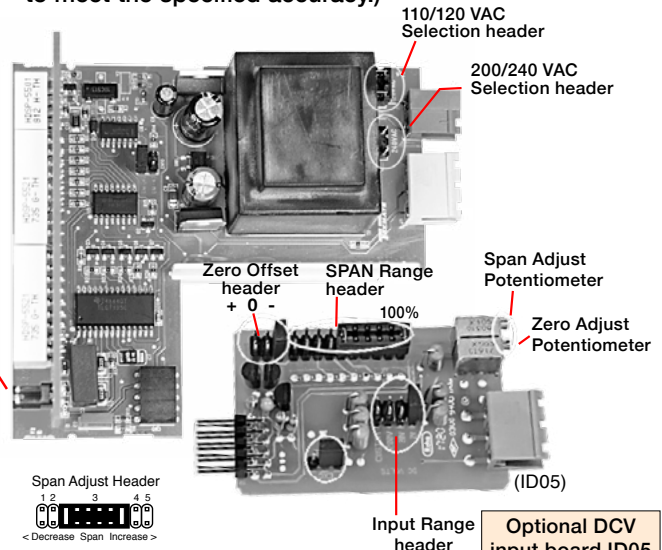

SPAN Adjust Header position	1	2	3	4	5
SPAN Pot %	10%	10%	10%	10%	10%
Signal Span %	20%	40%	60%	80%	100%

Optional DCV input board ID05 with Zero Adjust Potentiometer

Connector Pinouts

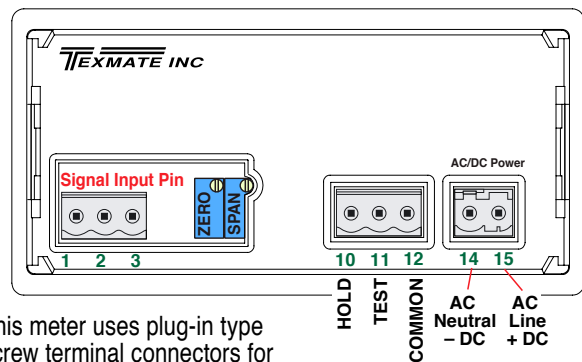

This meter uses plug-in type screw terminal connectors for all connections.

Connectors

This meter uses plug-in type screw terminal connectors for all input and output connections. The power supply connections (pins 14 and 15) have a unique plug and socket outline to prevent cross connection. The main board uses standard right-angled connectors.

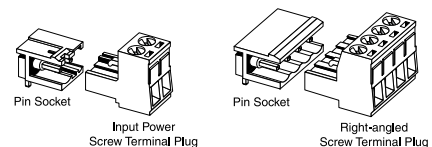

WARNING: AC and DC input signals and power supply voltages can be hazardous. Do Not connect live wires to screw terminal plugs, and do not insert, remove or handle screw terminal plugs with live wires connected.

UM Case Dimensions and Panel Cutouts

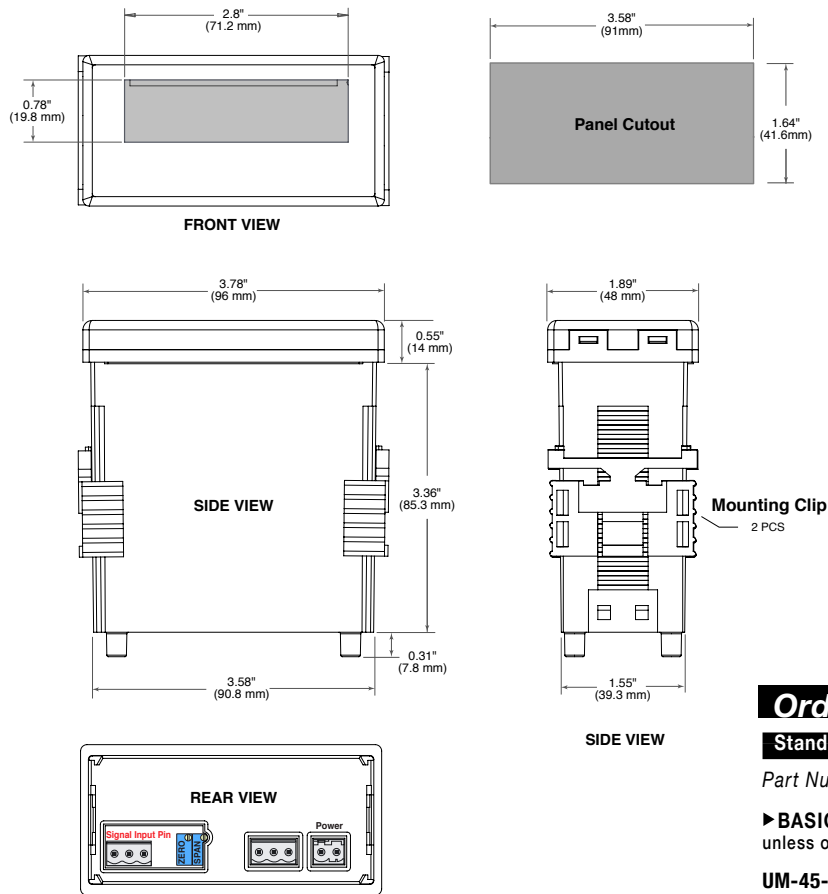

Clear Lockable Water-proof Cover

The clear lockable cover is designed to be dust and waterproof to NEMA-4X, IP65 standards. The assembly consists of a base and a cover with a cam hinge and key-lock fastening mechanism. An O-ring, or neoprene gasket forms a seal between the base and the panel. The cam hinge prevents the cover from closing when opened until pushed closed. The cover has a tapered recess that, when closed, forms a seal with a tapered spigot on the base. A key-lock employs a cam locking device to force the spigot into the recess, ensuring seal integrity. A safety catch keeps the cover closed even when the key is removed, and the keyhole can be used to attach a safety seal clip, preventing unauthorized opening.

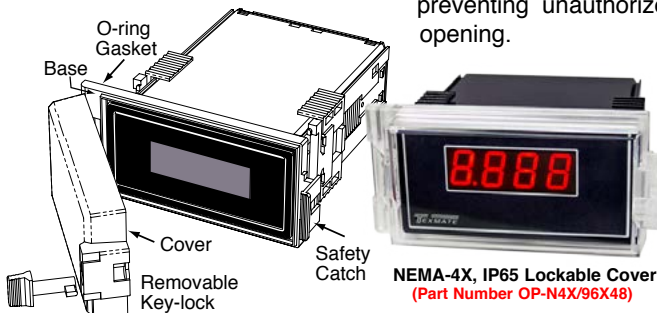

NEMA-4X, IP65 Lockable Cover
(Part Number OP-N4X/96X48)

Warranty and User's Responsibility

WARRANTY

Texmate warrants that its products are free from defects in material and workmanship under normal use and service for a period of one year from date of shipment. Texmate's obligations under this warranty are limited to replacement or repair, at its option, at its factory, of any of the products which shall, within the applicable period after shipment, be returned to Texmate's facility, transportation charges pre-paid, and which are, after examination, disclosed to the satisfaction of Texmate to be thus defective. The warranty shall not apply to any equipment which shall have been repaired or altered, except by Texmate, or which shall have been subjected to misuse, negligence, or accident. In no case shall Texmate's liability exceed the original purchase price. The aforementioned provisions do not extend the original warranty period of any product which has been either repaired or replaced by Texmate.

USER'S RESPONSIBILITY

We are pleased to offer suggestions on the use of our various products either by way of printed matter or through direct contact with our sales/application engineering staff. However, since we have no control over the use of our products once they are shipped, **NO WARRANTY WHETHER OF MERCHANTABILITY, FITNESS FOR PURPOSE, OR OTHERWISE** is made beyond the repair, replacement, or refund of purchase price at the sole discretion of Texmate. Users shall determine the suitability of the product for the intended application before using, and the users assume all risk and liability whatsoever in connection therewith, regardless of any of our suggestions or statements as to application or construction. In no event shall Texmate's liability, in law or otherwise, be in excess of the purchase price of the product.

Texmate cannot assume responsibility for any circuitry described. No circuit patent or software licenses are implied. Texmate reserves the right to change circuitry, operating software, specifications, and prices without notice at any time.

Ordering Information

Standard Options for this Model Number

Part Number	Description
► BASIC MODEL NUMBER standard display and standard power supply unless optional versions are ordered.	
UM-45-DCV.....	DPM, $\pm 2/20/200V$ DC Header selectable (ID01)
	with 50K pot Offset option (ID05)
► DISPLAY	
DR	0.56" Red LEDs
UM-BRIGHT.....	Super bright Red LEDs, 0.56 inch high
UM-GREEN.....	Green LEDs, 0.56 inch high
► POWER SUPPLY	
PS6	100/120 or 200/240VAC 60/50Hz User selectable
PS7.....	Isolated auto-sensing AC/DC 9 to 36V DC/12 to 24V AC
PS8.....	5 VDC /200mA

Special Options and Accessories

Part Number	Description
► SPECIAL OPTIONS (Specify Inputs & Req. Reading)	
ZR.....	Range Change from Standard Range shown in BOLD
ZS.....	Custom display scaling within standard ranges

► ACCESSORIES

OP-N4X/96X48	.96x48mm clear lockable front cover NEMA 4X, splash proof
CASE.RPUM	Case: Replacement with Accessories
75-DTP2X9624	Panel cutout metal trim plate 96x48mm
ART-NRC-DEC	NRC for Artwork & set-up Custom Faceplate and/or Descriptor
ART-FS1	Produce & Install Custom Faceplate per meter - 1 color no-min
ART-FS2	Produce & Install Custom Faceplate per meter - 2 color no-min
ART-FS3	Produce & Install Custom Faceplate per meter - 3 color no-min
75-DESCRIPTOR	Clear adhesive descriptors label for face plate
93-PLUG2P-DP	Extra Screw Terminal Connector, 2 Pin Power Plug
93-PLUG2P-DR	Extra Screw Terminal Connector, 2 Pin Plug
93-PLUG3P-DR	Extra Screw Terminal Connector, 3 Pin Plug
93-PLUG4P-DR	Extra Screw Terminal Connector, 4 Pin Plug



1934 Kellogg Ave., Carlsbad, CA 92008
Tel: 1-760-598-9899 • 1-800-TEXMATE
Fax: 1-760-598-9828 • Email: orders@texmate.com

UM-45-DCV Technical Manual Copyright © 2019 Texmate Inc. All rights reserved. Published by: Texmate Inc. USA. Information in this Technical Manual is subject to change without notice due to correction or enhancement. The information described in this manual is proprietary to Texmate, Inc. and may not be copied, reproduced or transmitted, in whole or in part, in connection with the design, manufacture, or sale of apparatus, device, or private label product without the express written consent of Texmate, Inc.