

NOTES:  
 INSULATOR MATERIAL - POLYPHENYLENE SULPHIDE, UL 94V-0  
 CONTACT MATERIAL - PHOSPHOR BRONZE ALLOY  
 CONTACT PLATING - GOLD OVER NICKEL UNDERPLATE  
 MOUNTING OPTION - 04-.156 (3.96) Dia. Mounting Holes  
 CONTACT TYPE - 542-Wire Wrap .045 Sq.(1.14 Sq.) - Tail LG=.750(19.05)

| TOLERANCE<br>UNLESS OTHERWISE<br>SPECIFIED |        |
|--|--------|
| .XX  | ±.01   |
| .XXX                                       | ±.005  |
| .XXXX                                      | ±.0005 |

THIS IS A C.A.D. GENERATED DRAWING  
 DO NOT MAKE MANUAL REVISIONS TO MASTER.



| ISSUE NUMBER |   |
|--------------|---|
| ORIGINAL     | ① |

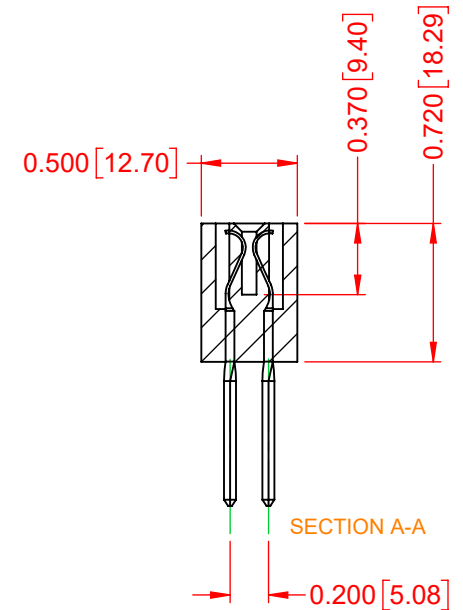
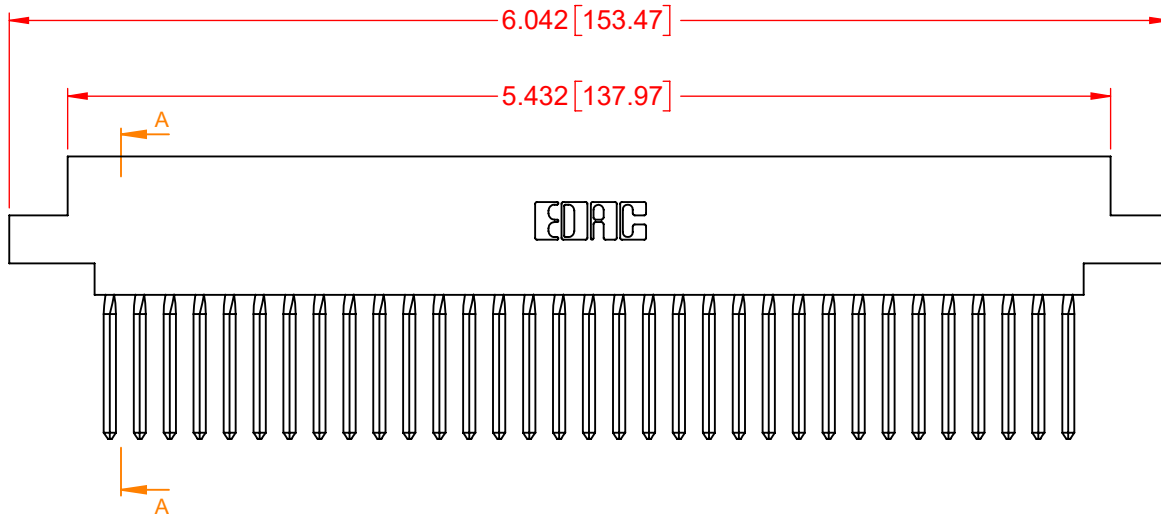
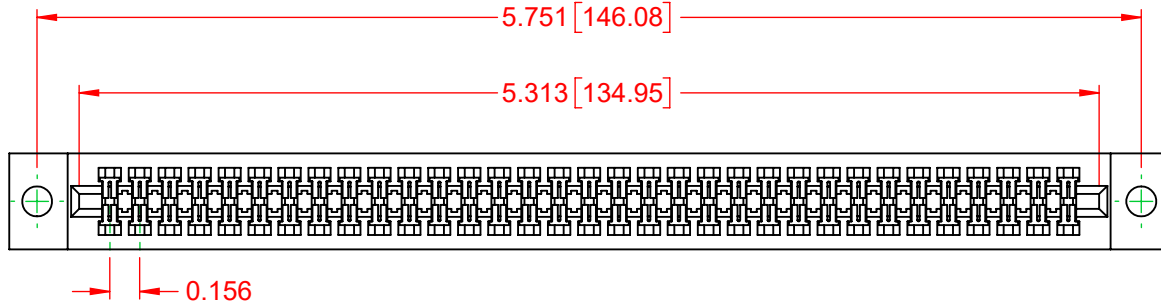

### 317 SERIES CARD EDGE CONNECTOR

|                                  |                        |
|----------------------------------|------------------------|
| ACAD REFERENCE NO.: 317 Assembly |                        |
| DRAWN: C.B                       | DATE: February 5, 2020 |
| CHECKED:                         | DATE:                  |
| SCALE: 1:1                       | SHEET 1 OF 1           |
| DRAWING NUMBER: 317-066-542-804  | ISSUE                  |
| PART NUMBER: 317-066-542-804     | 1                      |



THIS SERIES FULLY CONFORMS TO  
 THE EUROPEAN UNION DIRECTIVES  
 2011/65/EU FOR RoHS COMPLIANCY.



YOUR CONNECTION TO QUALITY & SERVICE

EDAC INC  
 TORONTO, ONTARIO  
 CANADA

THESE DRAWINGS AND SPECIFICATIONS  
 ARE THE PROPERTY OF EDAC INC., AND  
 SHALL NOT BE REPRODUCED, OR COPIED  
 OR USED AS THE BASIS FOR THE  
 MANUFACTURE OR SALE OF APPARATUS  
 WITHOUT WRITTEN PERMISSION.