



# BMD-200 Data Sheet

Version 2.1



# 1 Contents

1	Contents.....	i
2	Introduction.....	1
3	Features .....	1
4	Applications.....	1
5	Ordering Information.....	2
6	Block Diagram.....	2
7	Quick Specifications .....	3
8	Pin Descriptions - BMD-200 .....	4
8.1	Pin-out.....	4
8.2	Pin Descriptions.....	4
9	Electrical Specifications .....	4
9.1	Absolute Maximum Ratings.....	5
9.2	Operating Conditions.....	5
9.3	General Purpose I/O .....	5
9.4	Peripheral pin assignments .....	6
9.5	Debug & Programming.....	6
9.6	Clocks.....	6
9.6.1	32.768kHz Crystal (LFXO).....	6
9.6.2	32.768kHz Clock Source Comparison .....	7
10	Firmware .....	8
10.1	Factory Image .....	8
10.1.1	Firmware Version 'AA' (Deprecated).....	8
10.1.2	Firmware Version 'AB' .....	8
10.1.3	Firmware Version 'AC' .....	8
10.1.4	Firmware Version 'AD'.....	10
10.2	Module Programming and Read-Back Protection .....	10
10.3	SoftDevices .....	11
10.3.1	S110.....	11
10.3.2	S120.....	11
10.3.3	S130.....	11
10.4	MAC Address Info .....	12
11	Mechanical Data.....	13
11.1	Dimensions.....	13
11.2	Recommended PCB Land Pads.....	13
11.3	Module Marking.....	14
12	RF Design Notes.....	15
12.1	Recommended RF Layout & Ground Plane.....	15
12.2	Mechanical Enclosure .....	15
12.3	Antenna Patterns.....	16
12.3.1	S33 Smith Chart.....	16
12.3.2	3D Radiation Pattern.....	16
12.3.3	XY-plane.....	17
12.3.4	XZ-plane.....	18
12.3.5	YZ-plane.....	18
13	BMD-200-EVAL Development Kit.....	19
14	Bluetooth Qualification.....	19
15	Regulatory Agency Approvals .....	20
15.1	United States (FCC):.....	20

15.1.1	Labeling & User Information Requirements .....	20
15.1.2	RF Exposure .....	20
15.2	Canada (IC).....	21
15.2.1	Labeling & User Information Requirements .....	21
15.2.2	RF Exposure .....	23
15.3	Europe (CE) .....	23
15.3.1	Labeling & User Information Requirements .....	23
15.4	Japan (MIC) .....	23
15.5	Environmental .....	24
15.5.1	RoHS .....	24
15.5.2	REACH.....	24
15.5.3	California Proposition 65 (P65).....	24
16	Solder Reflow Temperature-Time Profile.....	25
16.1	Moisture Sensitivity Level.....	25
17	Packaging and Labeling .....	25
17.1	Carrier Tape Dimensions .....	25
17.2	Reel Packaging.....	25
17.3	Packaging Label .....	26
18	Cautions .....	27
19	Life Support and other High-Risk Use Warning .....	27
20	Related Documents.....	28
21	Contact Information .....	28
22	List of Tables .....	2
23	List of Figures.....	2
24	Document History .....	3

## 2 Introduction

The BMD-200 from Rigado is a powerful, highly flexible Bluetooth Smart module based on the nRF51822 SoC from Nordic Semiconductor. With an ARM® Cortex™ M0 CPU, embedded 2.4GHz transceiver, and on-module chip antenna, the BMD-200 provides a complete RF solution with no additional RF design, allowing faster time to market. The BMD-200 provides full use of the nRF51822's on-chip peripherals, allowing for a wide range of applications without the need for an external host microcontroller; simplifying designs and reducing BOM costs. With an internal DC-DC converter and a voltage supply range of 1.8V to 3.6V, the BMD-200 can be powered directly from a coin cell or two AAA batteries with ultra-low power consumption.

## 3 Features

- Based on the Nordic nRF51822 SoC
- Complete RF solution with integrated chip antenna
- Integrated DC-DC converter
- No external components required
- ARM® Cortex™-M0 32-bit processor
- Serial Wire Debug (SWD)
- S100 series SoftDevice ready
- Over-the-Air (OTA) firmware updates
- 256 kB embedded flash program memory
- 32/16 kB RAM
- FCC ID: 2AA9B03
- IC: 12208A-01
- One 32-bit and two 16-bit timers with counter mode
- 15 General Purpose I/O Pins
- 8/9/10 bit ADC - 8 configurable channels
- SPI Master/Slave (4 Mbps/2 Mbps)
- Low power comparator
- Temperature sensor
- Two-wire Master (I2C compatible)
- UART (w/ CTS/RTS)
- CPU independent Programmable Peripheral Interconnect (PPI)
- Quadrature Decoder (QDEC)
- AES HW encryption
- Real Timer Counter (RTC)
- Dimensions: 17x17x2.9mm

## 4 Applications

- Beacons - iBeacon™, Eddystone, AltBeacon, etc.
- Low-Power Sensors
- Fitness devices
- Wearables
- Climate Control
- Lighting
- Safety and Security
- Home Appliances
- Access Control
- Internet of Things
- Home Health Care
- Advanced Remote Controls
- Smart Energy Management
- Low-Power Sensor Networks
- Interactive Entertainment
- Key Fobs
- Environmental Monitoring
- Hotel Automation
- Office Automation

## 5 Ordering Information

*NOTE: As of January 2019, the BMD-200 modules and evaluation boards are Not Recommended for New Designs (NRND). Please see Rigado's longevity statement on [www.rigado.com](http://www.rigado.com) for additional details.*

Part Number	Description
BMD-200-A-R	BMD-200 module, 16kB, Rev A, Tape & Reel, 1000-piece multiples
BMD-200-B-R	BMD-200 module, 32kB, Rev B, Tape & Reel, 1000-piece multiples
BMD-200-EVAL-S	BMD-200 Evaluation Kit with SEGGER J-Link-OB programmer
BMD-200-EVAL-M	BMD-200 Evaluation Kit with mbed programmer

Table 1 - Ordering Information

## 6 Block Diagram

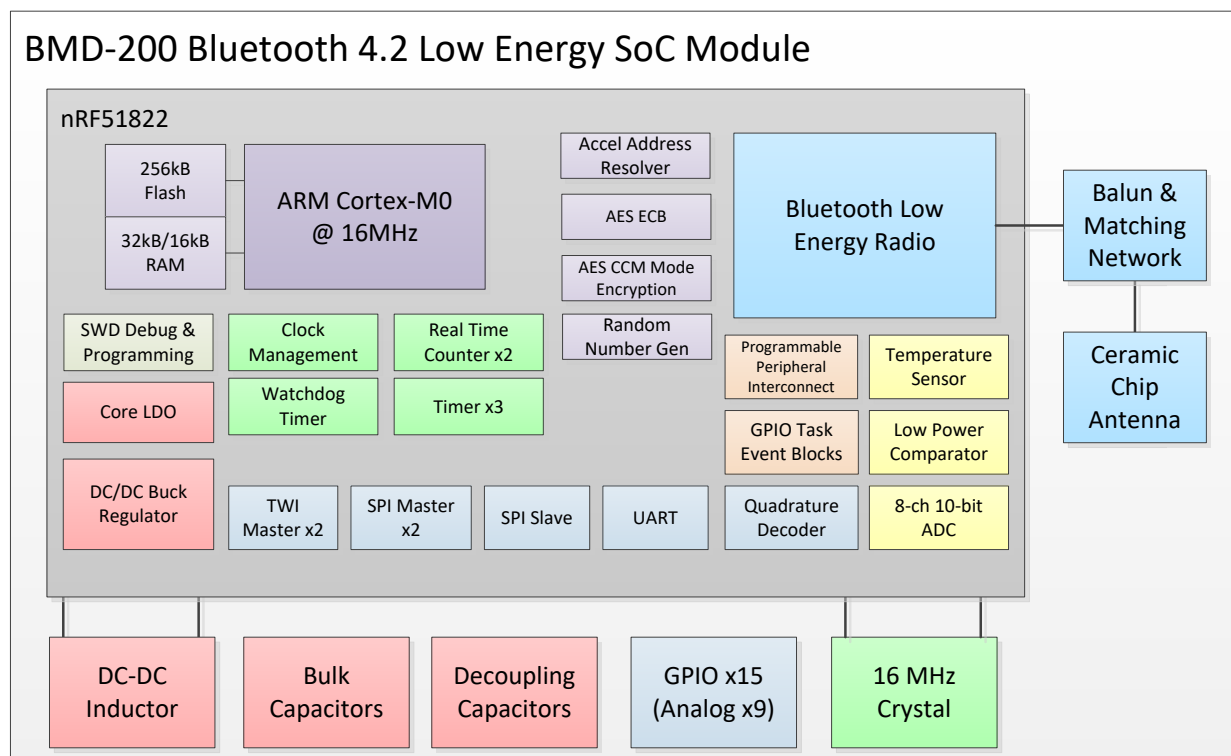

Figure 1 - Block Diagram

## 7 Quick Specifications

Bluetooth							
Version	4.2 Low Energy, Simultaneous Peripheral & Central (SoftDevice S130)						
Security	AES-128						
LE connections	3 Central & 1 Peripheral (S130)						
Radio							
Frequency	2.402GHz to 2.480GHz						
Modulations	GFSK at 250 kbps, 1 Mbps (BLE), 2 Mbps data rates						
Transmit power	+4 dBm						
Receiver sensitivity	-93 dBm (BLE mode)						
Antenna	Integrated ceramic chip						
Current Consumption							
TX only @ +4 dBm, 0 dBm, -4 dBm (w/DCDC)	11.8 mA, 8.0 mA, 6.3 mA						
RX only @ 1 Mbps (w/DCDC)	9.7 mA						
CPU @ 16MHz from flash, from RAM	4.1 mA, 2.4 mA						
System Off, additional per 8k RAM retention	0.6 $\mu$ A, 0.6 $\mu$ A						
Dimensions							
BMD-200	<table border="1"> <tr> <td>Length</td> <td>17.0 mm</td> </tr> <tr> <td>Width</td> <td>17.0 mm</td> </tr> <tr> <td>Height</td> <td>2.9 mm</td> </tr> </table>	Length	17.0 mm	Width	17.0 mm	Height	2.9 mm
Length	17.0 mm						
Width	17.0 mm						
Height	2.9 mm						
Hardware							
Interfaces	SPI Master/Slave, UART, Two-Wire Master, GPIO						
Power supply	1.8V to 3.6V						
Temperature Range	-25 to +75°C (-40 to +85°C with reduced specifications, 16kB only)						
Certifications							
USA (FCC)	FCC part 15 modular certification FCC ID: 2AA9B03						
Canada (IC)	Industry Canada RSS-210 modular certification IC: 12208A-01						
Europe (CE)	EN 60950-1: A2:2013 3.1 (a): Health and Safety of the User EN 301 489-1 V2.1.1 & 3.1 (b): Electromagnetic Compatibility EN 301 489-17 V3.1.1 EN 300 328 V2.1.1 3.2: Effective use of spectrum allocated						
Japan (MIC)	Ministry of Internal Affairs and Communications (MIC) of Japan pursuant to the Radio Act of Japan MIC: 001-A06997						
Export							
BMD-200	ECCN: 5A992.C, Exception 740.17(b)(1) HTS: 8473.30.1180						
Nordic Semiconductor nRF52810							
Additional details	<a href="#">nRF51822 Product Specification</a> <a href="#">Software Development Kit</a>						

Table 2 - Quick Specifications

## 8 Pin Descriptions - BMD-200

### 8.1 Pin-out

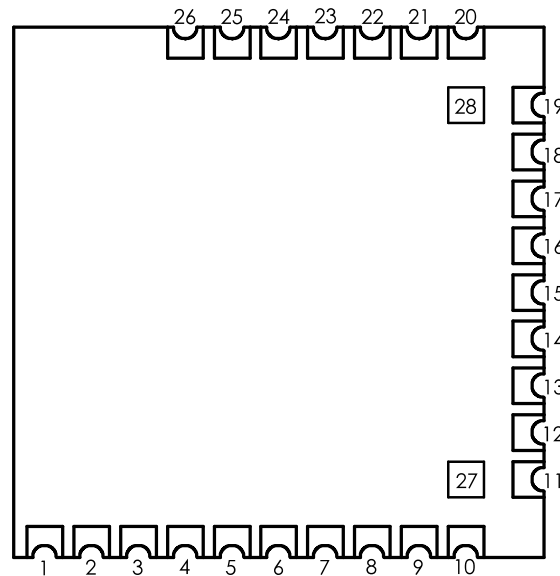

Figure 2 - BMD-200 Pin-out

### 8.2 Pin Descriptions

Pin	Name	Direction	Description
5	P0.24	In/Out	GPIO
6	P0.25	In/Out	GPIO
8	P0.26	In/Out	GPIO/AIN0/XTAL2 (32.768kHz)
9	P0.27	In/Out	GPIO/AIN1/XTAL1 (32.768kHz)
11	P0.00	In/Out	GPIO/AREF0
12	P0.01	In/Out	GPIO/AIN2
13	P0.02	In/Out	GPIO/AIN3
14	P0.03	In/Out	GPIO/AIN4
15	P0.04	In/Out	GPIO/AIN5
16	P0.05	In/Out	GPIO/AIN6
17	P0.06	In/Out	GPIO/AIN7/AREF1
20	P0.08	In/Out	GPIO
21	P0.09	In/Out	GPIO
22	P0.10	In/Out	GPIO
23	P0.11	In/Out	GPIO
24	SWDIO	In/Out	SWD IO/ $\overline{\text{RESET}}$
25	SWCLK	In	SWD Clock
18	VCC	Power	+1.8V to +3.6V1
1, 2, 3, 4, 7, 10, 19, 26, (27, 28 opt.)	GND	Power	Electrical Ground

Note 1: An internal 4.7 $\mu$ F bulk capacitor is included on the module. However, it is good design practice to add additional bulk capacitance as required for your application, i.e. those with heavy GPIO usage and/or current draw.

Table 3 - Pin Descriptions

## 9 Electrical Specifications

## 9.1 Absolute Maximum Ratings

Symbol	Parameter	Min.	Max.	Unit
V <sub>CC_MAX</sub>	Voltage on supply pin	-0.3	3.9	V
V <sub>IO_MAX</sub>	Voltage on GPIO pins	-0.3	VCC + 0.3	V
T <sub>S</sub>	Storage Temperature Range	-40	125	°C

Table 4 - Absolute Maximum Ratings

## 9.2 Operating Conditions

Symbol	Parameter	Min.	Typ.	Max.	Unit
V <sub>CC</sub>	Operating supply voltage	1.8	3.0	3.6	V
T <sub>R_VCC</sub>	Supply rise time (0V to 1.8V)	-	-	60	ms
T <sub>A</sub>	Operating Ambient Temperature Range	-25	25	75	°C
T <sub>Aext</sub>	Extended Operating Temperature Range <sup>1,2</sup>	-40	25	85	°C

Note 1: Valid only for BMD-200-A-R (16kB)

Note 2: VCC range reduced to 1.9V to 3.6V. Some degradation in RF performance. See Nordic Semiconductor's 'nRF51822 specification for Industrial Temperature Range' Addendum for full details (QFAA variant).

Table 5 - Operating Conditions

## 9.3 General Purpose I/O

The general purpose I/O is organized as one port enabling access and control of the 32 available GPIO pins through one port. Each GPIO can be accessed individually with the following user configurable features:

- Input/output direction
- Output drive strength
- Internal pull-up and pull-down resistors
- Wake-up from high- or low-level triggers on all pins
- Trigger interrupt on all pins
- All pins can be used by the PPI task/event system; the maximum number of pins that can be interfaced through the PPI at the same time is limited by the number of GPIOTE channels
- All pins can be individually configured to carry serial interface or quadrature demodulator signals

Symbol	Parameter	Min.	Typ.	Max.	Unit
V <sub>IH</sub>	Input High Voltage	0.7 x VCC	-	VCC	V
V <sub>IL</sub>	Input Low Voltage	VSS	-	0.3 x VCC	V
V <sub>OH</sub>	Output High Voltage	VCC – 0.3	-	VCC	V
V <sub>OL</sub>	Output Low Voltage	VSS	-	0.3	V
R <sub>PU</sub>	Pull-up Resistance	11	13	16	kΩ



RPD	Pull-down Resistance	11	13	16	kΩ
Note: GPIO have a standard drive strength of 0.5 mA, and a high drive strength of 5 mA. Maximum number of high drive strength pins is 3.					

Table 6 - GPIO

## 9.4 Peripheral pin assignments

The various peripherals within the BMD-200 may be assigned to nearly any of the GPIO pins through the application. Note that certain peripherals are assigned to particular pins, such the analog inputs.

## 9.5 Debug & Programming

The BMD-200 supports the two pin Serial Wire Debug (SWD) interface and offers flexible and powerful mechanism for non-intrusive debugging of program code. Breakpoints, single stepping, and instruction trace capture of code execution flow are part of this support.

## 9.6 Clocks

The BMD-200 requires two clocks, a high frequency clock and a low frequency clock.

The high frequency clock is provided on-module by a high-accuracy 16MHz crystal as required by the nRF51822 for radio operation.

The low frequency clock can be provided internally by an RC oscillator or synthesized from the fast clock, or externally by a 32.768kHz crystal. An external crystal provides the lowest power consumption and greatest accuracy. Using the internal RC oscillator with calibration provides acceptable performance for BLE applications at a reduced cost and slight increase in power consumption. Note: the ANT protocol requires the use of an external crystal.

### 9.6.1 32.768kHz Crystal (LFXO)

Symbol	Parameter	Typ.	Max.	Unit
f <sub>nom</sub>	Crystal frequency	32.768	-	kHz
F <sub>tol, BLE</sub>	Frequency tolerance, Bluetooth low energy applications.	±250	-	ppm
C <sub>l</sub>	Load Capacitance	-	12.5	pF
C <sub>o</sub>	Shunt Capacitance	-	2	pF
R <sub>s</sub>	Equivalent series resistance	50	80	kΩ
C <sub>pin</sub>	Input Capacitance on XTAL1 & XTAL2	5	-	pF

Table 7 - 32.768kHz Crystal (LFXO)

## 9.6.2 32.768kHz Clock Source Comparison

Symbol	Parameter	Min.	Typ.	Max.	Unit
I <sub>LFXO</sub>	Current for 32.768kHz Crystal Oscillator	-	0.4	1.0	μA
I <sub>LFRC</sub>	Current for 32.768kHz RC Oscillator	-	0.8	1.1	μA
I <sub>LFSYNT</sub>	Current for 32.768kHz Synthesized Oscillator	-	15	-	μA
f <sub>TOL_LFXO_BLE</sub>	Frequency Tolerance, 32.768kHz Crystal Oscillator (BLE Stack) <sup>1</sup>	-	-	±250	ppm
f <sub>TOL_LFXO_ANT</sub>	Frequency Tolerance, 32.768kHz Crystal Oscillator (ANT Stack) <sup>1</sup>	-	-	±50	ppm
f <sub>TOL_LFRC</sub>	Frequency Tolerance, 32.768kHz RC Oscillator	-	±2	-	%
f <sub>TOL_CAL_LFRC</sub>	Frequency tolerance, 32.768kHz RC after calibration	-	-	±250	ppm
f <sub>TOL_LFSYNT</sub>	Frequency Tolerance, 32.768kHz Synthesized Oscillator	-	±34	-	ppm

Note 1: f<sub>TOL\_LFXO\_BLE</sub> and f<sub>TOL\_LFXO\_ANT</sub> are the maximum allowed for BLE and ANT applications. Actual tolerance depends on the crystal used.

Table 8 - 32.768kHz Clock Source Comparison

## 10 Firmware

Rigado recommends that projects for the BMD-200 utilize [Nordic Semiconductor's SDK, DFU, examples](#) and the nRF51822 tools for any new development. This will allow access to the very latest Bluetooth support from Nordic and provide an ongoing path as new features are released.

NOTICE: For legacy applications, Rigado now provides source code through our GitHub repositories for RigDFU, BMDware, Rigablue developer tools and mobile apps for customers to customize and extend on their own. [Please refer to this article at Rigado's Help Center.](#)

### 10.1 Factory Image

The factory programmed firmware version is indicated on the label. *Programming of the factory image is maintained solely for legacy applications. New development should use the latest [Nordic Semiconductor SDK and examples](#).*

#### 10.1.1 Firmware Version 'AA' (Deprecated)

- Rigado RigDFU (non-encrypted)
- Nordic S110 SoftDevice v6.0.0
- Factory Test

Modules can be programmed with customer code after a full-chip erase via the SWD interface.

Note: A full chip erase will clear the Rigado assigned MAC address from memory; see section 8.3 "MAC Address Info" on how to retain it.

#### 10.1.2 Firmware Version 'AB'

- Rigado RigDFU v3.0.0
- Nordic S110 SoftDevice v8.0.0
- BMDware v2.0.5

Modules can be programmed with customer code after a full-chip erase via the SWD interface.

Note: A full chip erase will clear the Rigado assigned MAC address from memory; see section 8.3 "MAC Address Info" on how to retain it.

#### 10.1.3 Firmware Version 'AC'

- Rigado RigDFU v3.1.0
- Nordic S110 SoftDevice v8.0.0
- BMDware v3.0.0

Modules can be programmed with customer code after a full-chip erase via the SWD interface.

Note: A full chip erase will clear the Rigado assigned MAC address from memory; see section 8.3 "MAC Address Info" on how to retain it.

NOTE: BMDware v3.0.0 has a known issue where BLE-UART Bridge will drop 0x0A & 0x0D values when transferring from the UART to BLE. Please contact Rigado ([modules@rigado.com](mailto:modules@rigado.com)) for an updated version or an older version.



### 10.1.4 Firmware Version 'AD'

- Rigado RigDFU v3.2.1
- Nordic S110 SoftDevice v8.0.0
- BMDware v3.1.1

Modules can be programmed with customer code after a full-chip erase via the SWD interface.

Note: A full chip erase will clear the Rigado assigned MAC address from memory; see section 8.3 “MAC Address Info” on how to retain it.

## 10.2 Module Programming and Read-Back Protection

For legacy applications, RigDFU allows for UART and OTA updates to RigDFU, the SoftDevice and application firmware.

In order to utilize the SWD port on on BMD-200 modules, the nRF51822 must be erased and recovered. Without this step, the module will not be recognized by most programmers. This is accomplished through *nrfjprog*, which is provided with the Nordic Semiconductor command line utilities:

```
nrfjprog -f nrf51 --recover
```

A full chip erase is performed, so all components will need to be re-loaded (Bootloader, SoftDevice and application Firmware).

The BMD-200 modules may be restored to the factory firmware versions noted above with the utilities available on GitHub at:

<https://github.com/rigado/programmers>.

## 10.3 SoftDevices

Nordic Semiconductor protocol stacks are known as SoftDevices. SoftDevices are pre-compiled, pre-linked binary files. SoftDevices can be programmed in nRF51 series SoCs and are downloadable from the Nordic web. The BMD-200 with the nRF51822 SoC supports the S110, S120, and S130 SoftDevices.

### 10.3.1 S110

The S110 SoftDevice is a Bluetooth® low energy (BLE) Peripheral/Broadcaster protocol stack solution. It integrates a Bluetooth low energy controller and host and provides a full and flexible API for building Bluetooth low energy System on Chip (SoC) solutions.

### 10.3.2 S120

The S120 SoftDevice is a Bluetooth® low energy (BLE) Central protocol stack solution supporting up to eight simultaneous Central role connections. It integrates a Bluetooth low energy controller and host and provides a full and flexible API for building Bluetooth low energy System on Chip (SoC) solutions.

### 10.3.3 S130

S130 SoftDevice is a Bluetooth® Smart concurrent multi-link protocol stack solution supporting simultaneous Central/Peripheral/Broadcaster/Observer role connections. It integrates a Bluetooth Smart controller and host and provides a full and flexible API for building Bluetooth Smart System on Chip (SoC) solutions.

## 10.4 MAC Address Info

The BMD-200 modules come preprogrammed with a unique MAC address from the factory. The MAC address is also printed on a 2D barcode on the top of the module.

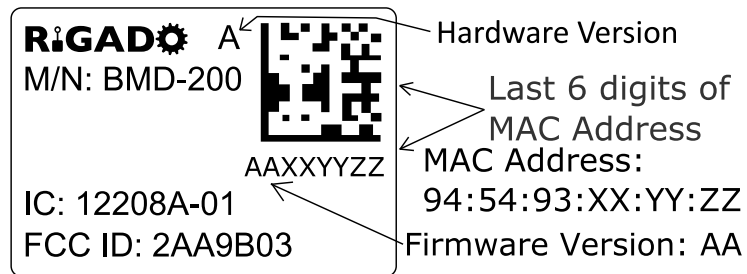

Figure 3 - MAC Address on Label

The 6-byte BLE Radio MAC address is stored in the nRF51822 UICR at `NRF_UICR_BASE+0x80` LSB first. Please read the MAC Address Provisioning application note to avoid erasing/overwriting the MAC address during programming.

### UICR Register:

`NRF_UICR + 0x80 (0x10001080): MAC_Addr [0] (0xZZ)`  
`NRF_UICR + 0x81 (0x10001081): MAC_Addr [1] (0xYY)`  
`NRF_UICR + 0x82 (0x10001082): MAC_Addr [2] (0xFF)`  
`NRF_UICR + 0x83 (0x10001083): MAC_Addr [3] (0x93)`  
`NRF_UICR + 0x84 (0x10001084): MAC_Addr [4] (0x54)`  
`NRF_UICR + 0x85 (0x10001085): MAC_Addr [5] (0x94)`

# 11 Mechanical Data

## 11.1 Dimensions

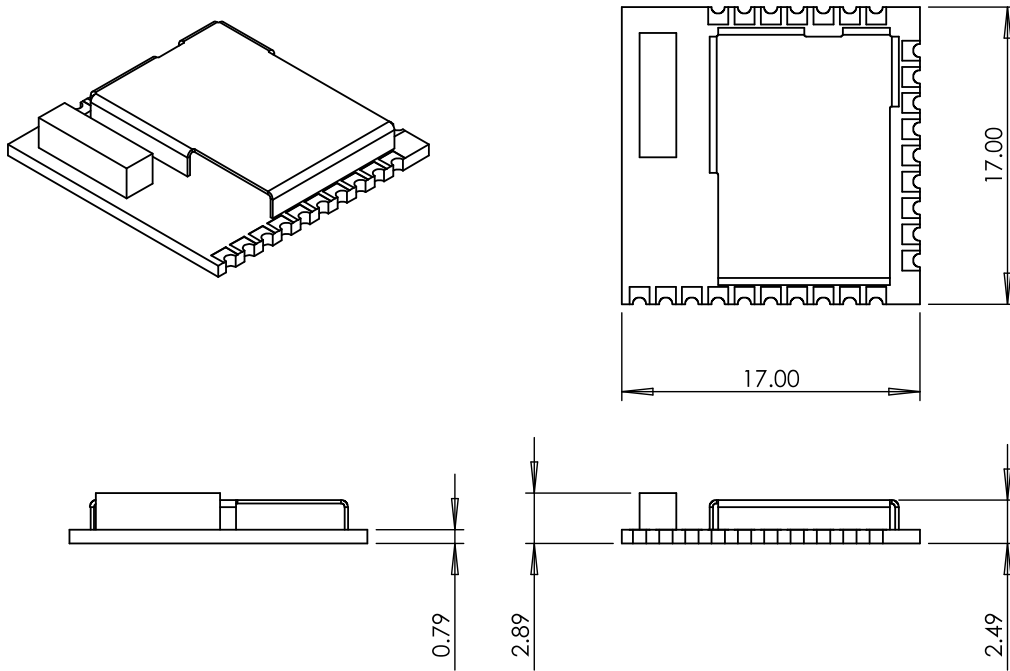

Figure 4 - Mechanical Drawing

## 11.2 Recommended PCB Land Pads

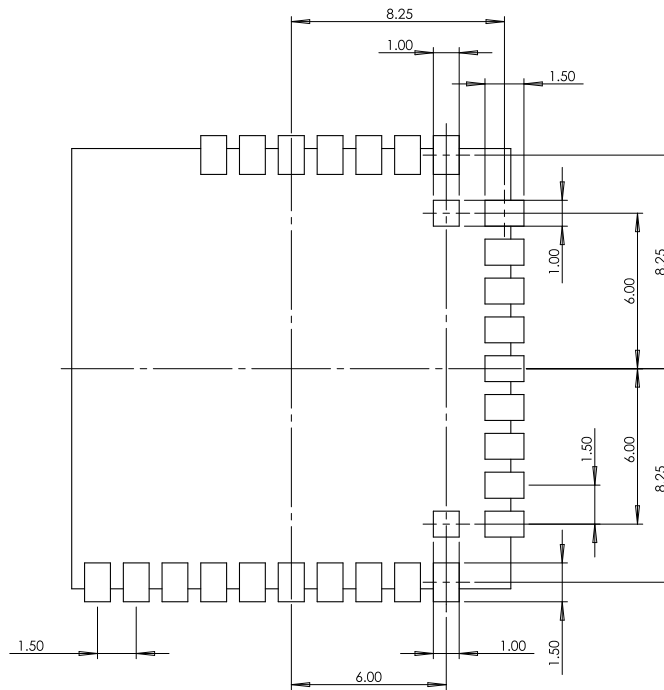

Figure 5 - Recommended PCB Land Pads



Note: The RF Keep-out area extends vertically to the board edge.

### 11.3 Module Marking

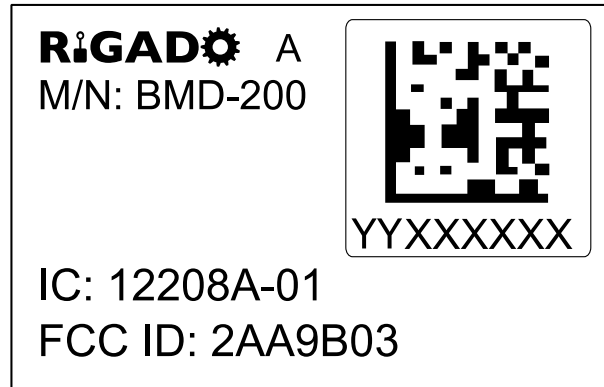

Figure 6 – Module Marking – Rev A – BMD-200-A (16kB)

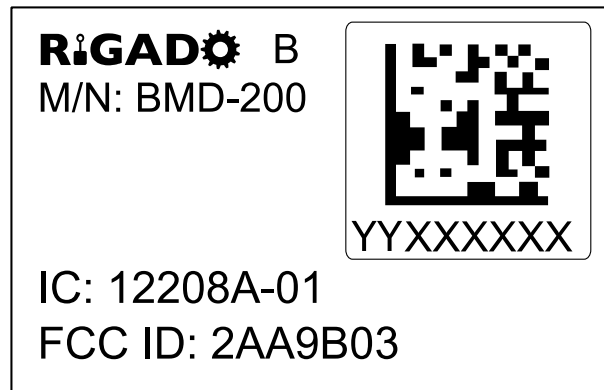

Figure 7 – Module Marking – Rev B – BMD-200-B (32kB)

## 12 RF Design Notes

### 12.1 Recommended RF Layout & Ground Plane

The integrated ceramic chip antenna requires a suitable ground plane to radiate effectively. Reducing the ground plane from that shown in figure 7 will reduce the effective radiated power.

The area under and extending out from the antenna portion of the module should be kept clear of copper and other metal. The module should be placed at the edge or, ideally, at the corner of the PCB with the antenna edge facing out.

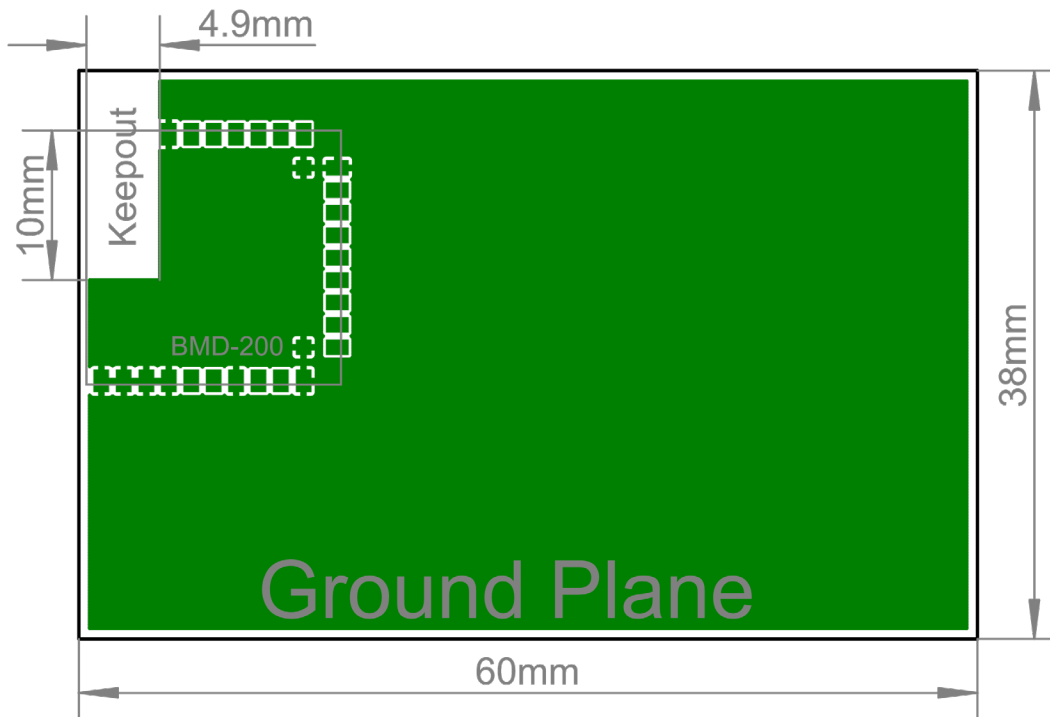

Figure 8 – Recommended RF Layout & Ground Plane

### 12.2 Mechanical Enclosure

Care should be taken when designing and placing the BMD-200 into an enclosure. Metal should be kept clear from the antenna area, both above and below. Any metal around the module can negatively impact RF performance.

The module is designed and tuned for the antenna and RF components to be in free air. Any potting, epoxy fill, plastic over-molding, or conformal coating can negatively impact RF performance and must be evaluated by the customer.

### 12.3 Antenna Patterns

Antenna patterns are based on the BMD-200 Evaluation Kit vA with a ground plane size of 38mm x 60mm. X-Y-Z orientation is shown in Figure 9:

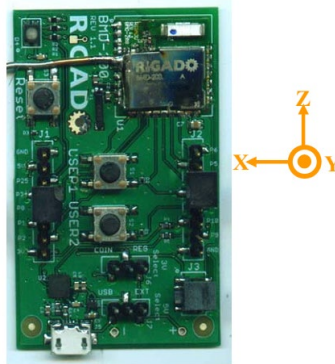

Figure 9 – BMD-200 X-Y-Z Orientation

#### 12.3.1 S33 Smith Chart

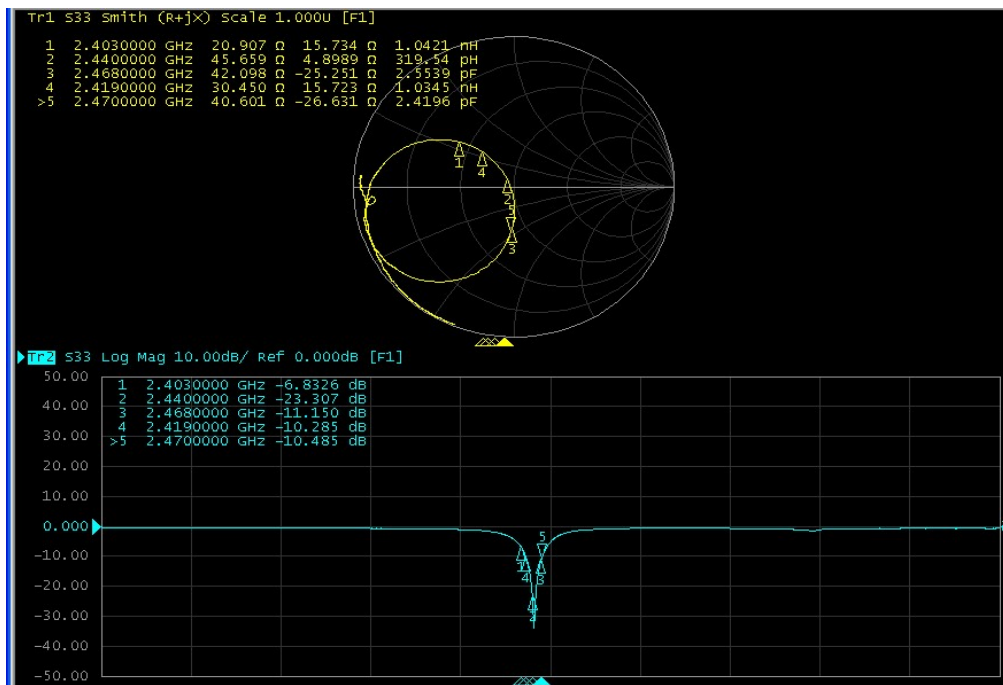

Figure 10 – S33 Antenna Smith Chart

#### 12.3.2 3D Radiation Pattern

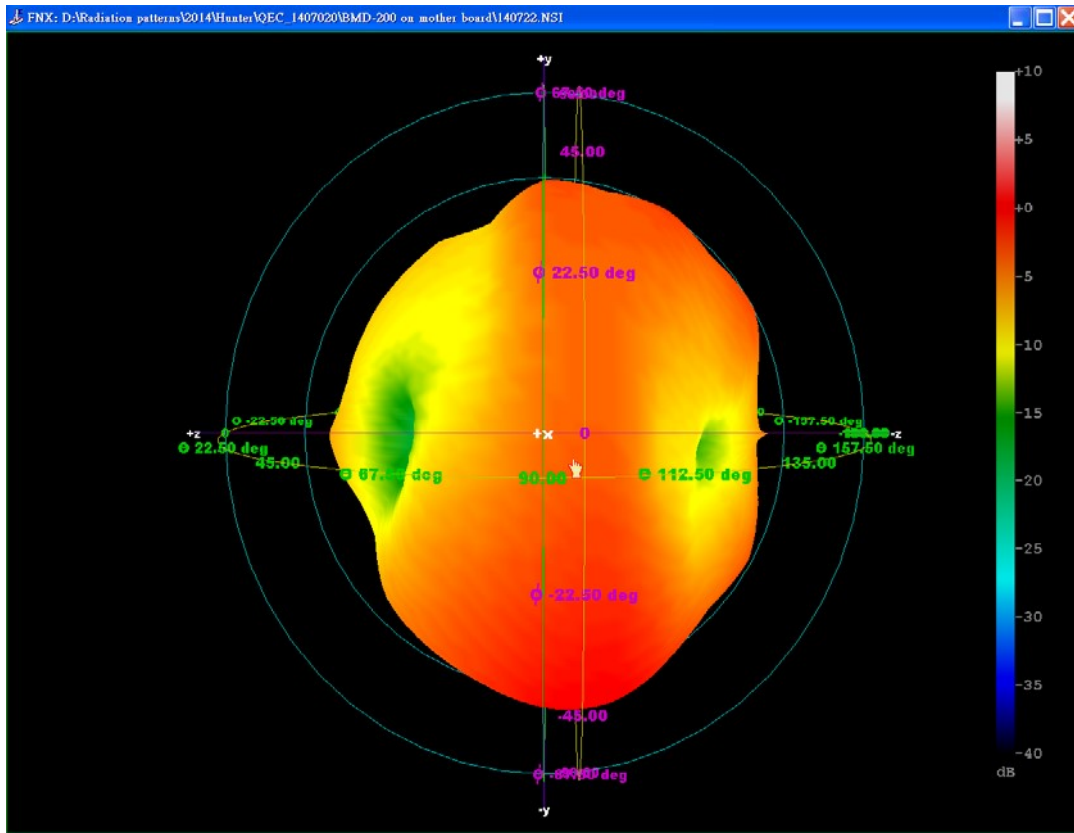
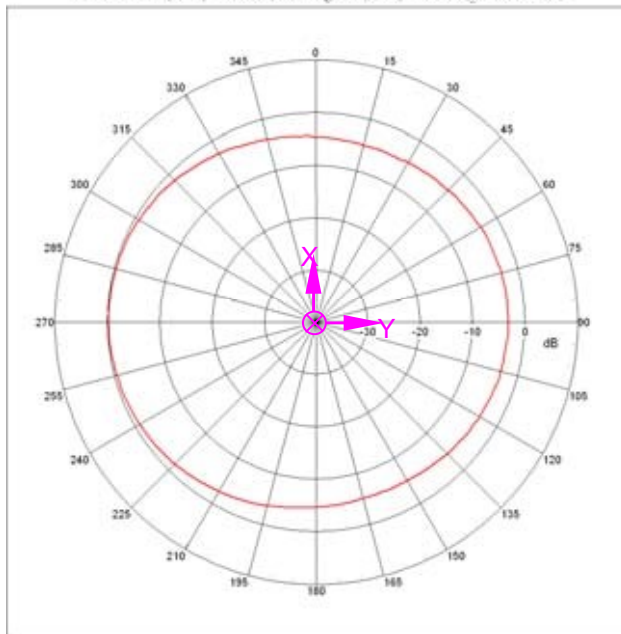

Figure 11 – 3D Radiation Pattern

### 12.3.3 XY-plane

Far-field Power Distribution(H+V) on X-Y Plane  
 Plot Peak Gain(H+V)=-0.3 dBi, Plot AvgGain(H+V)=-3.1dBi @2.44000 GHz



Unit : dBi

	Peak gain	Avg. gain
XY-plane	-0.3	-3.1

Figure 12 – XY-plane Radiation Pattern

### 12.3.4 XZ-plane

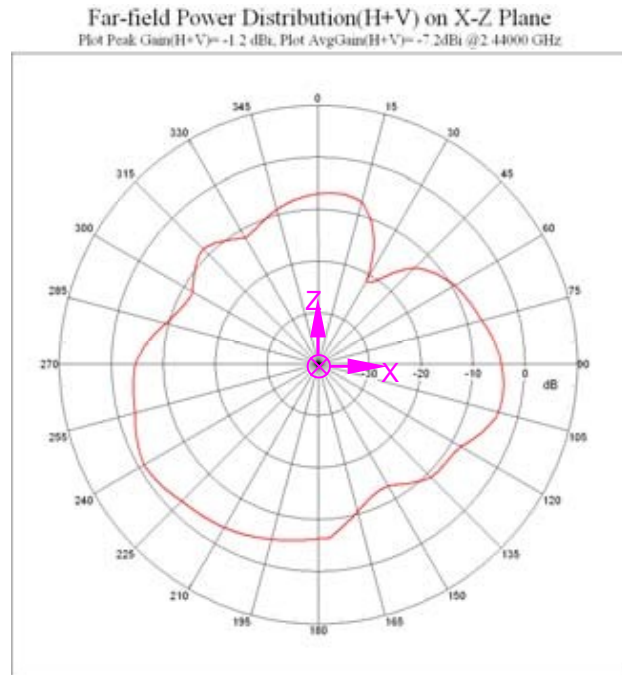

Unit : dBi

	Peak gain	Avg. gain
XZ-plane	-1.2	-7.2

Figure 13 – XZ-plane Radiation Pattern

### 12.3.5 YZ-plane

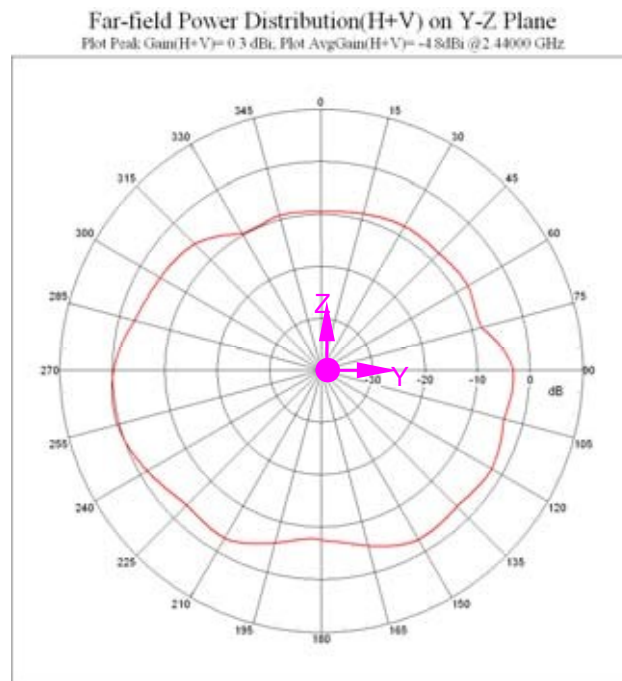

Unit : dBi

	Peak gain	Avg. gain
YZ-plane	0.3	-4.8

Figure 14 – YZ-plane Radiation Pattern

## 13 BMD-200-EVAL Development Kit

Rigado has developed full featured evaluation boards that provide a complete I/O pin out to headers, on-board programming and debug, 32.768 kHz crystal, power and virtual COM port over USB, along with a 3-axis accelerometer, ambient light sensor, RGB LED, two user buttons, and a SPI EEPROM. The evaluation boards also provide the option to be powered off of a CR2032 coin cell battery, and have a current sensor resistor and header to allow for convenient current measurements.

## 14 Bluetooth Qualification

- The Bluetooth SIG maintains the Bluetooth Specification, and ensures that products are properly tested and comply with the Bluetooth license agreements. Companies that list products with the Bluetooth SIG are required to be members of the SIG and submit the listed fees. Refer to this link for details: <https://www.bluetooth.com/develop-with-bluetooth/qualification-listing>
- The Rigado Bluetooth Low Energy modules based on Nordic Semiconductor SoCs are listed as a “Tested Component”. This allows an end-product based on a Rigado module to inherit the component listings without the need to run through all of the tests again. The end-product will often inherit several different listings, known as Qualified Design IDs (QDID), and are identified on a “Declaration of Compliance”. Refer to this Help Center article for creating a Declaration of Compliance: <https://rigado.zendesk.com/hc/en-us/articles/360002645694-Bluetooth-SIG-Launch-Studio-Product-Declaration>
- The list of Qualified Products is found here: <https://launchstudio.bluetooth.com/Listings/Search>
- The BMD-200 primarily utilizes the S130 SoftDevice
- A list of current QDIDs used by Rigado is maintained at the [Rigado Help Center](#)

## 15 Regulatory Agency Approvals

### 15.1 United States (FCC):

Rigado's modules have received Federal Communications Commission (FCC) CFR47 Telecommunications, Part 15 Subpart C "Intentional Radiators" modular approval in accordance with Part 15.212 Modular Transmitter approval. Modular approval allows the end user to integrate the module into a finished product without obtaining subsequent and separate FCC approvals for intentional radiation, provided no changes or modifications are made to the module circuitry. Changes or modifications could void the user's authority to operate the equipment. The end user must comply with all of the instructions provided by the Grantee, which indicate installation and/or operating conditions necessary for compliance.

The finished product is required to comply with all applicable FCC equipment authorizations regulations, requirements and equipment functions not associated with the transmitter module portion. For example, compliance must be demonstrated to regulations for other transmitter components within the host product; to requirements for unintentional radiators (Part 15 Subpart B "Unintentional Radiators"), such as digital devices, computer peripherals, radio receivers, etc.; and to additional authorization requirements for the non-transmitter functions on the transmitter module (i.e., Verification, or Declaration of Conformity) (e.g., transmitter modules may also contain digital logic functions) as appropriate.

**Caution! The OEM is still responsible for verifying end-product compliance with FCC Part 15, subpart B limits for unintentional radiators through an accredited test facility.**

#### 15.1.1 Labeling & User Information Requirements

**The BMD-200 is assigned the FCC ID number: 2AA9B03**

If the FCC ID is not visible when the module is installed inside another device, then the outside of the finished product into which the module is installed must also display a label referring to the enclosed module. This exterior label can use the following or similar wording:

Contains FCC ID: 2AA9B03

In addition to marking the product with the appropriate FCC ID, the end-product user manual may also require specific information based on the digital device classification. Refer to the [FCC Rules, Title 47, Subchapter A, Part 15, Subpart B, Chapter §15.105](#) for specific wording of the notices.

#### 15.1.2 RF Exposure

All transmitters regulated by FCC must comply with RF exposure requirements. [KDB 447498 General RF Exposure Guidance](#) provides guidance in determining whether proposed or existing transmitting facilities, operations or devices comply with limits for human exposure to Radio Frequency (RF) fields adopted by the Federal Communications Commission (FCC).

This module is approved for installation into mobile and/or portable host platforms and must not be co-located or operating in conjunction with any other antenna or transmitter except in accordance with FCC multi-transmitter guidelines. End users

must be provided with transmitter operating conditions for satisfying RF Exposure compliance.

## 15.2 Canada (IC)

Rigado's modules have been certified for use in Canada under Industry Canada (IC) Radio Standards Specification (RSS) RSS-210 and RSSGen. Modular approval permits the installation of a module in a host device without the need to recertify the device.

### 15.2.1 Labeling & User Information Requirements

#### **The BMD-200 is assigned the IC ID number: 12208A-01**

Labeling Requirements for the Host Device (from Section 3.2.1, RSS-Gen, Issue 3, December 2010): The host device shall be properly labeled to identify the module within the host device. The Industry Canada certification label of a module shall be clearly visible at all times when installed in the host device, otherwise the host device must be labeled to display the Industry Canada certification number of the module, preceded by the words "Contains transmitter module", or the word "Contains", or similar wording expressing the same meaning, as follows:

Contains transmitter module IC: 12208A-01

User Manual Notice for License-Exempt Radio Apparatus (from Section 7.1.3 RSS-Gen, Issue 3, December 2010): User manuals for license-exempt radio apparatus shall contain the following or equivalent notice in a conspicuous location in the user manual or alternatively on the device or both:

This device complies with Industry Canada license exempt RSS standard(s). Operation is subject to the following two conditions: (1) this device may not cause interference, and (2) this device must accept any interference, including interference that may cause undesired operation of the device.

Le présent appareil est conforme aux CNR d'Industrie Canada applicables aux appareils radio exempts de licence. L'exploitation est autorisée aux deux conditions suivantes: (1) l'appareil ne doit pas produire de brouillage, et (2) l'utilisateur de l'appareil doit accepter tout brouillage radioélectrique subi, même si le brouillage est susceptible d'en compromettre le fonctionnement.

Transmitter Antenna (from Section 7.1.2 RSS-Gen, Issue 3, December 2010): User manuals for transmitters shall display the following notice in a conspicuous location:

Under Industry Canada regulations, this radio transmitter may only operate using an antenna of a type and maximum (or lesser) gain approved for the transmitter by Industry Canada. To reduce potential radio interference to other users, the antenna type and its gain should be so chosen that the equivalent isotropically radiated power (e.i.r.p.) is not more than that necessary for successful communication.

Conformément à la réglementation d'Industrie Canada, le présent émetteur radio peut fonctionner avec une antenne d'un type et d'un gain maximal (ou inférieur) approuvé pour l'émetteur par Industrie Canada. Dans le but de réduire les risques de brouillage radioélectrique à l'intention des autres



utilisateurs, il faut choisir le type d'antenne et son gain de sorte que la puissance isotrope rayonnée équivalente (p.i.r.e.) ne dépasse pas l'intensité nécessaire à l'établissement d'une communication satisfaisante.

## 15.2.2 RF Exposure

All transmitters regulated by IC must comply with RF exposure requirements listed in RSS-102 - Radio Frequency (RF) Exposure Compliance of Radiocommunication Apparatus (All Frequency Bands). This module is approved for installation into mobile and/or portable host platforms and must not be co-located or operating in conjunction with any other antenna or transmitter except in accordance with Industry Canada's multi-transmitter guidelines. End users must be provided with transmitter operating conditions for satisfying RF Exposure compliance.

## 15.3 Europe (CE)

The BMD-200 is a Radio Equipment Directive assessed radio module that is CE complaint and have been manufactured and tested with the intention of being integrated into a final product.

The BME-200 has been tested to current Radio Equipment Directives

- EN 60950-1: 2006 + A11: 2009 + A1: 2010 + A12: 2011 + A2: 2013
- ETSI EN 300 328 V 2.1.1
- ETSI EN 301 489-1 V2.1.1
- ETSI EN 301 489-17 V3.1.1

The Radio Equipment Directive - Compliance Association (RED-CA) provides guidance on modular devices at the RED-CA website:

<http://www.redca.eu/Pages/Documents%201.htm>.

### 15.3.1 Labeling & User Information Requirements

The label on the final products which contain a Rigado module must follow CE marking requirements. The "R&TTE Compliance Association Technical Guidance Note 01" provides guidance on final product CE marking.

## 15.4 Japan (MIC)

The BMD-200 module has received type certification and is labeled with its own technical conformity mark and certification number as required to conform to the technical standards regulated by the Ministry of Internal Affairs and Communications (MIC) of Japan pursuant to the Radio Act of Japan. Integration of this module into a final end-product does not require additional radio certification provided installation instructions are followed and no modifications of the module are allowed. Additional testing may be required:

- If the host product is subject to electrical appliance safety (for example, powered from an AC mains), the host product may require Product Safety Electrical Appliance and Material (PSE) testing. The integrator should contact their conformance laboratory to determine if this testing is required.
- There is a voluntary Electromagnetic Compatibility (EMC) test for the host product administered by VCCI: [http://www.vcci.jp/vcci\\_e/index.html](http://www.vcci.jp/vcci_e/index.html)

The label on the end-product which contains a BMD-200 Series module must follow the MIC marking requirements. Labeling requirements for Japan available at the Ministry of Internal Affairs and Communications (MIC) website:

<http://www.tele.soumu.go.jp/e/index.htm>.

The BMD-200 module is labeled with its assigned technical conformity mark and certification number. The end-product in which this module is being used must have an external label referring to the type certified module inside:

Contains transmitter module with certificate number:



Figure 15 – Japan MIC Mark

## 15.5 Environmental

### 15.5.1 RoHS

Rigado's modules are in compliance with Directive 2011/65/EU, 2015/863/EU of the European Parliament and the Council on the restriction of the use of certain hazardous substances in electrical and electronic equipment. The declaration may be found here: <https://go.rigado.com/RoHS-Modules>

### 15.5.2 REACH

Rigado's modules listed below do not contain the [191 SVHC \(Substance of Very High Concern\)](#), as defined by Directive EC/1907/2006 Article according to REACH Annex XVII. The compliance statement may be found here: <https://go.rigado.com/REACH-Modules>

### 15.5.3 California Proposition 65 (P65)

This product can expose you to Nickel (metallic), which is known to the State of California to cause cancer. For more information go to [www.P65Warnings.ca.gov](http://www.P65Warnings.ca.gov). Warnings are not required where the listed chemical is inaccessible to the average user of the end-product.

## 16 Solder Reflow Temperature-Time Profile

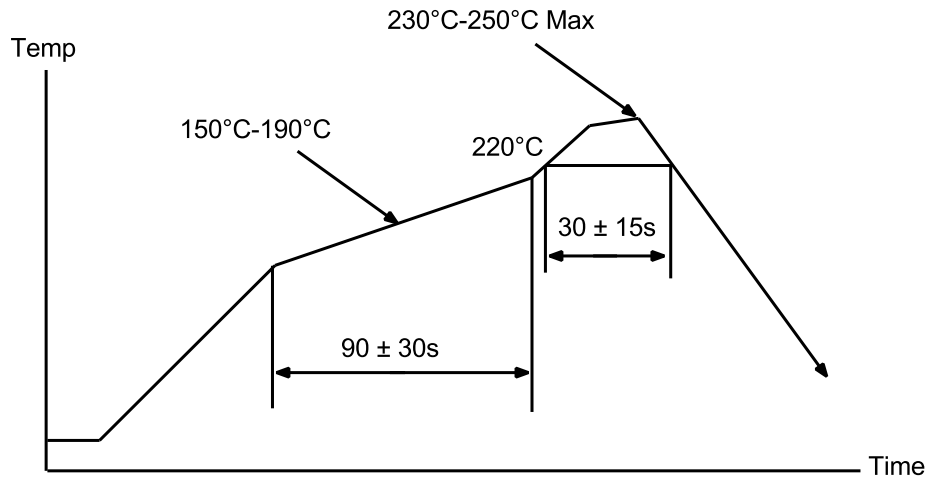

Figure 16 - Reflow Profile for Lead Free Solder

### 16.1 Moisture Sensitivity Level

The BMD-200 is rated for MSL 3, 168-hour floor life after opening.

## 17 Packaging and Labeling

### 17.1 Carrier Tape Dimensions

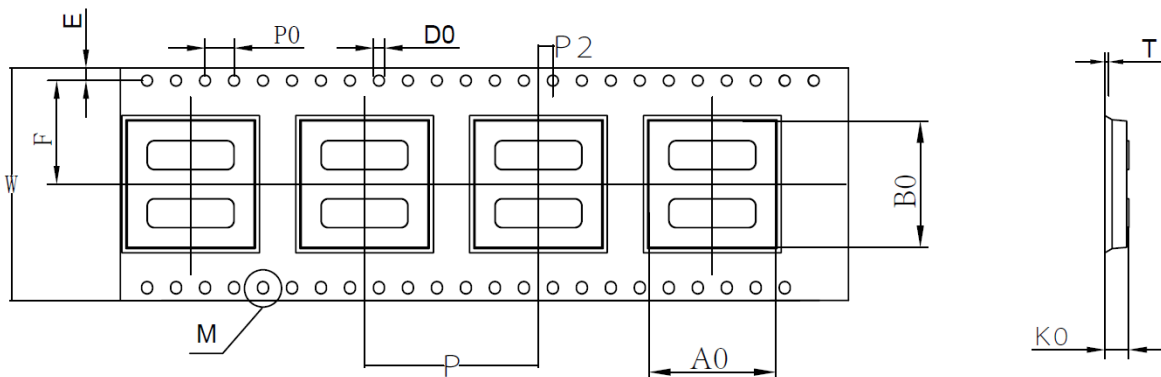

ITEM	W	A <sub>0</sub>	B <sub>0</sub>	K <sub>0</sub>	K <sub>1</sub>	P	F	E	D <sub>0</sub>	D <sub>1</sub>	P <sub>0</sub>	P <sub>2</sub>	T
DIM	32.0 <sup>+0.30</sup> <sub>-0.30</sub>	17.50 <sup>+0.10</sup> <sub>-0.10</sub>	17.40 <sup>+0.10</sup> <sub>-0.10</sub>	3.00 <sup>+0.10</sup> <sub>-0.10</sub>	0.00 <sup>+0.00</sup> <sub>-0.00</sub>	24.00 <sup>+0.10</sup> <sub>-0.10</sub>	14.2 <sup>+0.10</sup> <sub>-0.10</sub>	1.75 <sup>+0.10</sup> <sub>-0.10</sub>	1.50 <sup>+0.10</sup> <sub>-0.00</sub>	0.00 <sup>+0.10</sup> <sub>-0.00</sub>	4.00 <sup>+0.10</sup> <sub>-0.10</sub>	2.00 <sup>+0.10</sup> <sub>-0.10</sub>	0.30 <sup>+0.05</sup> <sub>-0.05</sub>

Figure 17 - Carrier Tape Dimensions

### 17.2 Reel Packaging

Modules are packaged on 330mm reels loaded with 1000 modules. Each reel is placed in an antistatic bag with a desiccant pack and humidity card and placed in a 340x350x65mm box. An antistatic warning and reel label are adhered to the outside of the bag.

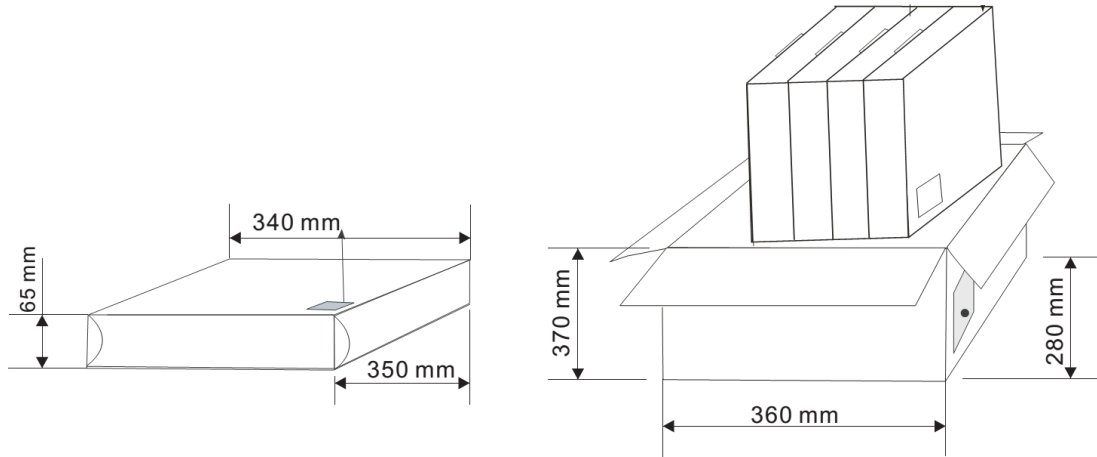

Figure 18 - Reel Cartons

### 17.3 Packaging Label

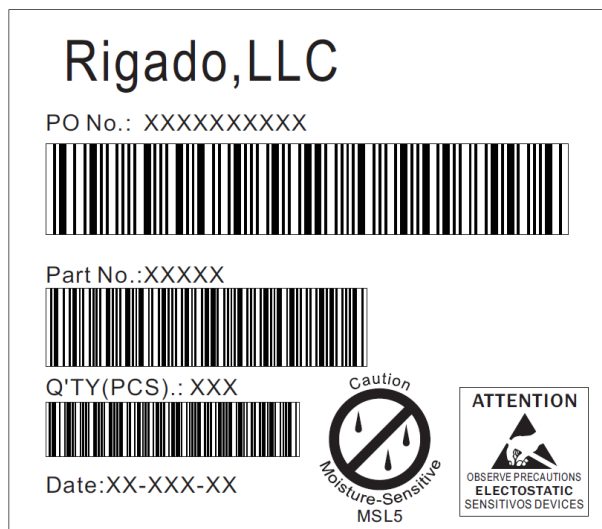

Figure 19 - Packaging Label

## 18 Cautions

- 1) The guidelines of this document should be followed in order to assure proper performance of the module.
- 2) This product is intended for use in office, business, and residential applications and not designed for medical applications. See the life support policy below for use in medical applications.
- 3) This module may short-circuit. If a short circuit can result in serious damage or injury, then failsafe precautions should be used. This could be accomplished by redundant systems and protection circuits.
- 4) Supply voltage to the module should not be higher than the specified inputs or reversed. Additionally, it should not contain noise, spikes, or AC ripple voltage.
- 5) Avoid use with other high frequency circuits.
- 6) Use methods to eliminate static electricity when working with the module as it can damage the components.
- 7) Contact with wires, the enclosure, or any other objects should be avoided.
- 8) Refer to the recommended land pattern when designing for this module.
- 9) If hand soldering is used, be sure to use the precautions outlined in this document.
- 10) This module should be kept away from heat, both during storage and after installation.
- 11) Do not drop or physically shock the module.
- 12) Do not damage the interface surfaces of the module.
- 13) The module should not be mechanically stressed at any time (storage, handling, installation).
- 14) Do not store or expose this module to:
  - Humid or salty air conditions
  - High concentrations of corrosive gasses.
  - Long durations of direct sunlight.
  - Temperatures lower than -40°C or higher than 125°C.

## 19 Life Support and other High-Risk Use Warning

This product is not designed nor intended for use in a life support device or system, nor for use in other fault-intolerant, hazardous or other environments requiring fail-safe performance, such as any application in which the failure or malfunction of the product could lead directly or indirectly to death, bodily injury, or physical or property damage (collectively, "High-Risk Environments"). RIGADO EXPRESSLY DISCLAIMS ANY EXPRESS OR IMPLIED WARRANTY OF FITNESS FOR USE IN HIGH-RISK ENVIRONMENTS. The customer using this product in a High-Risk Environment agrees to indemnify and defend Rigado from and against any claims and damages arising out of such use.

## 20 Related Documents

### Rigado Documents:

Visit the [Rigado File Downloads](#) page for BMD-200 documentation.

- BMD-200-EVAL-UG: Evaluation Kit User Guide
- RIGDFU-DS-1: RigDFU Secure Bootloader Datasheet
- BMDWARE-DS-1: BMDware Datasheet

### Nordic Semiconductor Documents:

Visit the [Nordic Document Library](#) for a comprehensive library of Nordic technical documentation.

- nRF51822-PS: nRF51822 Product Specification
- nRF51 RM: nRF51 Series Reference Manual
- S110-SDS: nRF51822 S110 SoftDevice Specification
- S120-SDS: nRF51822 S120 SoftDevice Specification
- S130-SDS: nRF51822 S130 SoftDevice Specification
- nRF51822-PSA-ITEMP: nRF51822 Product Specification Addendum for industrial temperature range

## 21 Contact Information

Headquarters

Rigado Inc.  
3950 Fairview Industrial Drive SE, Suite  
100  
Salem, Oregon 97302

Portland

Rigado Inc.  
101 SW Main Street, Suite 2000  
Portland, Oregon 97204

Tel: +1 971 208 9870

Fax: +1 971 208 9869

Sales: <https://www.rigado.com/contact/>

Support: <https://rigado.zendesk.com/hc>

## 22 List of Tables

Table 1 - Ordering Information .....	2
Table 2 - Quick Specifications.....	3
Table 3 - Pin Descriptions .....	4
Table 4 - Absolute Maximum Ratings .....	5
Table 5 - Operating Conditions .....	5
Table 6 - GPIO.....	6
Table 7 - 32.768kHz Crystal (LFXO).....	6
Table 8 - 32.768kHz Clock Source Comparison .....	7
Table 9 - Document History .....	3

## 23 List of Figures

Figure 1 - Block Diagram .....	2
Figure 2 - BMD-200 Pin-out.....	4
Figure 3 - MAC Address on Label .....	12
Figure 4 - Mechanical Drawing .....	13
Figure 5 - Recommended PCB Land Pads.....	13
Figure 6 - Module Marking - Rev A - BMD-200-A (16kB) .....	14
Figure 7 - Module Marking - Rev B - BMD-200-B (32kB) .....	14
Figure 8 - Recommended RF Layout & Ground Plane.....	15
Figure 9 - BMD-200 X-Y-Z Orientation .....	16
Figure 10 - S33 Antenna Smith Chart.....	16
Figure 11 - 3D Radiation Pattern .....	17
Figure 12 - XY-plane Radiation Pattern .....	18
Figure 13 - XZ-plane Radiation Pattern .....	18
Figure 14 - YZ-plane Radiation Pattern .....	18
Figure 15 - Japan MIC Mark.....	24
Figure 16 - Reflow Profile for Lead Free Solder.....	25
Figure 17 - Carrier Tape Dimensions .....	25
Figure 18 - Reel Cartons .....	26
Figure 19 - Packaging Label .....	26



## 24 Document History

Revision	Date	Changes / Notes
1.0	2014-10-20	Initial Release
1.1	2015-01-20	Added BMD-200-B, Corrected Section 7.2 'Operating supply voltage', other minor edits
1.2	2015-06-12	Added new factory firmware, reel size changed to 1000 units
1.3	2015-12-01	Added sections 6.1 and 6.2 for RigDFU and BMDware pin assignments, Added section 8.1.3 for Firmware version AC, other minor edits
1.4	2016-02-25	Added Japan TELEC Type Acceptance certification
1.5	2016-06-06	Added new factory firmware, renamed TELEC to MIC, Updated logo
1.6	2016-06-08	Added section for module programming and read-back protection, included other beacon types
1.7	2017-08-02	Updated for CE RED
2.0	2019-02-01	Updated to new format Updated Life Support and other High-Risk Use Warning Included NRND Note in Section 5, Ordering Information
2.1	2019-02-28	Updated links to Nordic Semiconductor web pages

*Table 9 - Document History*