

ILD6150/ILD6070 – 60 V buck LED driver IC with high accuracy and efficiency

Operation, design guide and performance

About this document

Scope and purpose

This application note introduces Infineon's hysteretic buck DC-DC LED driver ILD6150/ILD6070 for general lighting applications. It describes the operation of the device, its features and how to select values of the passive components. As an example an available reference design and its performance is presented, as well as design ideas for various applications. The ILD6150/ILD6070 offers high efficiency, various protection features, flexible dimming options and reliability for high-performance lighting systems.

Intended audience

This document is intended for users who wish to design high-efficiency, high-reliability lighting systems with Infineon's ILD6150 (up to 1.5 A)/ILD6070 (up to 700 mA) DC-DC LED driver.

Table of contents

Operation, design guide and performance	1
About this document.....	1
Table of contents.....	1
1 Introduction	3
1.1 Features	3
1.2 Application	3
2 Circuit description.....	4
2.1 Operation.....	4
2.1.1 Current regulation.....	4
2.1.2 Over Current Protection (OCP)	5
2.1.3 Over Temperature Protection (OTP)	5
2.1.4 Under Voltage Lockout (UVLO)	5
2.1.5 Dimming	5
2.1.6 Soft-start.....	5
2.2 Component selection.....	6
2.2.1 Sense resistor	6
2.2.2 Selection of inductor and operating frequency.....	6
2.2.3 Selection of diode D	6
2.2.4 Selection of input capacitor C_{IN}	7
2.2.5 Selection of output capacitor C_{OUT}	7
2.2.6 Selection of R_{Tadj}	7

Introduction

2.3	Layout consideration	8
2.4	Design example	8
2.4.1	Determine R_{SENSE}	8
2.4.2	Select switching frequency	8
2.4.3	Calculation of inductor value and currents	8
2.4.4	Diode selection	9
2.4.5	Selection of capacitor C_{IN}	9
2.4.6	Selection of capacitor C_{OUT}	9
3	Application circuit	10
3.1	Schematic layout	10
3.2	PCB layout	10
3.3	PCB photo	11
4	Measurement results with reference design	12
4.1	LED current vs supply voltage	12
4.2	PWM dimming	13
4.3	Analog dimming	13
4.4	Soft-start	14
4.5	OCP	15
4.6	Efficiency	15
4.7	Thermal behavior	16
4.8	Output current ripple	16
5	Application with flyback converter XDPL8218	17
6	Appendix A	18
	References	19

1 Introduction

This application note introduces Infineon's buck LED driver IC ILD6150/ILD6070. ILD6150 and ILD6070 are identical except for maximum current allowed, and hereafter ILD6150 means ILD6070 as well. ILD6150 offers high efficiency, multiple protection features, flexible dimming options and reliability for high-performance lighting systems.

ILD6150 is a hysteretic buck driver IC for use in general LED lighting applications with average currents up to 1.5 A. The hysteretic concept of current control is extremely fast and always stable without the need for any loop compensation. It is suitable for applications with a wide range of supply voltages from 4.5 V to 60 V, allowing input operation up to the maximum Safety Electrical Low Voltage (SELV) of 60 V.

A multifunctional dimming input allows dimming of the LEDs with a DC voltage or a PWM signal.

A maximum contrast ratio of 3000:1 can be achieved depending on the external components. The efficiency of the LED driver is remarkably high, reaching up to 98 percent efficiency over a wide range. The output current variation from device to device and under all load conditions and over-temperature is limited to a minimum. The ILD6150 reference design can also be used as a constant current output second-stage DC-DC converter with a constant input voltage from a front stage AC-DC converter (XDPL8218), making ILD6150 the perfect fit for LED drivers.

1.1 Features

- Wide-input voltage range from 4.5 V to 60 V
- Capable of providing up to 1.5 A output current
- Up to 1 MHz switching frequency
- Soft-start capability
- Analog and PWM dimming input signal possible
- Typical 3 percent output current accuracy
- Very low LED current drift over-temperature
- Under Voltage Lockout (UVLO)
- Over Current Protection (OCP)
- Thermally optimized package: PG-DSO-8-27
- Adjustable Over Temperature Protection (OTP)

1.2 Application

- LED drivers for general lighting
 - with single output channel
 - with two output channels for tunable white light
- LED drivers for horticultural lighting
 - with multiple output channels

2 Circuit description

2.1 Operation

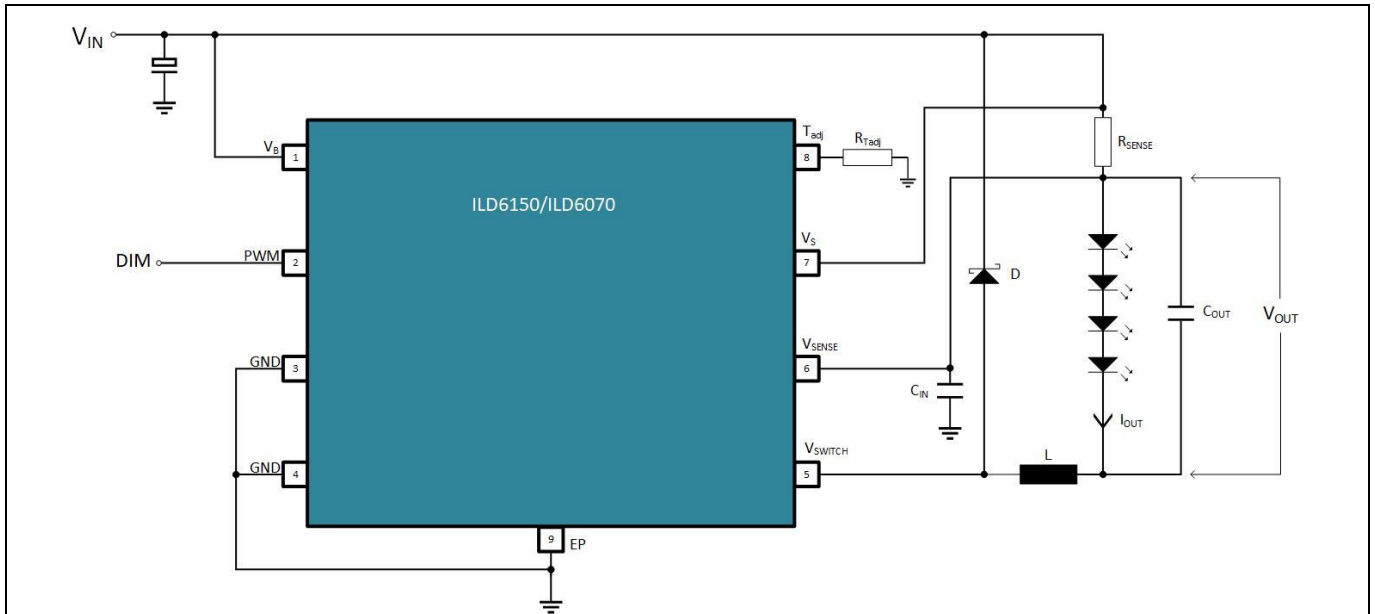

Figure 1 Application schematic

2.1.1 Current regulation

Under normal operating conditions the LED current I_{OUT} is controlled by means of the voltage difference between pins V_S and V_{SENSE} , which is proportional to the current through R_{SENSE} . This voltage is compared to two threshold levels, and the internal switch is turned on and off accordingly.

As long as the difference is above the lower internal threshold V_{THL} , the MOSFET is in the on-state and the current through R_{SENSE} and load is rising linearly with the slope:

$$\frac{dI_{OUT}}{dt} = \frac{V_{IN} - V_{OUT}}{L}$$

As soon as the threshold is crossed the MOSFET is turned off and current through R_{SENSE} is now decreasing with the slope:

$$\frac{dI_{OUT}}{dt} = -\frac{V_D + V_{OUT}}{L}$$

until the higher threshold voltage V_{THH} is hit. Now the MOSFET is turned on again and the above described cycle is repeated.

Obviously the converter operates in Continuous Conduction Mode (CCM) and the average output current I_{OUT} can be determined by means of the average threshold $V_{SENSE} = (V_{THH} + V_{THL})/2 = 152 \text{ mV}$ in the case of ILD6150.

The peak-to-peak ripple amplitude of I_{OUT} only depends on the hysteresis $V_{SENSEHYS}$, which in the case of ILD6150 is 44 percent of V_{SENSE} or 67 mV.

Circuit description

2.1.2 Over Current Protection (OCP)

ILD6150 has two OCP techniques. First, the output current is within limitation even if the output gets shorted as long as R_{SENSE} is not damaged. Second, ILD6150 has OCP, which is triggered when the MOSFET current is higher than 2.5 A typically. This can happen when R_{SENSE} is shorted or damaged. Although the IC will not be damaged in this case the OCP feature does not guarantee the protection of the LEDs.

2.1.3 Over Temperature Protection (OTP)

ILD6150 has an integrated OTP based on the junction temperature on chip. OTP is required to prevent the IC from operating at a potentially destructive temperature. The threshold of the OTP can be set by resistor R_{Tadj} connected from pin T_{adj} to GND. The OTP is based on modulation of the LED current with an internal PWM generator. Once the junction temperature exceeds the OTP threshold the PWM duty cycle as well as the average LED current will be reduced. Once junction temperature reaches threshold $T_{OTP,off}$ the PWM duty cycle and LED current will be reduced to zero.

2.1.4 Under Voltage Lockout (UVLO)

UVLO is implemented to protect the IC from operating at insufficient supply voltage. ILD6150 incorporates an UVLO that will shut down the IC when the minimum supply voltage falls below the internal threshold of typically 4.25 V.

2.1.5 Dimming

A multifunctional input allows dimming of the LED current either by means of a DC voltage or a PWM signal applied to this pin. To minimize color-shift of the LEDs, independent of the type of input, an internal 1.6 kHz PWM signal is generated that modulates the LED current.

Depending on which type of signal is applied, the duty cycle of this internal PWM signal is either proportional to the DC voltage or to the duty cycle of the signal at the dimming pin.

2.1.6 Soft-start

Soft-start helps to reduce component stress when the application starts and can also be used to effect a slow increase of light output, if desired. This can be achieved by adding a capacitor at the PWM pin. ILD6150 having an internal current source of 18 μ A will charge up the capacitor at the PWM pin from 0 V to 4.7 V linearly.

Refer to the specification of the analog dimming; the linear range of the output current from 0 percent to 100 percent is within the range from 0.67 V to 2.43 V. Hence the value of ΔV is equal to 1.76 V and the current i is equal to 18 μ A. The soft-start timing can be calculated using below equation:

$$C = \frac{\Delta t \cdot i}{\Delta V} = \frac{\Delta t \cdot 18 \mu A}{1.76 V} = \Delta t \cdot 10.2 \mu$$

If a capacitor of more than a few hundred pF is attached to the PWM pin, dimming with a PWM input may be difficult due to high displacement currents flowing.

Circuit description

2.2 Component selection

2.2.1 Sense resistor

The average LED current is determined by the value of the external current sense resistor (R_{SENSE}). As mentioned above, the mean current sense threshold voltage is $V_{SENSE} = 152\text{ mV}$. Therefore the proper value of R_{SENSE} is given by:

$$R_{sense} = \frac{152\text{mV}}{I_{OUT}}$$

2.2.2 Selection of inductor and operating frequency

The inductor shall supply a constant current to the LED. In CCM the inductor value L is related to the switching frequency f_{SW} , as shown below:

$$L = \frac{1}{\Delta i \cdot f_{SW} \cdot \left(\frac{1}{V_{IN} - V_{OUT}} + \frac{1}{V_{OUT}} \right)}$$

where V_{IN} is the input voltage, V_{OUT} is the output voltage and Δi is current ripple, which is given by:

$$\Delta i = V_{SENSEHYS} \cdot I_{OUT} = 0.44 \cdot I_{OUT}$$

where $V_{SENSEHYS}$ is sense threshold hysteresis.

For a given inductor value f_{SW} will vary with varying input and output voltage. Selection of operating frequency is a trade-off between system efficiency and switching noise on the one hand, and inductor and board size and cost on the other. As the frequency increases so do switching noise and losses, while the size and cost of the inductor and capacitor decrease. The switching losses become the major driving factor as V_{IN} increases to higher voltages.

To maintain best regulation capability of the LED driver IC it is reasonable to keep a margin to the minimum switch-on and switch-off times defined by internal propagation delay times. Disregard of this recommendation by choosing inductor values that are too small might result in an increased LED current ripple and loss of LED current regulation accuracy. Minimum 350 ns on- and off-times are recommended as a reasonable design target for the inductor selection.

The saturation current I_{sat} of the chosen inductor has to be higher than the peak LED current $I_{pk} = I_{OUT} + \Delta i/2$, and its continuous current needs to exceed the average LED current I_{OUT} .

2.2.3 Selection of diode D

Once the switch turns off, the residual energy of the inductor is discharged through the diode into the output capacitor and the LED load. Typically a Schottky diode is used to reduce losses caused by the diode forward voltage and reverse recovery times.

The first parameter to consider when selecting a diode is its maximum reverse voltage V_{BR} . This voltage rating must be higher than the maximum input voltage V_s of the circuit: V_{BR} greater than V_s .

The other two parameters defining the diode are average and RMS forward currents $I_{D,AVG}$ and $I_{D,RMS}$, which are given by:

$$I_{D,AVG} = I_{OUT} \cdot (1 - d)$$

$$I_{D,RMS} = I_{OUT} \cdot \sqrt{1 - d} \cdot \sqrt{1 + \frac{1}{12} \cdot \left(\frac{\Delta i}{I_{OUT}} \right)^2}$$

where d is the duty cycle of the switching waveform and is given by:

$$d = \frac{V_{OUT}}{V_{IN}}$$

The diode must be chosen so that its respective current ratings are higher than these values. Reverse blocking capability should be higher than V_{IN} , with a meaningful margin of 25 percent or so.

Circuit description

2.2.4 Selection of input capacitor C_{IN}

The input current of the buck controller is identical to the current through the MOSFET – i.e. it is pulsating and thus causes a ripple voltage at the input. A capacitor close to pin V_S reduces this ripple voltage by providing current when the switch is conducting. The RMS current through the input capacitor $I_{C,RMS}$ is purely AC and can be calculated from average and RMS inputs currents $I_{IN,AVG}$ and $I_{IN,RMS}$ as:

$$I_{C,RMS}^2 = I_{IN,RMS}^2 - I_{IN,AVG}^2$$

Hence,

$$I_{C,RMS} = I_{OUT} \cdot \sqrt{d \cdot \left(1 - d + \frac{1}{12} \cdot \left(\frac{\Delta i}{I_{OUT}}\right)^2\right)}$$

Use low-ESR capacitors, especially under high switching frequency applications. With low-ESR capacitors, the input voltage ripple can be estimated by:

$$\Delta V_S = \frac{I_{OUT}}{f_{SW} \cdot C_{in}} \cdot d \cdot (1 - d)$$

$$C_{IN} \geq \frac{I_{OUT}}{f_{SW} \cdot \Delta V_S} \cdot d \cdot (1 - d)$$

The input capacitor must be chosen so that it is capable of withstanding the calculated RMS current rating and reducing input voltage ripples to an acceptable level.

2.2.5 Selection of output capacitor C_{OUT}

Due to the relatively low ripple current of a buck with ILD6150 a capacitor in parallel to the LED that reduces ripple even further is not needed in many applications.

Due to the non-linear I-V characteristic of LED it is very difficult to estimate the ripple voltage with and without output capacitor. A generally accepted model is the approximation of LED V-I characteristic by a voltage source V_{FD} , which models the forward voltage of the LED with a series resistor R_D to model differential resistance. Both parameters need to be determined from the LED datasheet. As a rule of thumb a V_{FD} of 2.8 V and a differential resistance R_D of 0.4 Ω are very reasonable values for typical white, high-power LED. Consequently, for 12 LEDs in series this would lead to a V_{FD} of 33.6 V and a total R_D of 4.8 Ω . The ripple voltage without capacitor is then approximated as:

$$\Delta V_{OUT} \cong \Delta i \cdot R_D$$

A meaningful output capacitor should therefore have an impedance at f_{SW} which is at least five to ten times lower than R_D :

$$C_{OUT} \gg \frac{5}{2\pi \cdot f_{SW} \cdot R_D}$$

2.2.6 Selection of R_{Tadj}

ILD6150 has an integrated OTP based on the junction temperature on chip. The threshold of the OTP circuit is tunable by resistor R_{Tadj} connected from pin T_{adj} to GND. R_{Tadj} resistor values within 0 to 35 k Ω define the OTP behavior. R_{Tadj} values greater than or equal to 150 k Ω set the OTP threshold to $T_{OTP,open}$. OTP is based on modulation of the LED current with an internal PWM generator. Once the junction temperature exceeds the OTP threshold the PWM duty cycle as well as the average LED current will get reduced. Once the junction temperature reaches $T_{OTP,off}$ the PWM duty cycle and LED current will be reduced to zero. Adjustable OTP offers great flexibility with the starting point of the current reduction at high temperature, and can be designed according to the LED lamp requirement.

Circuit description

2.3 Layout consideration

An optimized PCB layout leads to better performance, reliability and lower cost. Certain layout guidelines must be kept in mind while routing the PCB.

The power components include the internal switch, Schottky diode, input capacitor, output capacitor and inductor. Route the input capacitor close to the IC, as parasitic inductance can be minimized by minimizing trace lengths and using short and wide traces. Extra parasitic inductance between the input capacitor's terminals and the IC's V_B and GND terminals creates high dv/dt due to the switching process. This can lead to IC failure. Also, place the inductor as close as possible to the IC to reduce radiated EMI.

The output capacitor completes the routing of all the power components. It is the final component connected to the power ground terminal in the system. An improper output capacitor placement typically causes poor output voltage regulation. To ensure optimum operation, take care to minimize the area of the power-current loop.

The small-signal control components consists of all analog and digital components indirectly related to the power conversion like the sense voltage pin, soft-start capacitor, etc., and are sensitive to noise. To reduce the noise coupling from the power stage to the control circuitry, it is necessary to keep the noisy switching traces far from the sensitive small-signal traces. To minimize noise and ensure good output voltage regulation, it is critical to keep the V_{SENSE} path as small as possible, and it is desirable to return the ground of the small signal component to a "clean" point. Poor routing of small-signal components may lead to poor output voltage regulation.

Keep separate grounds for power components, which are noisy, and for the small-signal components, which are quiet. Then join these two grounds at one point, possibly the exposed pad under the IC, which is also the IC ground. A grid of thermal vias can be created to improve the thermal conduction under the exposed pad. The above guidelines ensure a well laid-out power supply design.

2.4 Design example

As an example an LED driver with the following specification shall be designed:

$$V_S = 48 \text{ V}$$

$$I_{OUT} = 1 \text{ A}$$

$$V_{LED} = 36.3 \text{ V (12 pieces LED)}$$

2.4.1 Determine R_{SENSE}

$$R_{SENSE} = \frac{0.152 \text{ V}}{1 \text{ A}} = 0.152 \Omega$$

Next closest standard value of 0.15Ω will be used, increasing the nominal output current to $I_{OUT} = 1.013 \text{ A}$

2.4.2 Select switching frequency

90 kHz may be a reasonable compromise between switching loss and inductor size. This needs to be verified by measurement on the finished design.

2.4.3 Calculation of inductor value and currents

$$L = \frac{1}{1.013 \text{ A} \cdot 0.44 \cdot 90 \text{ kHz} \cdot \left(\frac{1}{48 \text{ V} - 36.3 \text{ V}} + \frac{1}{36.3 \text{ V}} \right)} = 220.5 \mu\text{H}$$

Circuit description

The next closest standard value is **220 μH** leading to a slightly higher f_{sw} .

The inductor average current is 1.013 A, while the peak current will be $I_{\text{pk}} = I_{\text{OUT}} + \Delta I/2 = I_{\text{OUT}} \cdot 1.22 = \mathbf{1.24 \text{ A}}$. Saturation current I_{SAT} of the inductor must be higher than the latter value.

2.4.4 Diode selection

To calculate diode currents the duty-cycle **d** is needed:

$$d = \frac{V_{\text{OUT}}}{V_{\text{IN}}} = \frac{36.3}{48} = \mathbf{0.756}$$

$$1 - d = \mathbf{0.243}$$

$$\text{RMS diode current: } I_{D,\text{RMS}} = 1.013 \cdot \sqrt{0.243 \cdot \left(1 + \frac{1}{12} \cdot \left(\frac{0.44}{1.013}\right)^2\right)} = \mathbf{0.503 \text{ A}}$$

$$\text{Average diode current: } I_{D,\text{AVG}} = 1.013 \cdot 0.243 = \mathbf{0.246 \text{ A}}$$

For a design with variable number of LEDs the highest diode currents will occur at the lowest output voltage. “1-d” is close to one under such conditions, and diode currents are close to output current. In general a 1 A diode is recommended as long as output current is below 1 A and a 2 A diode otherwise.

The reverse blocking voltage V_{BR} of the diode must be higher than the maximum input voltage V_{IN} . A 60 V diode is sufficient in this example, but a V_{BR} of 80 V will increase robustness and reliability of the design.

2.4.5 Selection of capacitor C_{IN}

$$C_{\text{IN}} \geq \frac{1.013}{90.2 \cdot 10^3 \cdot 0.01 \cdot 48} \cdot 0.756 \cdot 0.243 = \mathbf{4.30 \mu\text{F}}$$

The C_{IN} value depends on parameters “d,” I_{out} and f_{sw} , which are variables and can result in higher values of input capacitor. Therefore, a 47 μF electrolytic capacitor with a rated voltage of 100 V would be recommended in this case.

2.4.6 Selection of capacitor C_{OUT}

The value of C_{OUT} can be estimated as:

$$C_{\text{OUT}} \gg \frac{5}{2\pi \cdot 90.2 \text{ kHz} \cdot 4.8 \Omega} = \mathbf{1.84 \mu\text{F}}$$

For lower output voltage ripple a bigger output capacitor can be used. Since the value of this capacitor is relatively low even for low ripple demands an MLCC capacitor will be the best choice in terms of cost, lifetime and ESR. A 4.7 μF MLCC capacitor would be recommended in this case. If an electrolytic capacitor is used for any reason, attention needs to be paid to the ripple current capability and ESR. Rated voltage needs to be higher than the highest possible output voltage in any case.

Application circuit

3 Application circuit

This section provides more information about the reference design available for evaluation. The reference design is configured to have an output current of 1 A. The operating voltage range for the reference design can be from 4.5 V up to 60 V. The schematic, PCB layout and PCB photo are shown in Figure 2, Figure 3 and Figure 4 respectively. The bill of materials can be found in Appendix A.

3.1 Schematic layout

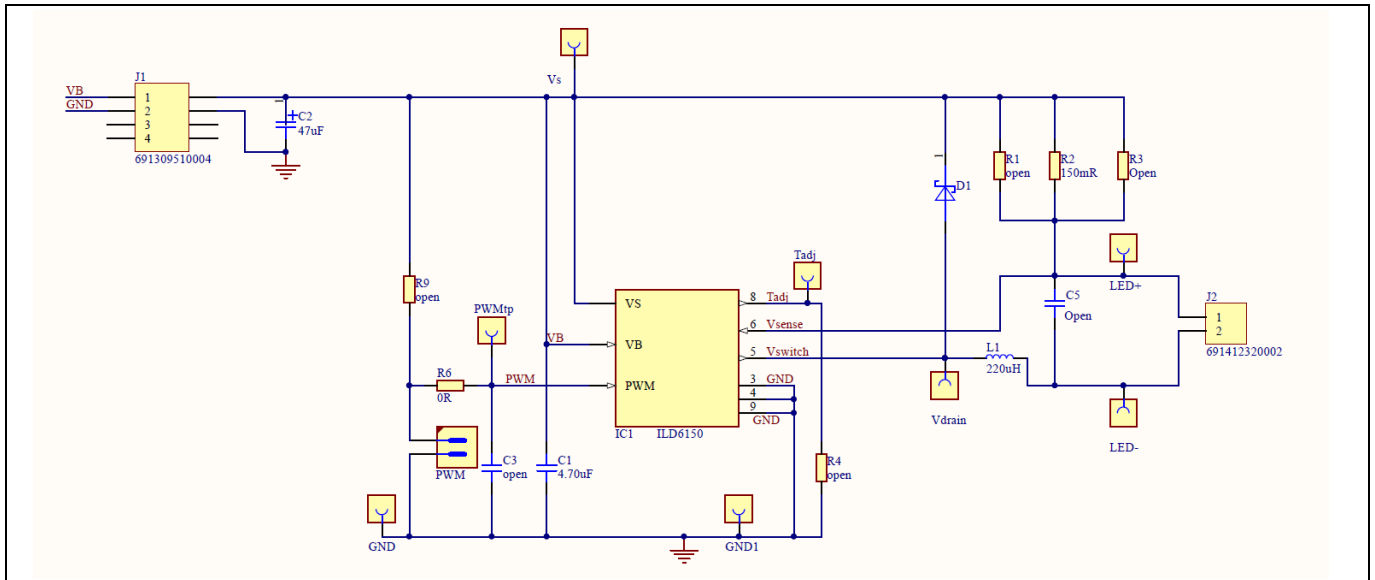

Figure 2 Schematic of the reference design

3.2 PCB layout

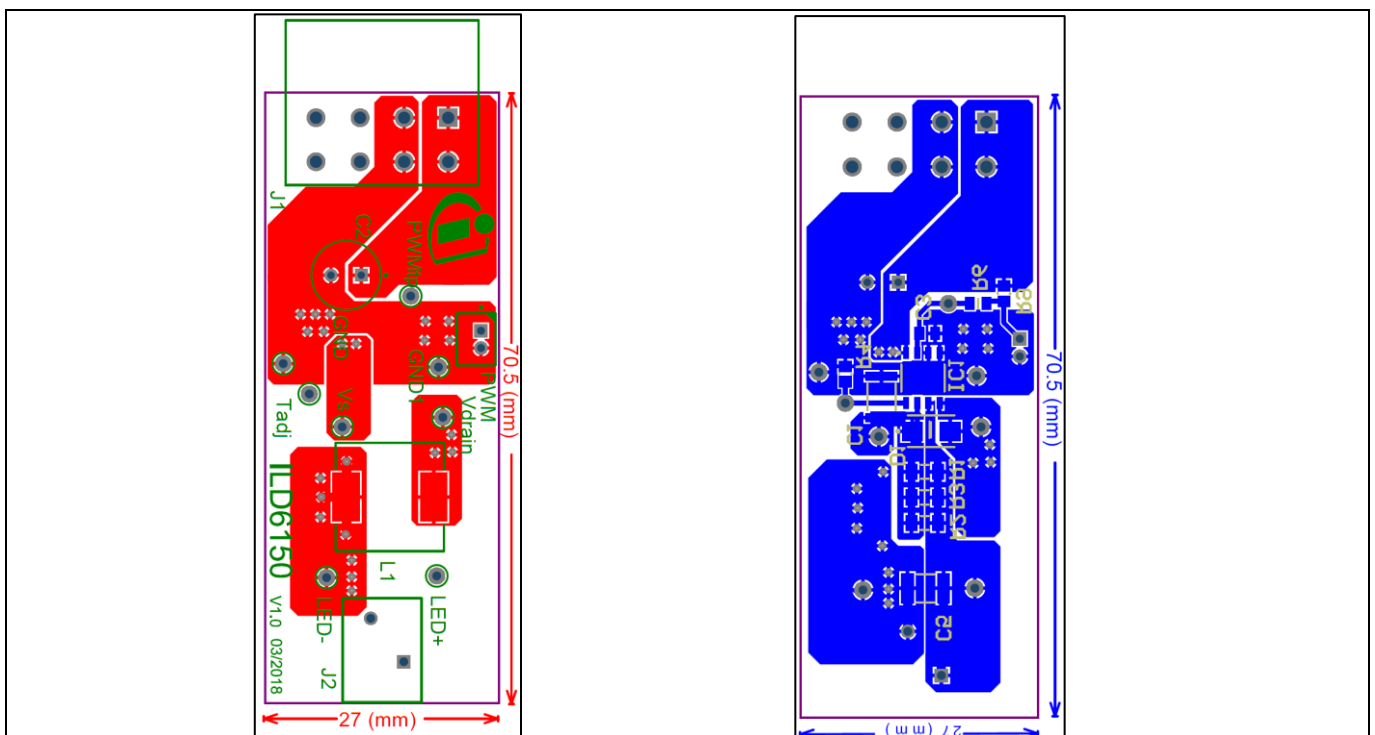

Figure 3 PCB layout of the reference design

3.3 PCB photo

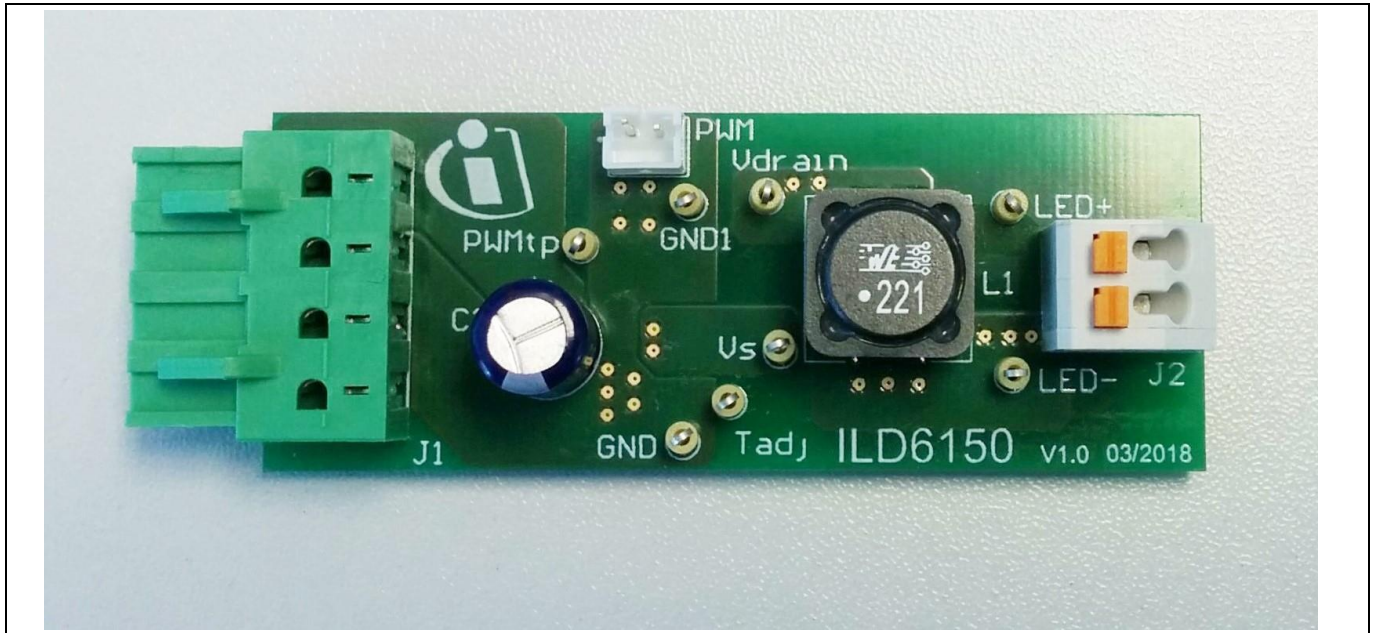

Figure 4 Photo of the reference design

4 Measurement results with reference design

Table 1 Typical condition for measurement

Vs	R _{SENSE}	Inductance	LED load
48 V	0.15 Ω	220 μH	12 pieces

Figure 5 shows the actual operating waveforms. The actual measured LED current is 1 A. The switching frequency is 92.4 kHz and the internal DMOS transistor on duty cycle is 78.9 percent.

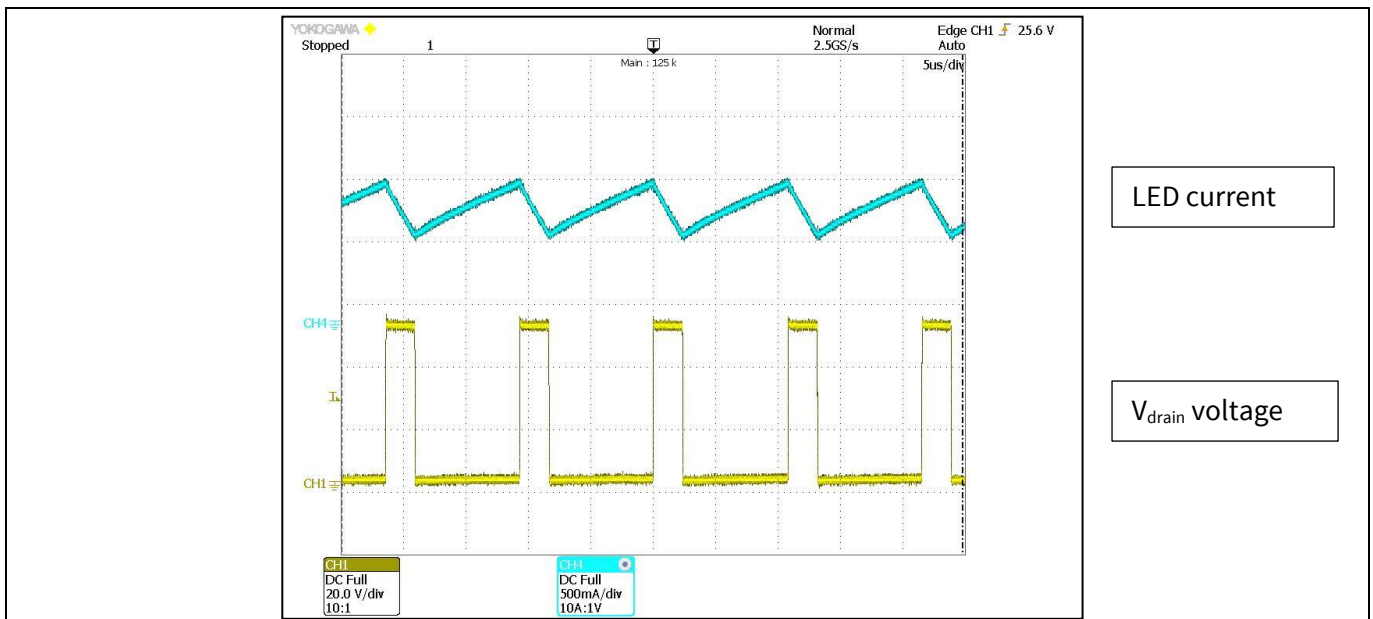

Figure 5 Normal operation waveform

4.1 LED current vs supply voltage

ILD6150 offers a high accuracy of output current despite the changes in supply voltage. Figure 6 shows the output current versus the supply voltage over the range of 40 V to 60 V. Over the supply range, the output LED current only deviates by 2 percent.

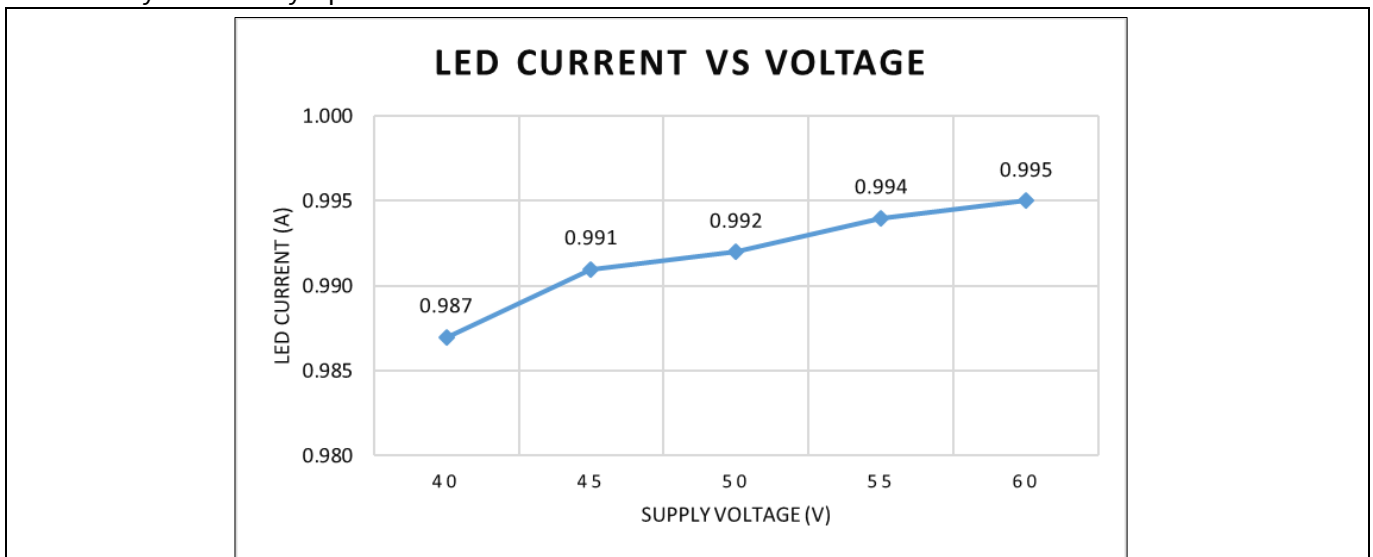

Figure 6 Output LED current vs supply voltage

Measurement results with reference design

4.2 PWM dimming

The multifunctional PWM input pin allows dimming of the LEDs with a PWM input. The LED current varies linearly with the duty cycle of the PWM pulse, as shown in Figure 7.

Table 2 Condition for PWM dimming

V_{PWM}	PWM frequency	LED
48 V	1 kHz	12 pieces

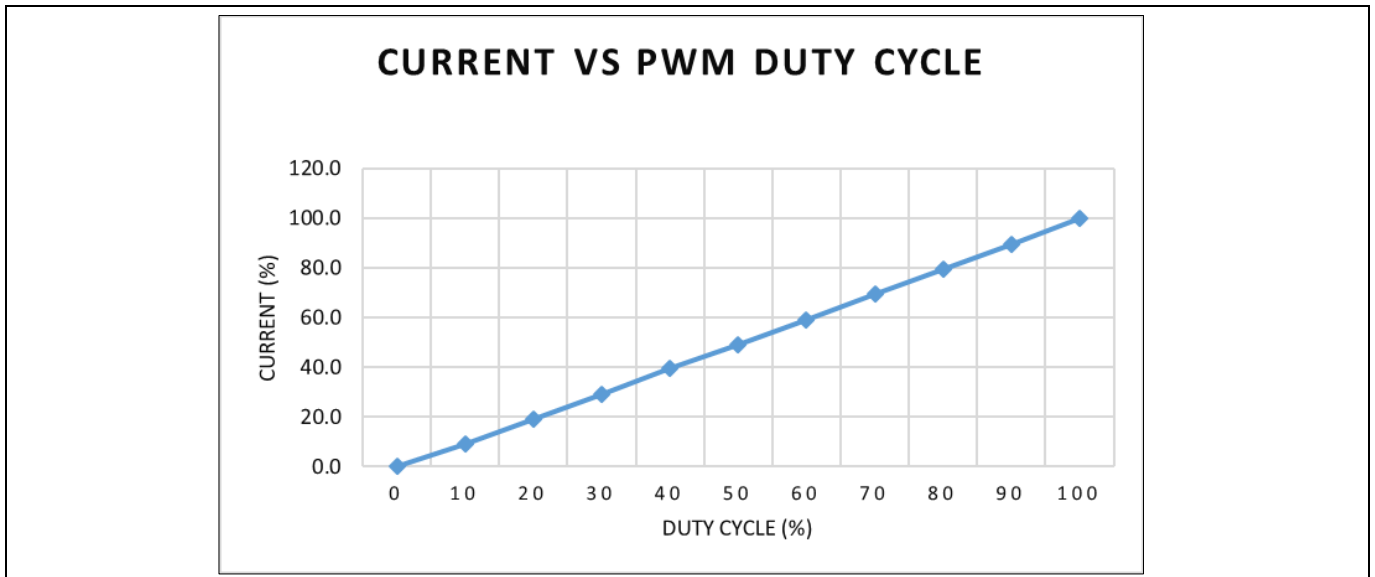

Figure 7 Output current vs duty cycle

4.3 Analog dimming

The multifunctional PWM input pin allows dimming of the LEDs with an analog DC voltage. The linear range of the analog dimming is from 0.5 V to 2.5 V. LEDs are fully turned on for voltage above 2.5 V and fully turned off for voltage below 0.5 V, as shown in Figure 8.

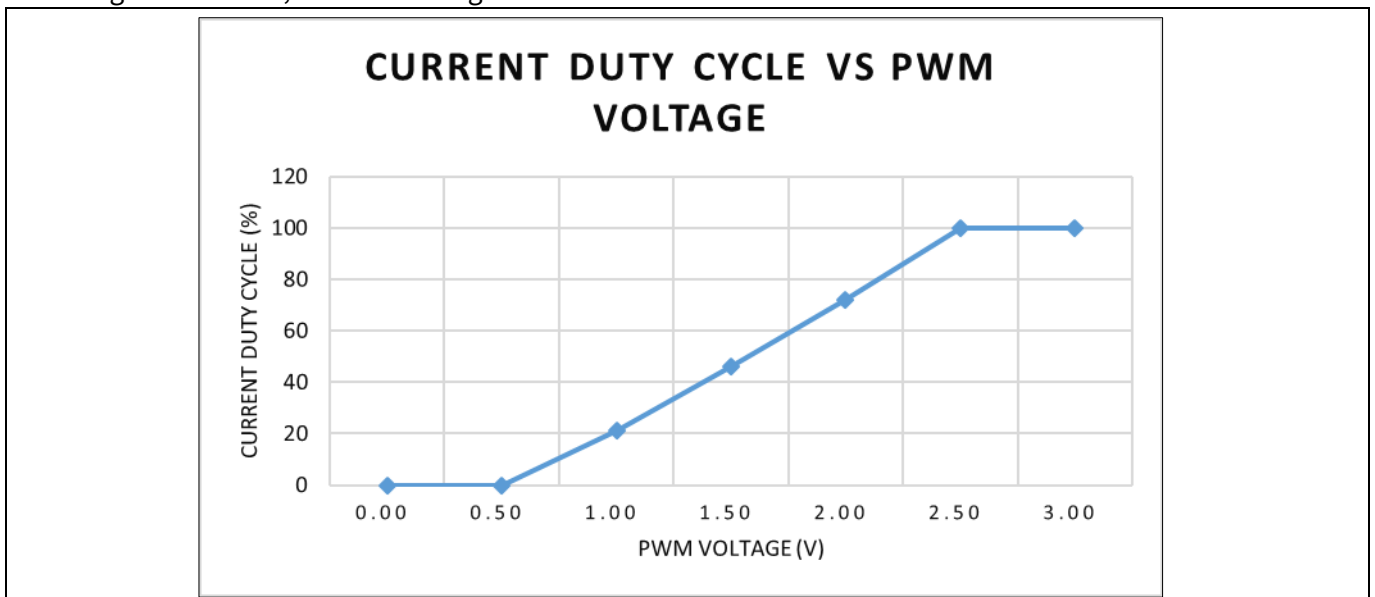

Figure 8 Analog dimming ratio vs PWM pin voltage

Measurement results with reference design

Figure 9 shows the output waveforms while the PWM pin voltage is equal to 1.5 V. The output current is modulated by the internal PWM signal at 1.6 kHz.

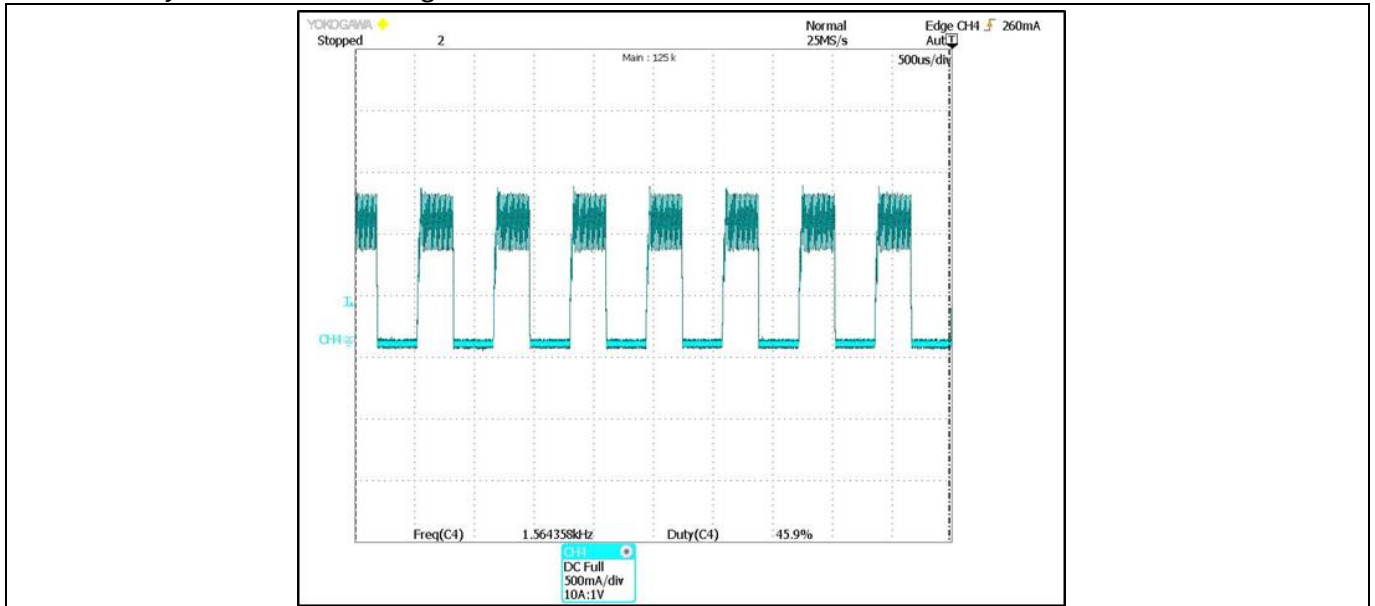

Figure 9 Output waveforms at $V_{PWM} = 1.5\text{ V}$

4.4 Soft-start

A capacitor with the value of $10\ \mu\text{F}$ is connected to the PWM pin, and the soft-start timing for the light output from 0 percent to 100 percent requires 0.978 s. Figure 10 shows the LED current waveform which is modulated by the PWM signal from 0 percent to 100 percent output. The actual measurement result for the soft-start is 0.700 s.

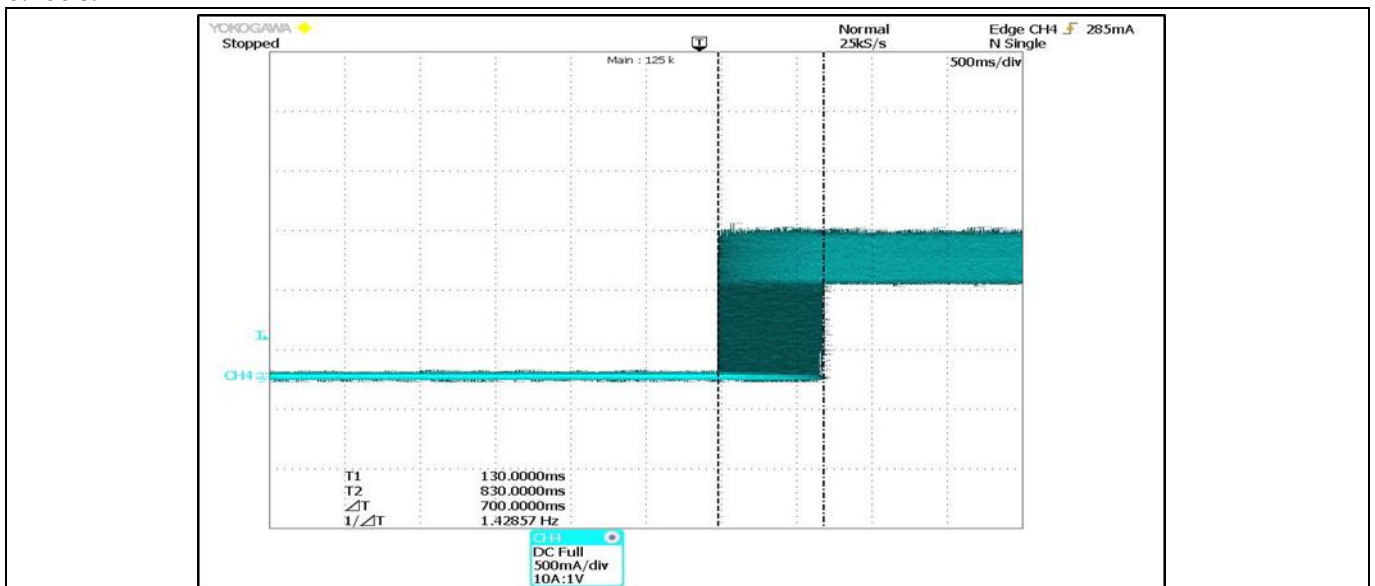

Figure 10 Soft-start with $10\ \mu\text{F}$ at the PWM pin

Measurement results with reference design

4.5 OCP

Figure 11 shows the waveforms where the ILD6150 is in OCP mode. The R_{SENSE} is shorted, and the LED's load is replaced by a DC electronic load with constant voltage of 0.01 V and supply voltage of 20 V.

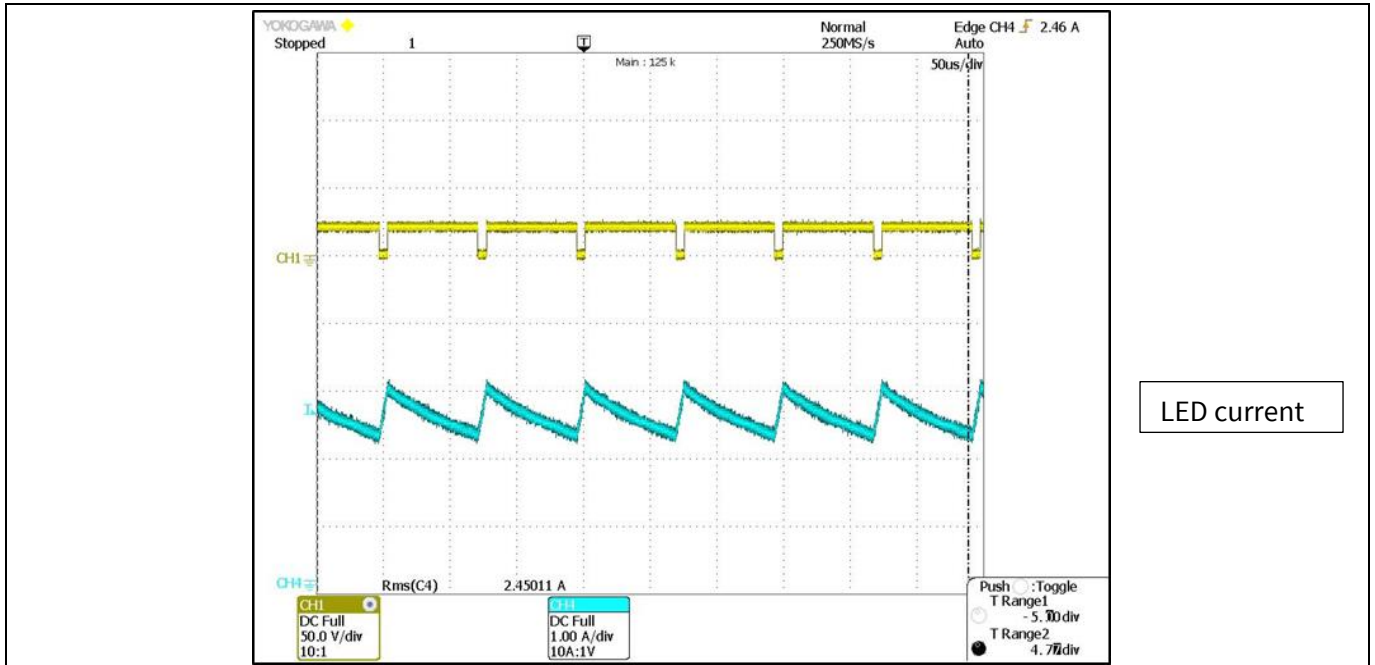

Figure 11 OCP waveforms

4.6 Efficiency

The measurement results of efficiency of the system for supply voltage (V_s) ranging from 40 V to 60 V can be found in Figure 12. The efficiency ranges from 94 percent to 98 percent for 12 pieces LED as load.

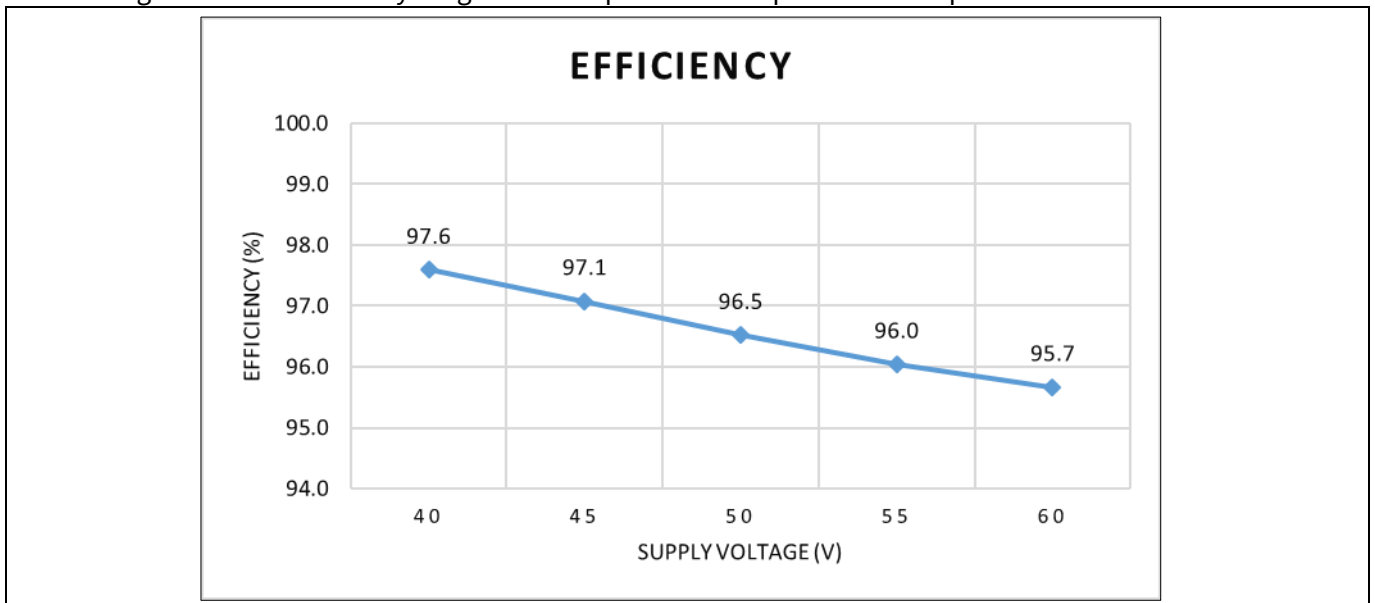

Figure 12 Efficiency vs supply voltage

Measurement results with reference design

4.7 Thermal behavior

The maximum temperature attained by the reference design is 96.6°C, as shown in Figure 13. The test is conducted with an input voltage of 60 V and with 10 pieces of LEDs as load. This condition results in maximum switching frequency, and therefore results in maximum temperature.

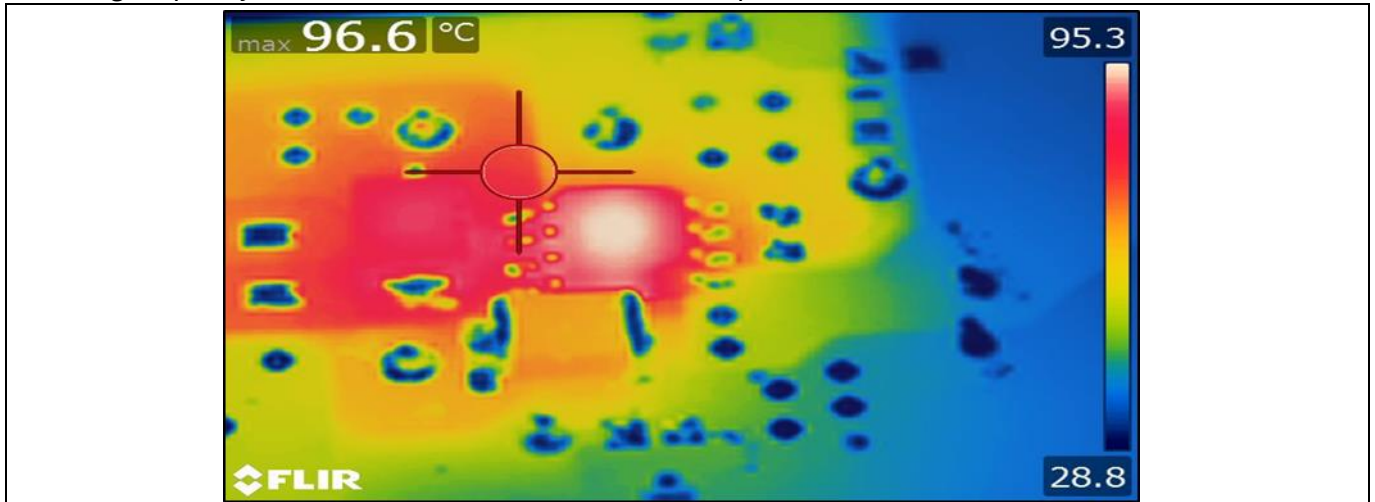

Figure 13 Maximum temperature on the reference design

4.8 Output current ripple

Figure 14 shows the waveform of the output current ripple with and without an output capacitor. It is observed that by placing a capacitor with value 2.2 μF the output voltage ripple reduces to 2.74 percent from the earlier value of 6.85 percent.

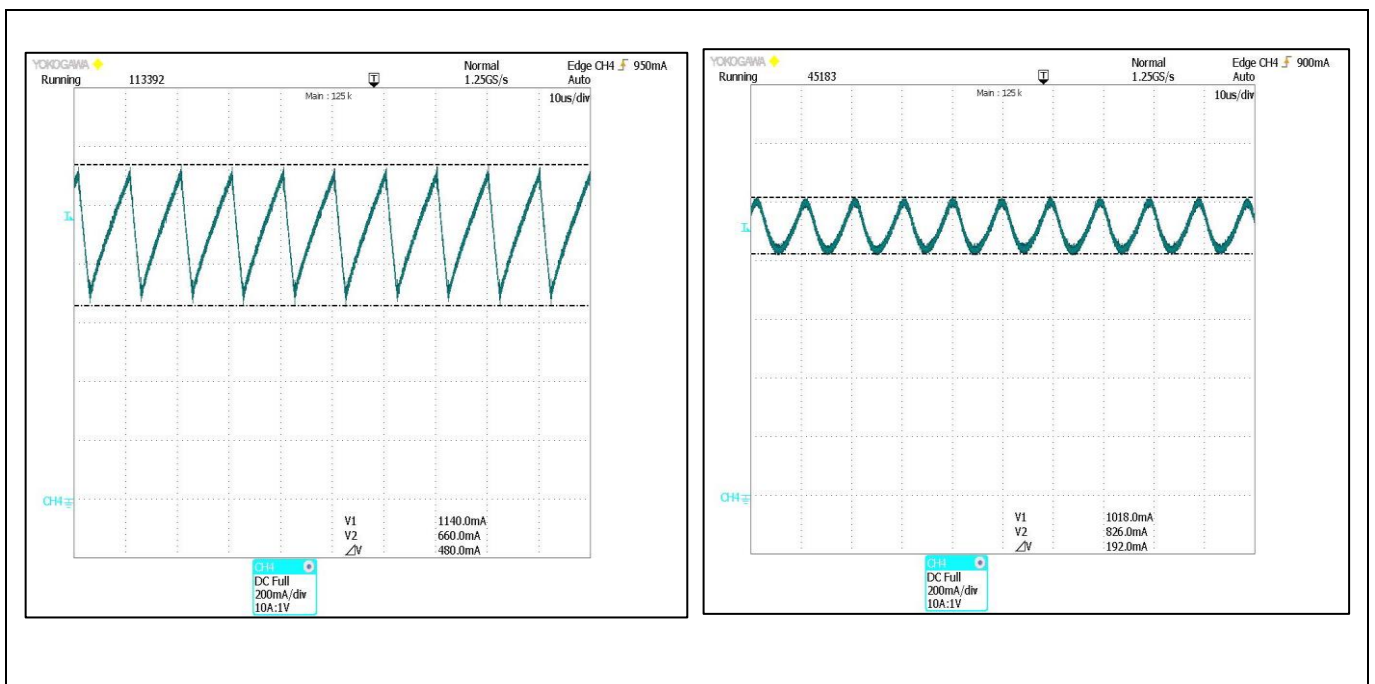

Figure 14 Output current ripple without C_{OUT} (left) and with C_{OUT} = 2.2 μF (right)

5 Application with flyback converter XDPL8218



Figure 15 Modular reference design consisting of AC-DC converter based on XDPL8218 with ILD6150 DC-DC buck

The XDPL8218 40 W reference design is a digitally configurable front-stage High Power Factor (HPF) flyback converter with universal AC input of 90 V_{rms} to 305 V_{rms} and Secondary Side Regulated (SSR) Constant Voltage (CV) output of 54 V. The CV output cannot be directly used to drive the LEDs. For LED lighting applications, it should be converted to Constant Current (CC) output by a second-stage DC-DC switching or linear regulator. The ILD6150 reference design can be used as the second-stage DC-DC buck converter, as shown in Figure 15. The ILD6150 hysteretic buck converter then operates with a fixed input voltage of 54 V. The efficiency of such a system is shown in Figure 16.

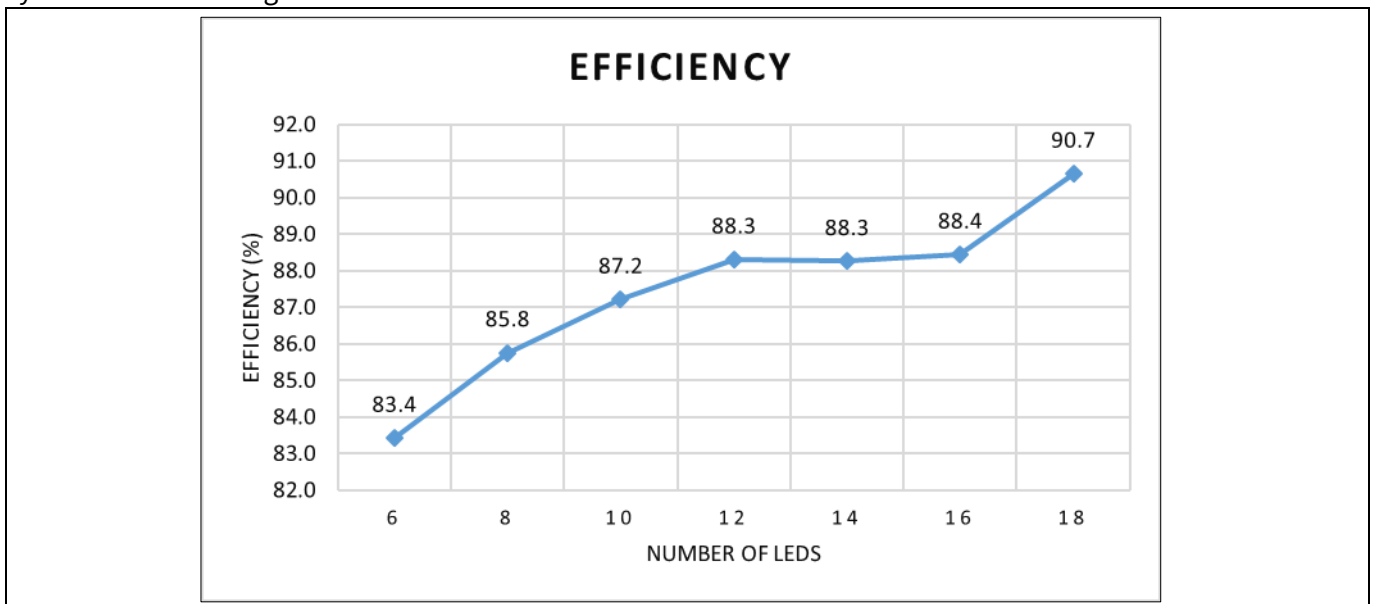

Figure 16 Efficiency of combined stages vs number of LEDs

6 Appendix A

Table 3 Bill of Materials (BOM)

Qty.	Designator	Value	Parameters	Manufacturer	Manufacturer order number
1	C1	4.70 μ F	V DC:100 V	TDK	CGA8N3X7S2A475K230KB
1	C2	47 μ F	V DC:100 V	Panasonic	ECA2AM470
1	D1		Ur:[100 V] If:[2 A]	Diodes Incorporated	B2100-13-F
8	GND, GND1, LED+, LED-, PWMtp, Tadj, Vdrain, Vs	VER_TESTPOINT_PTH		Vero Technologies	20-2137
1	IC1	ILD6150	V DC 4.5 V to 60 V; I _{OUT} 1.5 A:	Infineon	ILD6150XUMA1
1	J1	Reversed gender horizontal PCB header, 04 p	WR-TBL series 3095 – 5.08 mm reversed gender horizontal PCB header, 04 p	Würth Electronics	691309510004
1	J2	Screwless 45-degree entry, 2 p	WR-TBL series 4123 – 3.81 mm screwless 45-degree entry, 2 p	Würth Electronics	691412320002
1	L1	220 μ H	I DC:1.8 A	Würth Electronics	7447709221
1	PWM	2 p	Conn header PH TOP 2POS 2 mm	JST Corporation	B2B-PH-K-S(LF)(SN)
1	R2	150 mR	P:250 mW	Bourns Inc.	CRL1206-FW-R150ELF
1	R6	0 R	P:125 mW	Multicomp	MCMR08X000 PTL

References

Please refer to the ILD6150/ILD6070 datasheets for more information:

[ILD6150 datasheet](#)

[ILD6070 datasheet](#)

Trademarks

All referenced product or service names and trademarks are the property of their respective owners.

Edition 2018-09-17

Published by

Infineon Technologies AG

81726 Munich, Germany

© 2018 Infineon Technologies AG.

All Rights Reserved.

Do you have a question about this document?

Email: erratum@infineon.com

Document reference

AN_1809_PL39_1810_153959

IMPORTANT NOTICE

The information contained in this application note is given as a hint for the implementation of the product only and shall in no event be regarded as a description or warranty of a certain functionality, condition or quality of the product. Before implementation of the product, the recipient of this application note must verify any function and other technical information given herein in the real application. Infineon Technologies hereby disclaims any and all warranties and liabilities of any kind (including without limitation warranties of non-infringement of intellectual property rights of any third party) with respect to any and all information given in this application note.

The data contained in this document is exclusively intended for technically trained staff. It is the responsibility of customer's technical departments to evaluate the suitability of the product for the intended application and the completeness of the product information given in this document with respect to such application.

For further information on the product, technology, delivery terms and conditions and prices please contact your nearest Infineon Technologies office (www.infineon.com).

WARNINGS

Due to technical requirements products may contain dangerous substances. For information on the types in question please contact your nearest Infineon Technologies office.

Except as otherwise explicitly approved by Infineon Technologies in a written document signed by authorized representatives of Infineon Technologies, Infineon Technologies' products may not be used in any applications where a failure of the product or any consequences of the use thereof can reasonably be expected to result in personal injury.