



Wire Management Guide

Prepared For:

First Solar Series 6

Wire Management Guide

For First Solar Series 6

Scope of This Guide

While managing wire and cable for the new First Solar Series 6 is relatively straightforward, this wire management guide will help designers and installers avoid some common pitfalls of utility-scale wire management and this new module.

Many of the recommendations in this guide are general best practices for all solar installations, while others are specific to First Solar and single-axis trackers.

On a tracker system with mono-crystalline modules, module level wiring, or string wiring, is typically managed by attachment to the module itself. With the new Series 6 module, shorter leads and split junction boxes limit the need for those wires to be managed, but Series 6 – with its additional wire harnesses – presents a challenge that does not exist with mono-crystalline modules.

This guide presents several guidelines and techniques. Also covered are tips and techniques to manage cables between in-line trackers and from trackers to fixed structures, such as posts. Not discussed is row-to-row cable management, as that is dependent on many factors (geology, climate, access considerations, owner preference, etc.) and not within the scope of this guide.

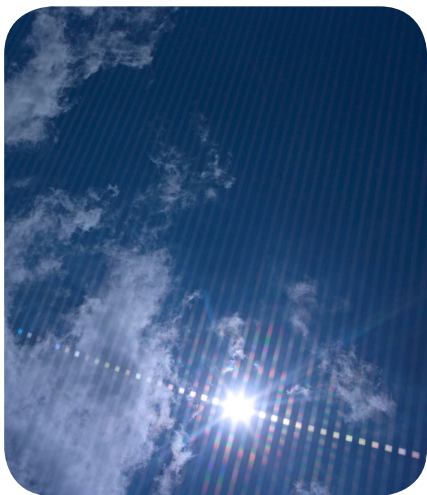

Technical Considerations of Single-Axis Trackers

PV cable is generally managed along the axis of the tracker close to the horizontal location of the junction box. This management requires affixing to the module structure itself as PV whips are typically not long enough to allow attachment to the tracker structure. It can present complications as modules lack standard dimensions for both mounting holes and frame profiles.

The Series 6 module changes this discussion, because it is completely uniform in its design. With an always consistent wire management hole size and location, routing location never needs to change.

Single-axis trackers follow the sun throughout the day. Trackers can have as much as a 60-degree range of motion and full rotations over 4,000 times a year.

This slow but steady movement must be considered, since inappropriate wire management will come loose or be severed if adjacent to sharp metal edges, or be pulled apart if inadequate slack is given.

This movement presents two complicating factors for wire management. First, wire management design must consider this movement as it shifts gravitational pull on an attachment mechanism throughout the day (we refer to an attachment mechanism as the part of a wire management device that attaches to the module – metal teeth, fir tree, etc.). Wire capture mechanisms (the part of a wire management device that retains the wire – slot in metal clip for cable, cable tie or plastic clasp, etc.) on these systems must also account for this shifting gravitational pull.

Second, as strings of cable are managed from the tracker (which moves) to fixed structures on the ground (that do not move) and from tracker to tracker (which both move but consideration must be made for the possibility that they may not move in unison), tension on cables must be considered.

Solar site conditions vary considerably, but several factors can be counted on as constants. First, solar sites have a high degree of UV exposure. Much of the wire management on a tracker will be sheltered from direct UV exposure but will still suffer from indirect exposure. Some wire management will face direct exposure all day long and materials must be chosen accordingly. Second, wires will be subject to movement due to wind, thermal expansion and contraction (which can move wires up to 3 inches in a single day) and tracker movement. All wire management must be designed and engineered with these points in mind.

Material Choices

There are two choices for wire management material: metal or plastic. Some solutions utilize both. Most metal wire management solutions are made of stainless steel or a corrosion-resistant spring steel. Proper metal material solutions have the benefit of a long service life, often exceeding the life of the PV array itself.

The downside of metal wire management parts is that metal is conductive. If a cable becomes nicked by the fastener, a short or other type of fault can occur. A cut in the PV cable is more likely if the edges of the metal clip are sharp, not rounded or coined. Another contributing factor is when cables are pulled too tightly against the metal edge of a clip, either through poor installation or inadequate allowance for movement. A cut in the wire is also more likely on a single-axis tracker, as it is tracking during the day, creating a sawing motion and exacerbating any potential rubbing of cable jacket to metal.

Plastic components are also a popular choice. They have the inherent benefit of being non-conductive and, therefore, help mitigate electrical incidences on the array. Plastic is softer and unlikely to slice through a cable jacket. There are many types and grades of plastic available on the market and understanding them is key to choosing the appropriate one for your installation.

Plastic generally does not have the service life of metal but is often chosen as a safer cable management material. Minimizing O&M costs requires choosing plastics engineered for tough solar conditions. Climate and site conditions should be considered in choosing the best possible resin. What are the hot and cold extremes likely to be, is the location dry or humid, will the part be receiving direct or indirect UV exposure? Consult HellermannTyton for the best options for your installation.



In the image above, effort was made to protect the cable jacket from potential abrasion from a metal cable tie. The risk is that this small piece of insulation may erode or slip and leave the cable jacket exposed to the metal tie at an unfortunate angle.

Material Environment Factors:



- Chemicals: These can come from many sources, i.e. weed or dust suppressants.
- UV Exposure: Most of the UV is indirect, but proper UV additives like carbon black and UV stabilizers need to be factored for a long life. A UV rated versus a UV stabilized tie is a drastically different designation. Nylon parts are made appropriate for solar applications in large part by how they hold up to the sun's deleterious effects. Carbon black is a major component that turns the part black and helps to absorb UV radiation. A black, UV rated part can have as little as 0.3 percent carbon black, while a more suitable UV stabilized part will have, at a minimum, 2 percent. HellermannTyton HIRHSUV nylon 66 material can last 3 to 5 times longer in solar environments than a basic black, UV rated tie.



- Galvanization: Galvanized steel releases zinc chloride and other chemicals that can react to plastics. Acid rain can also have an impact. Choosing materials with low or non-hygroscopic properties is important.
- Humidity: Non-hygroscopic materials absorb less moisture, which can help prevent degradation. This factor is becoming more important as the tracker market expands into areas like the Southeastern U.S., where humidity is prevalent, but is an extremely important consideration in all markets.



- Temperature resistance: Plastic engineered for solar applications require a high tolerance for temperature extremes and fluctuations. Heat stabilizing additives are often used to achieve this tolerance and extend the life of plastics at higher temperatures.
- Testing: As new plastics are introduced every year, it is wise to request accelerated testing data to ensure proper material development occurred.



Vinyl-coated, stainless-steel cable ties present another possible solution to wire management. Extreme care must be taken on tracker applications, however. While coated steel parts offer the promise of the stainless steel's long life and durability with the nonconductive insulation of the coating, these parts frequently fail in solar applications. Most failures occur when the coating peels, fades or is rubbed off the steel. This leaves the wires exposed to the metal edge of the cable tie – with the tracker's daily movement increasing the probability of the tie sawing through the wire jacket.

Wire Management Overview

OPTION 1

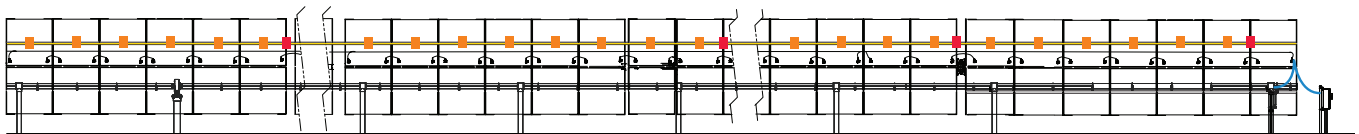

OPTION 2

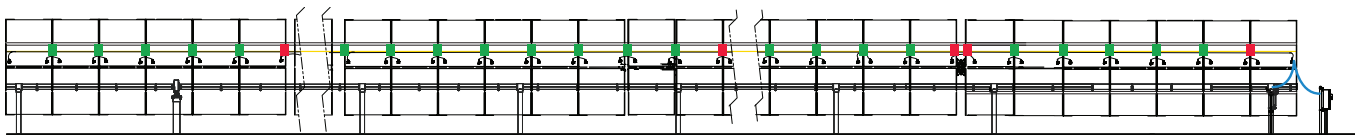

KEY:

■ Ratchet P-Clamp Hanger | Part: 151-02875

■ CTPUV | Part: 904-00357

■ E-Clip | Part: 156-02224 or 156-02225

■ Series 6 Fir Tree Fastener | Part: 157-00421

■ Home Run Bundle

Proper Wire Management Installation Techniques

Manufacturer Installation Guidelines – It is best practice to follow manufacturer installation instructions when installing parts. This helps avoid improper installation and maintains manufacturer product warranties. In addition, always consult manufacturer specifications or electric code with respect to allowable bending radiuses for any conductors. This is also important for bending radiuses of wires emanating from the module junction box.

Proper Sizing/Load Ratings – Wire management solutions come with tensile strength ratings, usually expressed in pounds or newtons. These ratings must be considered as a starting point for determining strength requirements. Solar tracker installations require slack to be left in wires to combat thermal expansion and the transition of moving structure to non-moving structure. This slack presents an opportunity for wind to exert force on cables, increasing the loads on the wire management device. Situations such as birds perching on wires must also be considered. Degradation of the fastening device must also be accounted for; it will not be as strong in 10 or 15 years as it is at the time of installation. Be aware of temperature issues. Ties in extremely hot or cold temperatures will degrade faster. A reasonable safety rating is 3 pounds per foot with a HellermannTyton E-Clip or Series 6 Solar Fastener, but many factors play into your safety rating.

Mounting bases – Running a cable tie through a module hole, while easy, is not a long-term solution. The constant movement of the racking and wires throughout the day creates a sawing effect on the cable tie. A much better option is to use a mounting base, like a fir tree, edge clip or rigid hanger to attach onto the module edge or hole. Having a fully locking tie or clip with a mounting base allows the wire to move throughout the day while fully securing the cabling away from the hole as well.

Strain Relief and Fixing Tension – Wires on solar installations contract and expand throughout the day and are subjected to wind load. Space must be provided for the wires to overcome these near-constant forces. In general, an increase in the number of attachment points and a decrease in the tension on wires provides the best solution. Wires need to move slightly, but too much slack allows the wind to apply greater force on them. Also, over tightening of cable ties can, over time, cut into wire jackets. One best practice is a two-finger approach; leaving a gap of two fingers allows for wire contraction due to thermocycling and helps to avoid over tensioning. Wires floating in a wire management solution can also lead to issues. More slack leaves more opportunity for elements like wind to swing the wires.

Avoid Contact with Metal Structures – Whenever possible, wires should be protected from any metal edge, especially sharp edges. This includes preventing contact with these metal edges in a wind event or when trackers are at any possible angle. It is advisable to include a standoff or a clip that lifts and separates the bundle from direct contact to provide a physical barrier between wires and metal structural components. Often, a properly engineered and UV stabilized piece of convoluted tubing (smurf tube) or split loom (snake skin) may be used to protect the wires. But take extreme care to properly fasten the tubing as, too often, it moves in the field and exposes the wires it was intended to protect.

Other Notes – Many additional precautions must be considered:

- Clip tie ends – avoid situations where a clipped cable tie end can contact the back of the module. While long cable tie tails can be considered ugly, they will do less damage to wires, modules and fingers. Or, use a properly engineered cable tie cutting tool that will leave no sharp edges.
- Prevent wire from contacting the back of the module. This area gets extremely hot and can degrade wire insulation. Also, it can cause hot spots on the module, reducing module efficiency and lifespan.
- Make sure the module's connectors are located in areas where rain, ice and snow will not affect them. Water entering these devices can cause premature failure.

Module Level Wire Management

Single-axis trackers are engineered to minimize excess materials; therefore, there are few structural features to affix wire management parts. Attaching wire to the Series 6 module frame is the most efficient means of properly securing PV cable.

Possible attachment solutions include:

Module Wire Management Hole – Parts designed specifically for the module's mounting hole are highly recommended. It is NOT acceptable to secure PV wires by running cable ties through the module mounting hole. This is one of the most common causes of premature failure on solar installations and an exacerbated problem on single-axis trackers, as the punched hole in a module frame can be sharp and will quickly sever a cable tie, regardless of material. Appropriate options include fir tree fasteners and rigid metal hangers designed to properly fit the module mounting hole. [Ratchet P-Clamp image]

Module Center Brace – The Series 6 module offers a unique feature that is a tremendous benefit to wire management. The center brace is almost directly in line with the wire management hole and could provide a secondary wire management location for Solar E-Clips if additional wire management is needed. The unique design of the center brace does not fit all edge clips, so make sure to compare specification documents before designing. This brace provides a tremendous amount of flexibility in the wire management design process, conveniently providing additional support options when needed near the middle of the module.



The nylon cable tie looped through the module hole is unlikely to last more than a year or two on a single-axis tracker application.

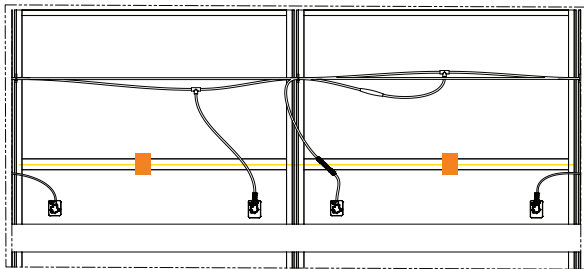
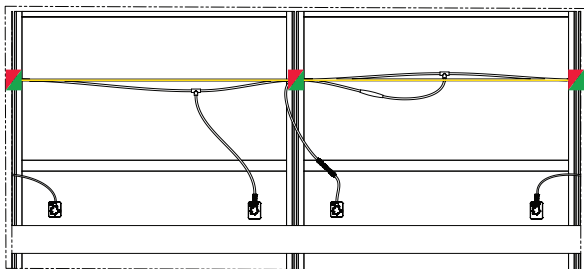

KEY:

- E-Clip | Part: 156-02224 or 156-02225
- Home Run Bundle
- Ratchet PClamp Hanger | Part: 151-02875
- Series 6 Fir Tree Fastener | Part: 157-00421



Part No.
157-00421



Part No.
151-02875



Part No.
156-02224

Tracker-Level Wire Management

End-of-Row Arrest Mechanism — On a single-axis tracker, the most vulnerable area for wire management failure occurs where the string bundle is heaviest or a transition is made to a fixed point. This typically happens at the end of a tracker row or where a jump is made to an adjoining tracker, down to the torque tube, or where the bundle is transitioned to a fixed post.

This is a vulnerable transition for a few reasons. First, the wire bundle is often heaviest (includes home run cables). Second, there is a torsional force on the bundle as its direction changes throughout the day when the tracker moves and changes the direction of downward pressure. Third, a bending force exists as the direction of the bundle has changed to allow it to move from being parallel to the tracker to being perpendicular. An arrest mechanism refers to a heavy duty fastening mechanism designed to provide increased support for this weak point.

A typical failure scenario seen on utility-scale installations is a “zipper” type failure. This occurs when the weakest point breaks and places even greater stress on the next support, causing it to break as well, and so on. The arrest mechanism seeks to minimize this wire management failure point and subsequent catastrophic failure of an entire tracker’s module strings.



Part No.
151-02875



Managing Wire in Transitions

From Module to Torque Tube

Wiring can be fastened to the torque tube as it transitions from the module to either the adjacent row or to the post. This fastening is most often accomplished with a torque tube tie (heavy duty cable tie capable of reaching around the entire torque tube and accommodating the PV bundle) or an affixed clamp. One attachment point could be the bolt for the spacer plate near the module or torque tube or a P-clamp attached with a self-tapping screw. This measure is an effort to minimize the amount of free-floating wire on the array and subsequent damage that might be caused from wind or other forces. A torque tube tie for a typical tracker must be at least 21" long and should have a minimum strength rating of 150 pounds.

Attached to Spacer Plate or Module

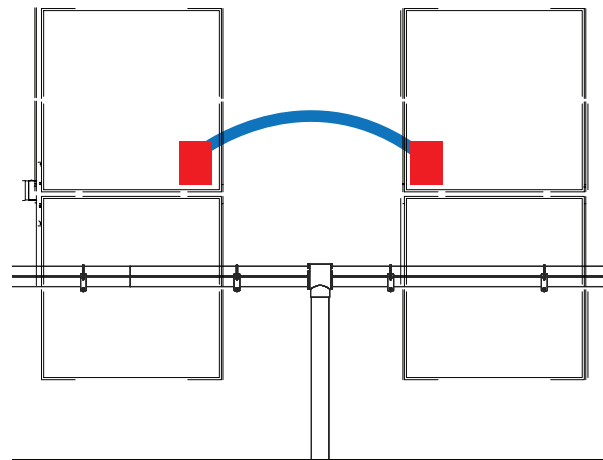

KEY:

- Ratchet P-Clamp Hanger | Part: 151-02875
- CTPUV | Part: 904-00357

From Tracker Row to Next Row

Managing bundles as they jump from one tracker to the next presents unique challenges. Not only is the bundle subjected to tracker movement at the beginning and end of the “jump,” it should be fastened along the post between, which does not move. The wire bundle must also be kept clear of the tracker gearbox and driveline throughout the entire range of tracker rotation. Furthermore, care should be taken to limit places for birds to perch.

An arrest mechanism should be securely fastened to each module adjacent to the gap. This jump is often given extra UV and abrasion protection by using some type of split loom or “snake skin” covering. In this case, the arresting mechanism should securely hold both the wire bundle and the protective covering. Care should be taken to keep water from entering the conduit, or drainage should be provided.

The bundle will then arc down below the gear box and must be held in place on the post. This is often accomplished using a Ratchet P-Clamp. Best practice is to affix the bundle approximately 6" below the gear box. Slack must be left on each side of the tracker to allow for the tracker’s range of motion. Typically, a length of 12" is adequate, but a field test is necessary as conditions change.

Optionally, when a location is subjected to high winds or when more support is required, a torque tube tie between the arrest mechanism and the post support helps reduce potential swing of the looped bundle. This is one option, and each project with this level of need should be evaluated on a case by case basis.

Verify no conduit will obstruct tracker movement. This could cause damage to the conduit and the modules.

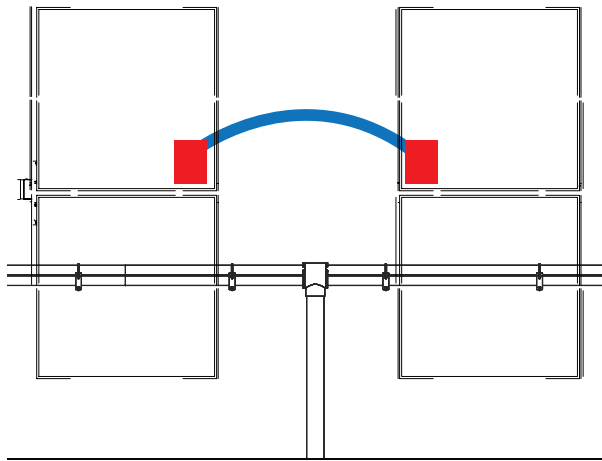
Tracker Row Jumper**KEY:**

■ Ratchet P-Clamp Hanger | Part: 151-02875

■ CTPUV | Part: 904-00357

From Tracker Row to Fixed Post

Drip loops – This works well for controlling water infiltration into raceways or boxes. But drip loops are also sometimes used to provide flexibility when wiring transitions from a moving tracker to a stationary pier. This can be an issue over the long term, as PV and USE wiring have not been tested and rated for continuous movement. Over time, the insulation can crack, exposing the conductors. Proper wire management with appropriate bend radii will minimize wire movement and help combat this issue.

Raceways (Tubing, Conduit, etc.) – This will give you the best protection from damage. The issue is allowing for flexibility while maintaining the integrity of the system and meeting all code requirements. Raceways must be either arranged to drain or protected so water cannot enter them. Water will freeze in colder climates, damaging internal wiring and the raceway. In warmer climates, water can corrode metal and damage wire insulation. According to manufacturer's installation requirements, clamps to attach the raceway are required to be tight enough to prevent slippage, which hinders flexibility. If metal raceways are used, code requires that they be bonded/grounded. This would require bonding.



The tubing used on the wiring in this photo would seem to protect the wires from damage. The long, loose run actually encourages damage from lawn mowing equipment and the wind.

Tracker Row to Fixed Post

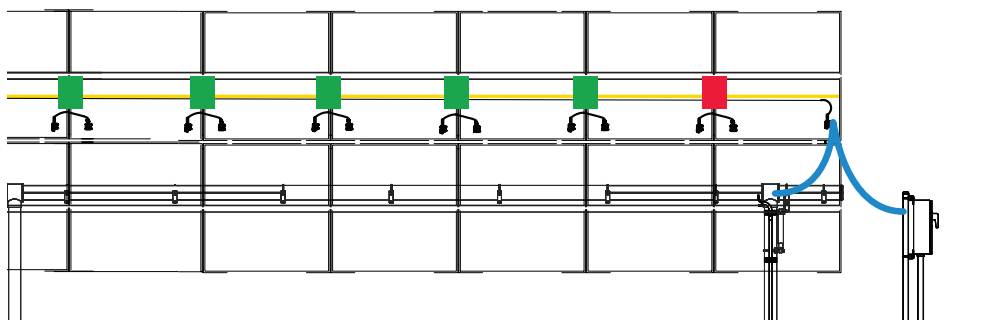
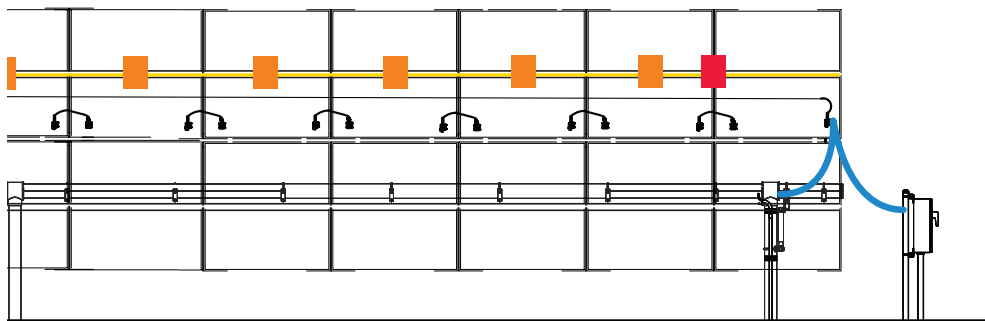

KEY:

- Ratchet P-Clamp | Part: 151-01521
- Home Run Bundle
- CTPUV | Part: 904-00357
- E-Clip | Part: 156-02224 or 156-02225
- Series 6 Fir Tree Fastener | Part: 151-00421

Bundling and Securing

Clamps

Ratchet P-Clamps

Series 6 RCP Hanger

The Series 6 Ratchet P-Clamp Solar Hanger offers one-handed, toolless simplicity and size versatility for managing wires and cables on First Solar modules. The robust design and solar-optimized materials make it ideal for heavy duty, outdoor applications. The one-piece adjustable clamp can be closed by hand to the desired diameter, replacing multiple sizes of fixed diameter fasteners. The integrated release feature enables easy and nondestructive removal of cables by inserting a flat-head screwdriver. This allows the clamp to be reused without removing it. Four sizes accommodate bundles from 1/4" to 2" in diameter.



Features and Benefits

- Impact modified, heat and UV stabilized PA66 provides long-term durability in solar applications.
- One-piece ratchet closure design allows for easy installation during pre- or final assembly.
- Four sizes handle a wide range of diameters, reducing part inventory.
- Release feature allows for quick adjustments and maintenance.
- First Solar specific steel mounting hanger tolerates high torque and is treated to resist chemicals.

MATERIAL	Polyamide 6.6 high impact modified, heat and UV stabilized (PA66HIRHSUV), Zinc plated (ZN)
Operating Temperature	-40°F to +230°F (-40°C to +110°C)

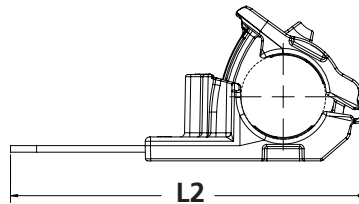
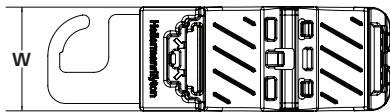

PART NO.	TYPE	Min. Tensile Strength lbs. (N)	Mounting Hole Dia. in. (mm)	Length (L2) in. (mm)	Width (W) in. (mm)	Material	Pkg. Qty.
151-02875	RCBHANGER	100.0 (445.0)	0.2 (5.6)	3.2 (82.3)	1.4 (34.9)	PA66HIRHSUV, ZN	280

Dimensions are approximate and subject to technical changes. Use Part No. for ordering and Type for specification purposes.

Fir Tree Mount Cable Ties

Series 6 Solar Fir Tree Fasteners

The Series 6 Solar Fir Tree Fastener is the easiest and fastest wire management solution on the market. It features a head design specifically tailored for First Solar Series 6 Modules. Entire fir tree passes through wire management hole to prevent unintended disengagement. Unique barrel head rests on module lip to relieve fir tree of downward forces. Offset keeps bundles the perfect distance from mounting hole, allowing nondestructive movement due to wind or tracker motion. The bent tail design allows quick and simple installations by hand.

Features and Benefits

- HIRHSUV solar fasteners provide excellent resistance to UV, chemical and moisture sensitive environments.
- Can be pre-installed while modules are still on the pallet.
- Barrel and offset head design reduces potential for abrasion and wear.
- First Solar vetted design.



MATERIAL	Polyamide 6.6 high impact modified, heat and UV stabilized (PA66HIRHSUV)
Operating Temperature	-40°F to +230°F (-40°C to +110°C)
Flammability	UL 94 HB

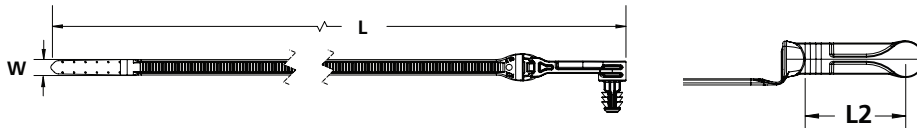

PART NO.	TYPE	Mounting Hole Dia. in. (mm)	Panel Thickness in. (mm)	Offset Length (L2) in. (mm)	Length (L) in. (mm)	Max. Bundle Diameter in. (mm)	Min. Tensile Strength lbs. (N)	Width (W) in. (mm)	Pkg. Qty.
157-00421	T50ROSFT5.6SO25R	0.2 (5.6)	0.2 - 0.2 (3.0 - 4.3)	1.0 (25.0)	8.0 (202.0)	2.0 (50.0)	50.0 (222.0)	0.2 (5.1)	1000

Dimensions are approximate and subject to technical changes. Use Part No. for ordering and Type for specification purposes.



About HellermannTyton

HellermannTyton is a global manufacturer of identification, cable management and connectivity solutions for the commercial data, telecommunications, OEM and industrial markets. HellermannTyton offers an integrated approach to design, operation and delivery to optimize service and solutions for local and global customers. The company's engineered solutions and innovative products are designed and constructed to meet the strictest quality standards while delivering reliable implementation at the lowest cost.

For more information, call HellermannTyton at 800.537.1512 or visit www.hellermann.tyton.com for published details.

HellermannTyton North American Corporate Headquarters

7930 N. Faulkner Rd, PO Box 245017
Milwaukee, WI 53224-9517
Phone: (800) 822-4352
Fax: (414) 355-7341
email: corp@htamericas.com
www.hellermann.tyton.com

**TS16949, ISO 9001, AS9100
and ISO 14001 Certified**

The information contained in this document represents the current view of HellermannTyton with respect to the subject matter contained herein as of the date of the publication. HellermannTyton makes no commitment to keep the information presented up to date and the facts in this document are subject to change without notice. As HellermannTyton must respond to the changing market conditions, HellermannTyton cannot guarantee the accuracy of any information presented after the date of issuance. This document is presented for informational purposes only.

All rights reserved. No part of these pages, either text or image, may be used for any purpose other than personal use. Therefore, reproduction, modification, storage in a retrieval system or retransmission, in any form or by any means, electronic, mechanical or otherwise, for reasons other than personal use, is strictly prohibited without prior written permission.

Copyright 2017. All rights reserved. May not be reproduced without the consent of HellermannTyton.