

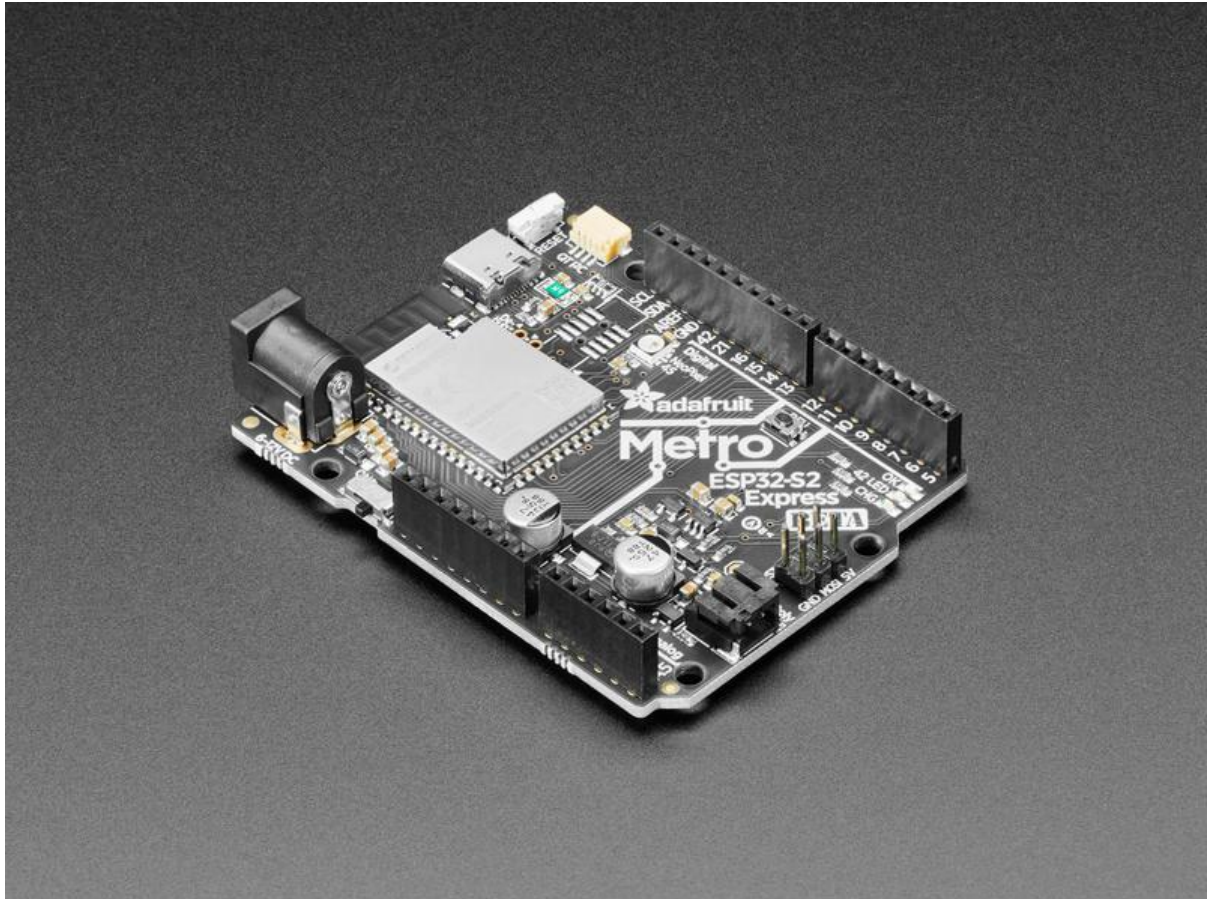

# Adafruit Metro ESP32-S2

Created by Kattni Rembor



<https://learn.adafruit.com/adafruit-metro-esp32-s2>

Last updated on 2023-02-22 12:51:42 PM EST

# Table of Contents

Overview	7
Pinouts	9
<ul style="list-style-type: none"><li>• Power</li><li>• Power Inputs</li><li>• Power Control</li><li>• Power Outputs</li><li>• ESP32-S2 WiFi Module</li><li>• Logic Pins</li><li>• LEDs and NeoPixel</li><li>• STEMMA QT</li><li>• UART Debug</li><li>• Reset and DFU</li><li>• JTAG Debug</li></ul>	
ROM Bootloader	17
<ul style="list-style-type: none"><li>• Enter ROM Bootloader Mode</li><li>• Run esptool and check connection</li></ul>	
Web Serial ESPTool	20
<ul style="list-style-type: none"><li>• Enabling Web Serial</li><li>• Connecting</li><li>• Erasing the Contents</li><li>• Programming the ESP Microcontroller</li></ul>	
Install UF2 Bootloader	25
<ul style="list-style-type: none"><li>• Step 1. Get into the ROM bootloader and install esptool.py</li><li>• Step 2. Download the TinyUF2 release for your board</li><li>• Step 3. Extract the combined.bin file from TinyUF2 release</li><li>• Step 4. Option A) Use esptool.py to upload</li><li>• Step 4 Option B) Use the Web Serial ESPTool to upload</li></ul>	
Welcome To CircuitPython	27
<ul style="list-style-type: none"><li>• This guide will get you started with CircuitPython!</li></ul>	
Installing the Mu Editor	28
<ul style="list-style-type: none"><li>• Download and Install Mu</li><li>• Starting Up Mu</li><li>• Using Mu</li></ul>	
Creating and Editing Code	30
<ul style="list-style-type: none"><li>• Creating Code</li><li>• Editing Code</li><li>• Back to Editing Code...</li><li>• Naming Your Program File</li></ul>	
Connecting to the Serial Console	35
<ul style="list-style-type: none"><li>• Are you using Mu?</li><li>• Serial Console Issues or Delays on Linux</li><li>• Setting Permissions on Linux</li><li>• Using Something Else?</li></ul>	

Interacting with the Serial Console	38
The REPL	41
<ul style="list-style-type: none"><li>• <a href="#">Entering the REPL</a></li><li>• <a href="#">Interacting with the REPL</a></li><li>• <a href="#">Returning to the Serial Console</a></li></ul>	
CircuitPython Libraries	46
<ul style="list-style-type: none"><li>• <a href="#">The Adafruit Learn Guide Project Bundle</a></li><li>• <a href="#">The Adafruit CircuitPython Library Bundle</a></li><li>• <a href="#">Downloading the Adafruit CircuitPython Library Bundle</a></li><li>• <a href="#">The CircuitPython Community Library Bundle</a></li><li>• <a href="#">Downloading the CircuitPython Community Library Bundle</a></li><li>• <a href="#">Understanding the Bundle</a></li><li>• <a href="#">Example Files</a></li><li>• <a href="#">Copying Libraries to Your Board</a></li><li>• <a href="#">Understanding Which Libraries to Install</a></li><li>• <a href="#">Example: ImportError Due to Missing Library</a></li><li>• <a href="#">Library Install on Non-Express Boards</a></li><li>• <a href="#">Updating CircuitPython Libraries and Examples</a></li><li>• <a href="#">CircUp CLI Tool</a></li></ul>	
Advanced Serial Console on Windows	57
<ul style="list-style-type: none"><li>• <a href="#">Windows 7 and 8.1</a></li><li>• <a href="#">What's the COM?</a></li><li>• <a href="#">Install Putty</a></li></ul>	
Advanced Serial Console on Mac	61
<ul style="list-style-type: none"><li>• <a href="#">What's the Port?</a></li><li>• <a href="#">Connect with screen</a></li></ul>	
Frequently Asked Questions	63
<ul style="list-style-type: none"><li>• <a href="#">Using Older Versions</a></li><li>• <a href="#">Python Arithmetic</a></li><li>• <a href="#">Wireless Connectivity</a></li><li>• <a href="#">Asyncio and Interrupts</a></li><li>• <a href="#">Status RGB LED</a></li><li>• <a href="#">Memory Issues</a></li><li>• <a href="#">Unsupported Hardware</a></li></ul>	
ESP32-S2 Bugs & Limitations	68
Troubleshooting	69
<ul style="list-style-type: none"><li>• <a href="#">Always Run the Latest Version of CircuitPython and Libraries</a></li><li>• <a href="#">I have to continue using CircuitPython 5.x or earlier. Where can I find compatible libraries?</a></li><li>• <a href="#">Bootloader (boardnameBOOT) Drive Not Present</a></li><li>• <a href="#">Windows Explorer Locks Up When Accessing boardnameBOOT Drive</a></li><li>• <a href="#">Copying UF2 to boardnameBOOT Drive Hangs at 0% Copied</a></li><li>• <a href="#">CIRCUITPY Drive Does Not Appear or Disappears Quickly</a></li><li>• <a href="#">Device Errors or Problems on Windows</a></li><li>• <a href="#">Serial Console in Mu Not Displaying Anything</a></li><li>• <a href="#">code.py Restarts Constantly</a></li><li>• <a href="#">CircuitPython RGB Status Light</a></li><li>• <a href="#">CircuitPython 7.0.0 and Later</a></li><li>• <a href="#">CircuitPython 6.3.0 and earlier</a></li></ul>	

- [Serial console showing ValueError: Incompatible .mpy file](#)
- [CIRCUITPY Drive Issues](#)
- [Safe Mode](#)
- [To erase CIRCUITPY: storage.erase\\_filesystem\(\)](#)
- [Erase CIRCUITPY Without Access to the REPL](#)
- [For the specific boards listed below:](#)
- [For SAMD21 non-Express boards that have a UF2 bootloader:](#)
- [For SAMD21 non-Express boards that do not have a UF2 bootloader:](#)
- [Running Out of File Space on SAMD21 Non-Express Boards](#)
- [Delete something!](#)
- [Use tabs](#)
- [On MacOS?](#)
- [Prevent & Remove MacOS Hidden Files](#)
- [Copy Files on MacOS Without Creating Hidden Files](#)
- [Other MacOS Space-Saving Tips](#)
- [Device Locked Up or Boot Looping](#)

---

## Welcome to the Community! 88

- [Adafruit Discord](#)
- [CircuitPython.org](#)
- [Adafruit GitHub](#)
- [Adafruit Forums](#)
- [Read the Docs](#)

---

## Install CircuitPython 97

- [Set Up CircuitPython](#)

---

## CircuitPython Pin Names 99

- [Pin Name Diagram](#)

---

## CircuitPython Internet Test 100

- [Secrets File](#)

---

## Getting The Date & Time 104

- [Step 1\) Make an Adafruit account](#)
- [Step 2\) Sign into Adafruit IO](#)
- [Step 3\) Get your Adafruit IO Key](#)
- [Step 4\) Upload Test Python Code](#)

---

## CircuitPython Essentials 108

---

### Blink 108

- [LED Location](#)
- [Blinking an LED](#)

---

### Arduino IDE Setup 110

---

### Using with Arduino IDE 114

- [Blink](#)
- [Select ESP32-S2/S3 Board in Arduino IDE](#)
- [Launch ESP32-S2/S3 ROM Bootloader](#)
- [Load Blink Sketch](#)

---

### WiFi Test 117

- [WiFi Connection Test](#)

- [Secure Connection Example](#)
- [JSON Parsing Demo](#)

## [Usage with Adafruit IO](#) 128

---

- [Install Libraries](#)
- [Adafruit IO Setup](#)
- [Code Usage](#)

## [Debugging with OpenOCD](#) 136

---

- [Metro ESP32S2](#)
- [OpenOCD Setup](#)

## [Downloads](#) 139

---

- [Schematic and Fab Print](#)



---

# Overview

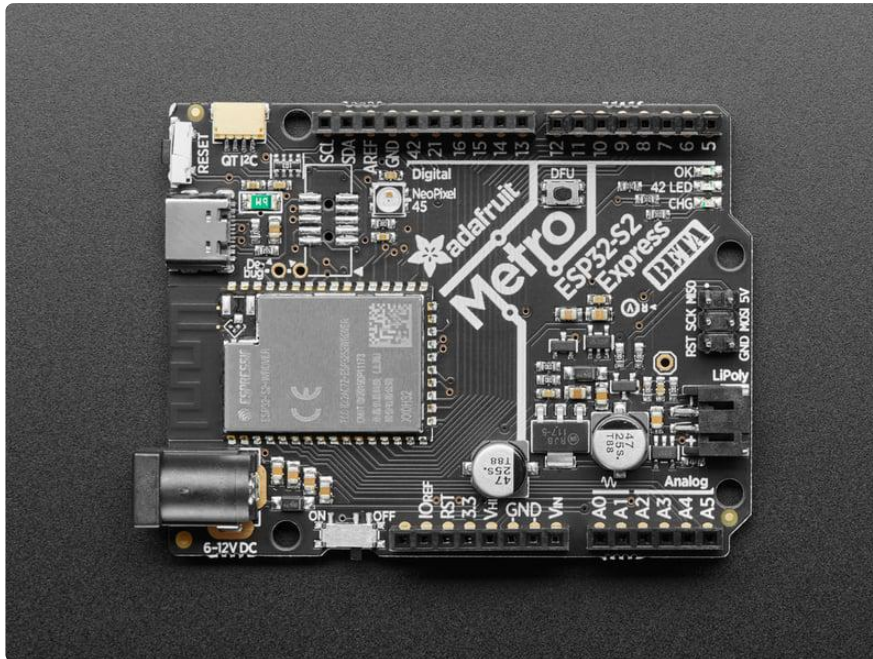

What's Metro shaped and has an ESP32-S2 WiFi module? What has a STEMMA QT connector for I2C devices, and a Lipoly charger circuit? What's finishing up testing and nearly ready for fabrication? That's right - its the new Adafruit Metro ESP32-S2!

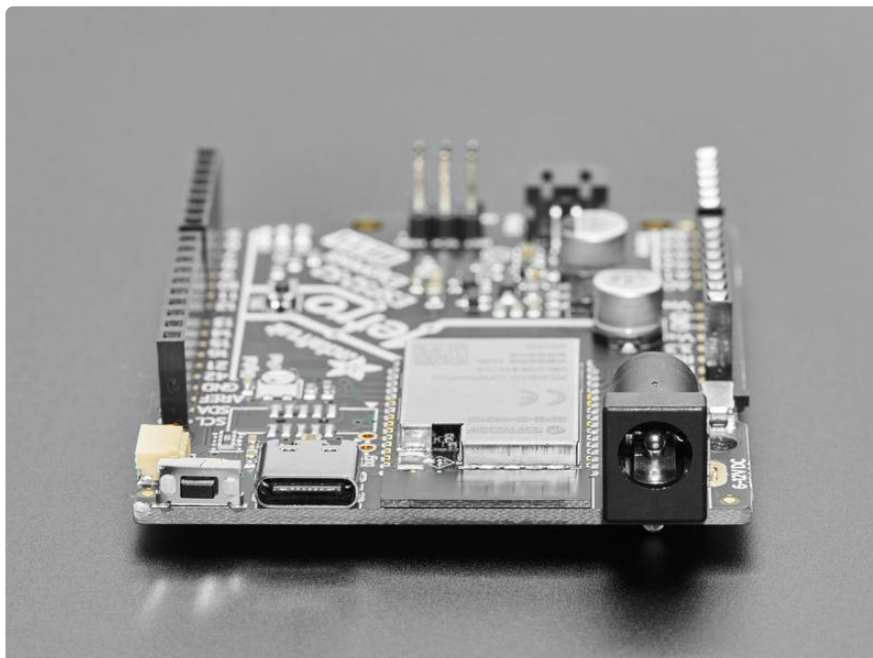

With native USB and a load of PSRAM this board is perfect for use with CircuitPython or Arduino, to add low-cost WiFi while keeping shield-compatibility.

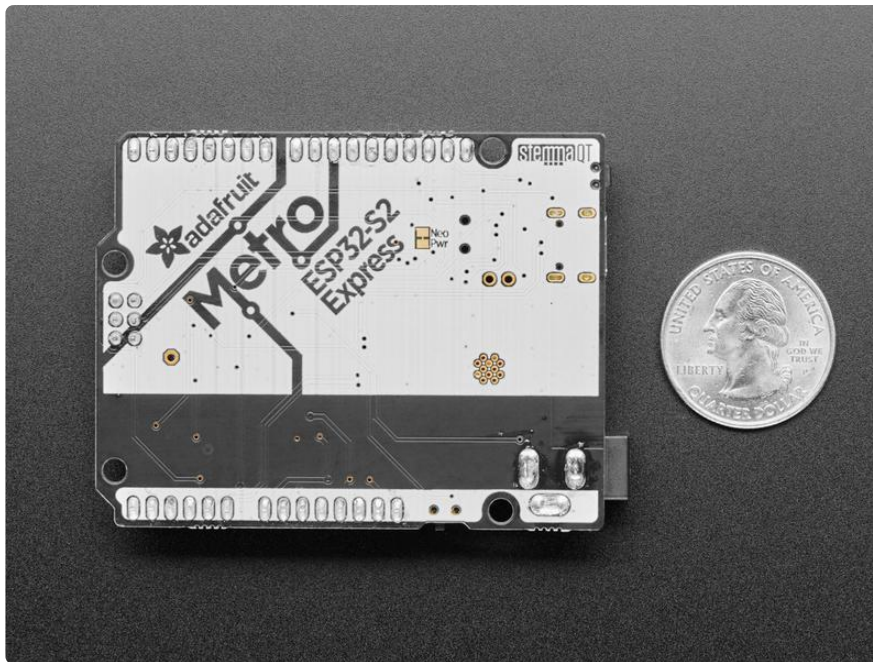

#### Features:

- ESP32-S2 240MHz Tensilica processor - the next generation of ESP32, now with native USB so it can act like a keyboard/mouse, MIDI device, disk drive, etc!
- WROVER module has FCC/CE certification and comes with 4 MByte of Flash and 2 MByte of PSRAM - you can have huge data buffers
- Lotsa power options - 6-12VDC barrel jack or USB type C or Lipoly battery
- Built-in battery charging when powered over DC or USB
- UNO-shape so shields can plug in
- Reset and DFU (BOOT0) buttons to get into the ROM bootloader (which is a USB serial port so you don't need a separate cable!)
- Serial debug pins (optional, for checking the hardware serial debug console)
- JTAG pads for advanced debugging access.
- On/Off switch
- STEMMA QT connector for I2C devices
- On/Charge/User LEDs + status NeoPixel
- Works with Arduino or CircuitPython
- 53.2mm x 72mm / 2" x 2.8"
- Height (w/ barrel jack): 14.8mm / 0.6"
- Weight: 22.5g



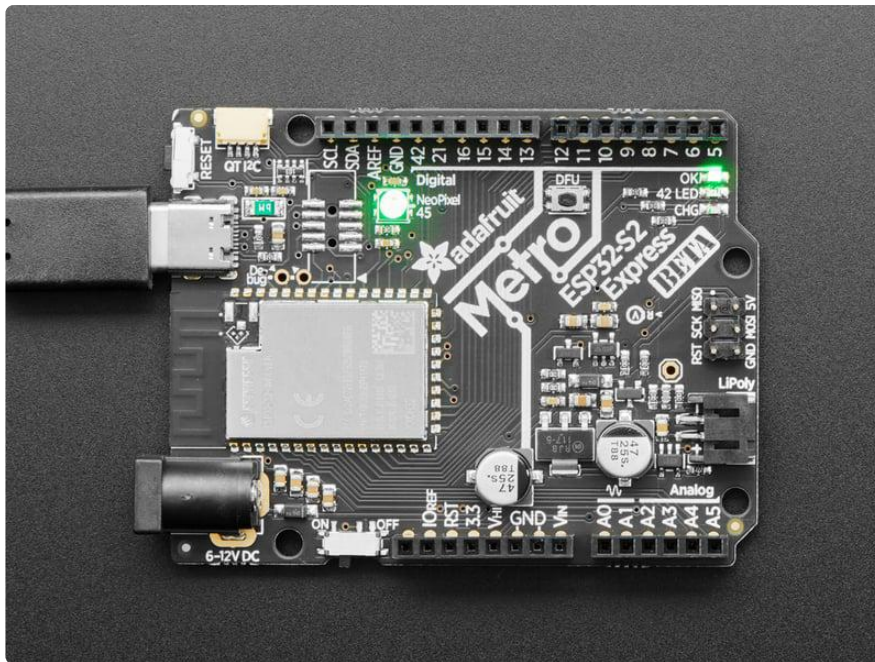

## Pinouts

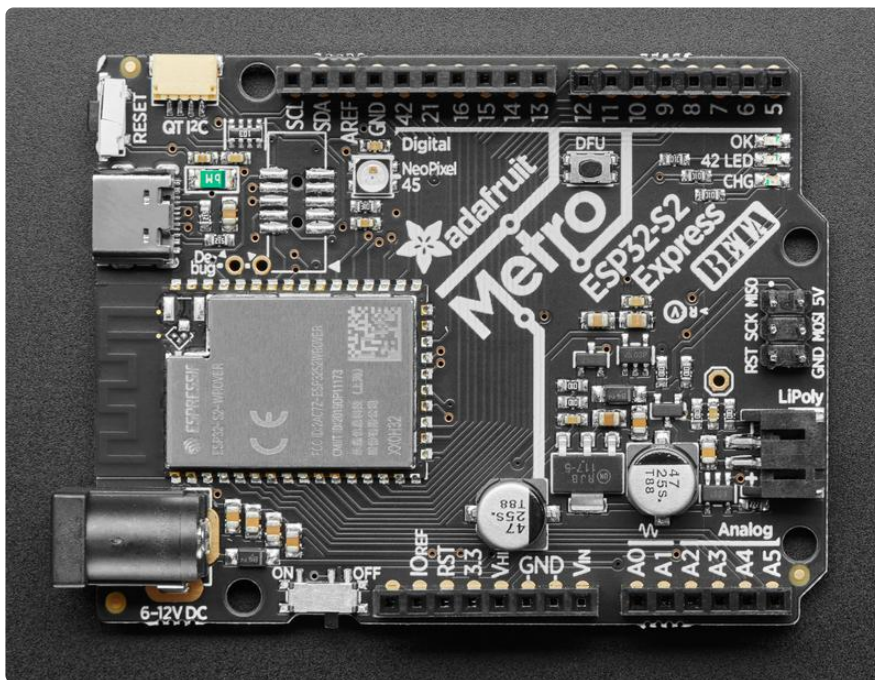

The Metro ESP32-S2 is loaded with all kinds of features. There's lots of pins and ports. Time to take a tour!

# Adafruit Metro ESP32-S2

<https://www.adafruit.com/product/4775>

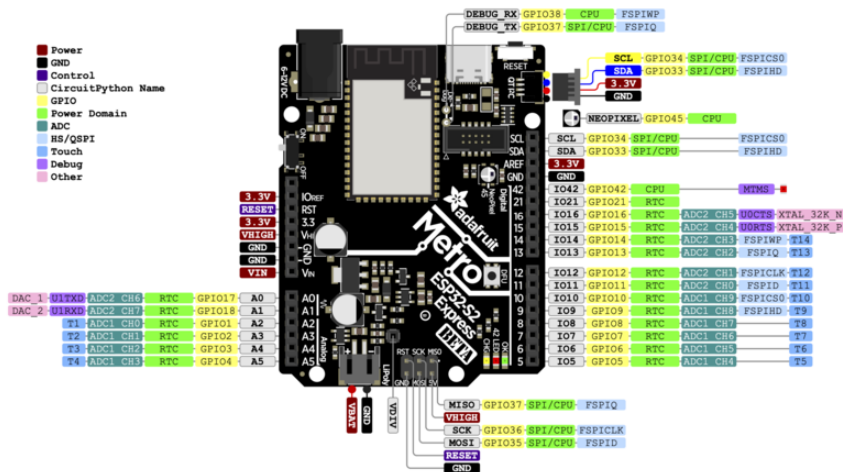

[PDF for Metro ESP32-S2 PrettyPins Diagram \(\)](#)

## Power

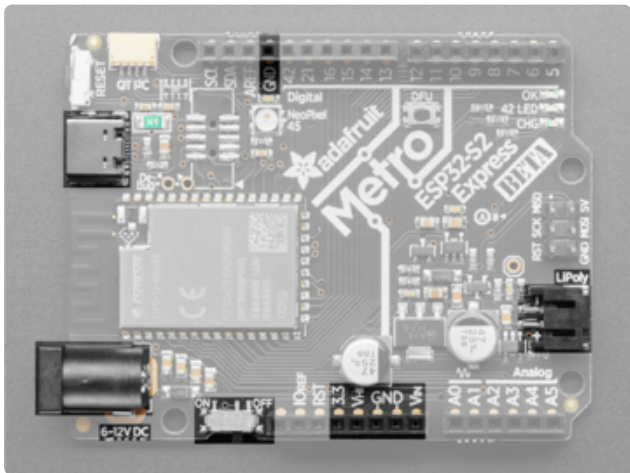

There's a lot of power options available on the Metro ESP32-S2, and they're a little different than most Metro/Arduinos

## Power Inputs

You have three power input options:

- USB C port - This is used for both powering and programming the board. You can power it with any USB C cable and will request 5V from a USB C PD. When USB is plugged in it will charge the Lipoly battery. If there is no battery attached, the yellow LED will flicker (it's looking for a battery!)
- DC barrel jack - The DC Jack is a 5.5mm/2.1mm center-positive DC connector, which is the most common available. Provide about 6V-12V here to power the

Metro. Great for when you have a wall adapter power supply. Don't use a center-negative adapter, it won't work (the OK green LED will not light)

When DC power is plugged in it will charge the Lipoly battery. If there is no battery attached, the yellow LED will flicker (it's looking for a battery!)

If both DC and USB are plugged in, the metro will power itself & recharge the battery from whichever is highest

- LiPoly connector/charger - You can plug in any 250mAh or larger 3.7/4.2V Lipoly battery into this JST 2-PH port to both power your Metro and charge the battery. The battery will charge from the USB or DC power (whichever is plugged in and higher voltage), even if the board is powered off via the switch.

If the battery is plugged in and USB or DC is plugged in, the Metro will power itself from USB or DC and it will charge the battery up.

When the battery is charging, the yellow CHG LED will be lit. When charging is complete, the LED will turn off.

## Power Control

- On/Off switch - This switch controls power to the board. If you plug in your board and nothing happens, make sure the switch is flipped to "ON"! When switched off it will disable the 3.3V power which turns off the ESP32S2 and NeoPixel, but it does not turn off the VHI or VIN pins (see below) and will leave the battery charging.

## Power Outputs

- 3.3V - This is the output pin from the 3.3V regulator, you can grab up to 400mA from this regulator for accessories, it's also used by the ESP32S2 which can have spiky current draw.
- VHI - This pin is usually marked 5V on Arduinos, and when USB or DC is plugged in, it will in fact provide 5V. However, if you have the Metro on LiPo battery power, it will be powered from the battery and thus between 3.7V to 4.2V  
When powered from USB or DC it is regulated to 5V, when powered from battery only, it's not regulated, but it is high-current, great for driving servos and NeoPixels.
- GND - This is the common ground for all power and logic.
- VIN - This is the higher of the DC jack or USB voltage. So if the DC jack is plugged in and 9V, VIN is 9V. If only USB connected, this will be 5V.

# ESP32-S2 WiFi Module

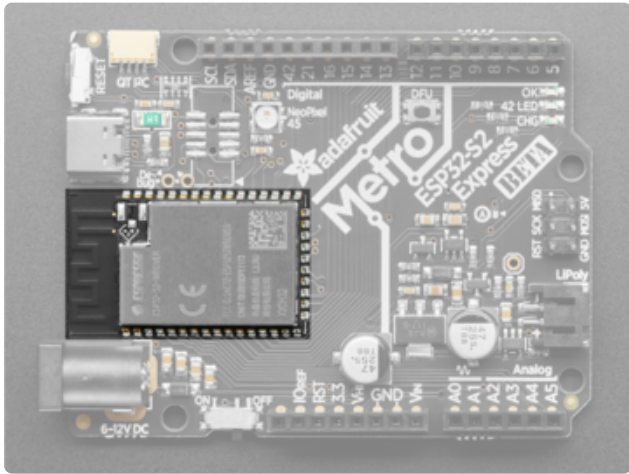

The ESP32-S2 WROVER module.

The ESP32-S2 is a highly-integrated, low-power, 2.4 GHz Wi-Fi System-on-Chip (SoC) solution that now has built-in native USB as well as some other interesting new technologies like Time of Flight distance measurements. With its state-of-the-art power and RF performance, this SoC is an ideal choice for a wide variety of application scenarios relating to the [Internet of Things \(IoT\)](#) (), [wearable electronics](#) (), and smart homes.

Please note, this is a single-core 240 MHz chip so it won't be as fast as ESP32's with dual-core. Also, there is no Bluetooth support. However, we are super excited about the ESP32-S2's native USB which unlocks a lot of capabilities for advanced interfacing! This WROVER module comes with 4 MB flash and 2 MB PSRAM.

The 4 MB of flash is inside the module and is used for both program firmware and filesystem storage. For example, in CircuitPython, we have 3 MB set aside for program firmware (this includes two OTA option spots as well) and a 1MB section for CircuitPython scripts and files.

# Logic Pins

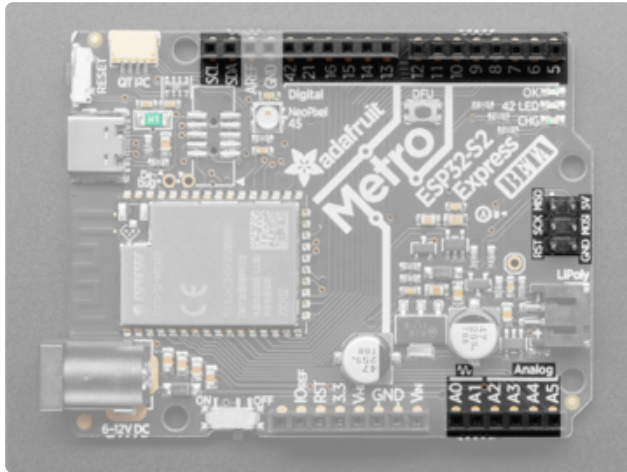

These are the logic pins that can be used to connect shields, sensors, servos, LEDs and more!

No pins are shared, and no pins are 'special' bootstrapping pins, so you can use any of them for input, or output, will pullups or pulldowns, without worry.

ESP32 chips allow for 'multiplexing' of almost all signals so it isn't like some pins can do PWM and others can. You can connect any of the available PWM channels, I2S channels, UART, I2C or SPI ports to any pin. There are some exceptions....

Pin numbers next to pins are the ESP32 IO pin number. E.g. pin 5 is IO5 and 21 is IO21. This is not true for pin names such as A0 thru A5 (these are IO17, IO18, IO1, IO2, IO3, and IO4 in that order), SPI pins (SCK is IO36, MOSI IS IO35 and MISO is IO37) or I2C pins (SDA is IO33 and SCL is IO34)

- A0 and A1 are the only DAC output pins. These can be used as 8-bit true analog outputs. No other pins can do so.
- A0 thru A5, IO5 to IO16 - can also be analog inputs. The labeled SPI port, I2C port and pins 21 and 42 cannot.  
IO11 thru IO16 and A0 plus A1 are on ADC2  
A2 thru A5 plus IO5 thru IO10 are on ADC1  
Check the ESP32-S2 datasheet for the ADC channel names for each pin if you need em!
- The 2x3 SPI pins on the right side of the board is on the ESP32 high speed SPI peripheral - you can set any pins to be the low-speed peripheral but you won't get the speedy interface!
- The SDA/SCL I2C pins have 3.3V pullups on them, and are shared with the STEMMA QT port
- Pin 42 is connected to a red LED and is also shared with the JTAG TMS pin. If you happen to be JTAG debugging, this pin will not be available to you.

- Pin 45 is connected to the NeoPixel and is a special bootstrap pin but we only use it as an output so it doesn't matter that there's a pullup/down on it.

## LEDs and NeoPixel

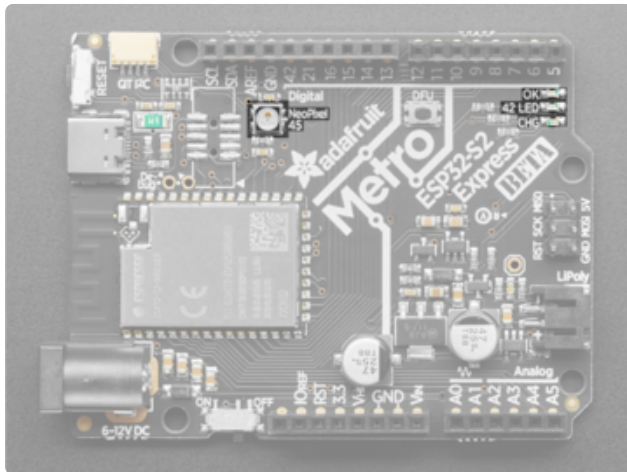

NeoPixel LED - This addressable RGB NeoPixel LED is both a status LED and user controllable on IO45

LED - This red LED on IO42 is user controllable for blinky needs, it is shared with JTAG TMS and cannot be used if you happen to be JTAG decoding.

OK LED - This green LED indicates the board is powered on, it is connected to the 3.3V power supply.

CHG LED - This yellow LED lets you know when the plugged in battery is charging and when it's fully charged. It's normal for this LED to flicker when no battery is in place, that's the charge circuitry trying to detect whether a battery is there or not.

# STEMMA QT

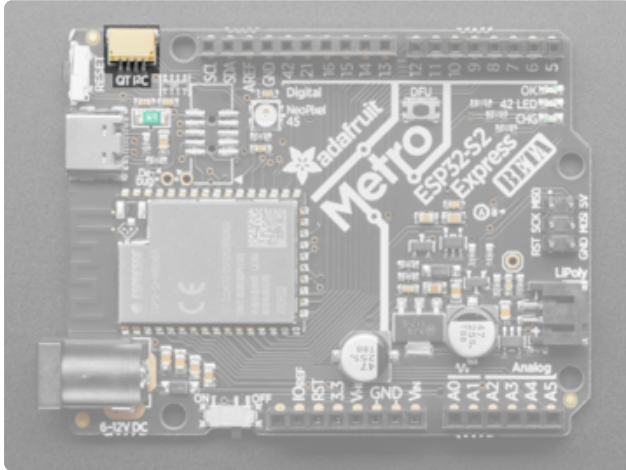

[STEMMA QT \(\)](#) - This JST SH 4-pin connector breaks out I2C (SCL, SDA, 3.3V, GND). It allows you to connect to [various breakouts and sensors with STEMMA QT connectors \(\)](#) or to other things using [assorted associated accessories \(\)](#).

In CircuitPython, you can use the STEMMA connector with `board.SCL` and `board.SDA`, or `board.STEMMA_I2C()`.

Works great with any STEMMA QT or Qwiic sensor/device

[You can also use it with Grove I2C devices thanks to this handy cable \(\)](#)

# UART Debug

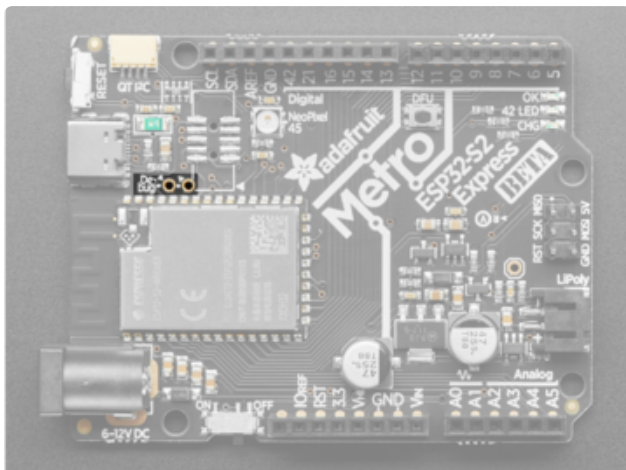

The hardware UART debug port has two broken out pins. [You can connect these to a USB console cable in order to read the debug output from the ESP32 IDF \(\)](#). This is useful if you are writing software and need to see the low level debug output without using JTAG debugging.

This is not where default `Serial.print()` or CircuitPython `print()` outputs go, because those will go through the USB port instead!

# Reset and DFU

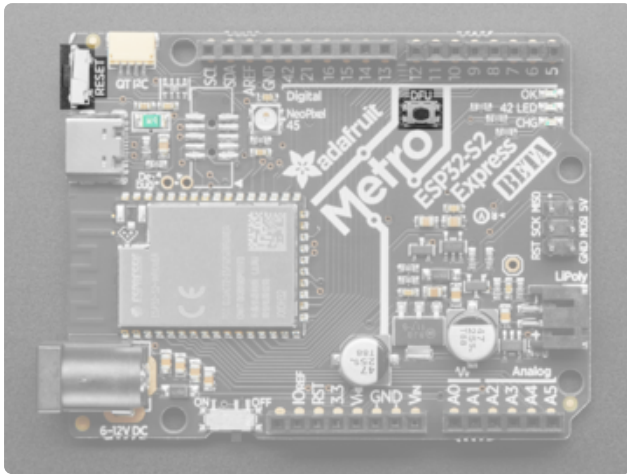

Reset button - The reset button in the top left corner is used to reset the board.  
DFU button - This is connected to BOOT0 and can be used to put the board into ROM bootloader mode. To enter ROM bootloader mode, hold down DFU button while clicking reset button mentioned above. When in the ROM bootloader, you can upload code and query the chip using `esptool`

# JTAG Debug

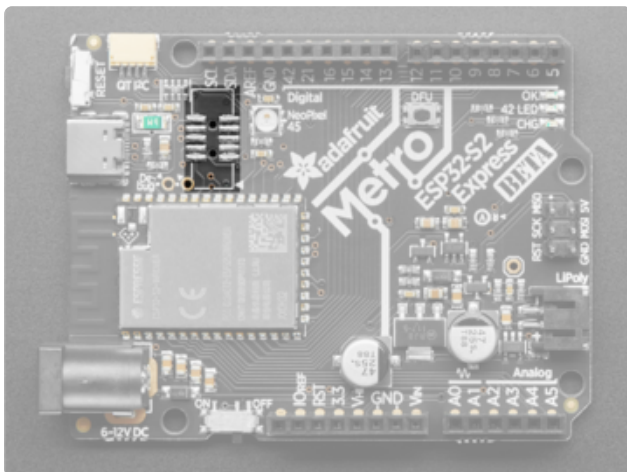

If you'd like to do more advanced development, trace-debugging, or not use the bootloader, we have the JTAG interface exposed. You'll need to solder an [2x5 1.27mm pitch connector](#) () or [Mini 2x5 connector](#) () to your board. A JLink or similar is needed to perform debugging.

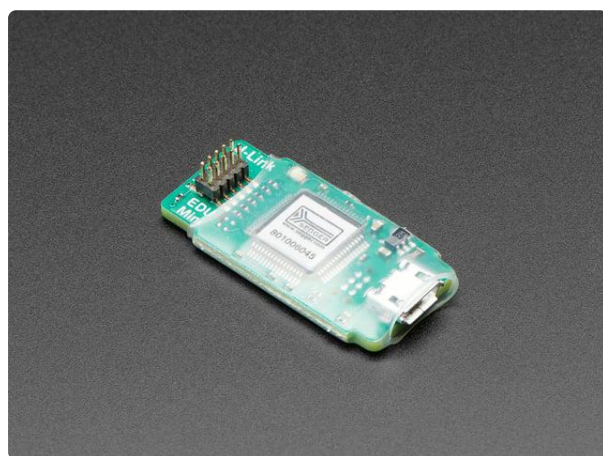

## SEGGER J-Link EDU Mini - JTAG/SWD Debugger

Doing some serious development on any ARM-based platform, and tired of 'printf' plus an LED to debug? A proper JTAG/SWD HW debugger can make debugging more of a pleasure and...

<https://www.adafruit.com/product/3571>



---

# ROM Bootloader

The ESP32-S2 has a built in bootloader, which means you never have to worry about 'bricking' your board. You can use it to load code directly, say CircuitPython or the binary output of an Arduino compilation or you can use it to load a second bootloader on, like UF2 which has a drag-n-drop interface.

The ROM bootloader can never be disabled or erased, so its always there if you need it!

## Enter ROM Bootloader Mode

Entering the bootloader is easy. Complete the following steps.

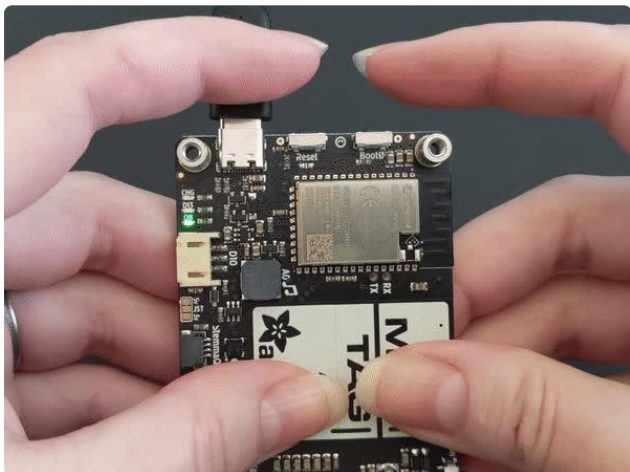
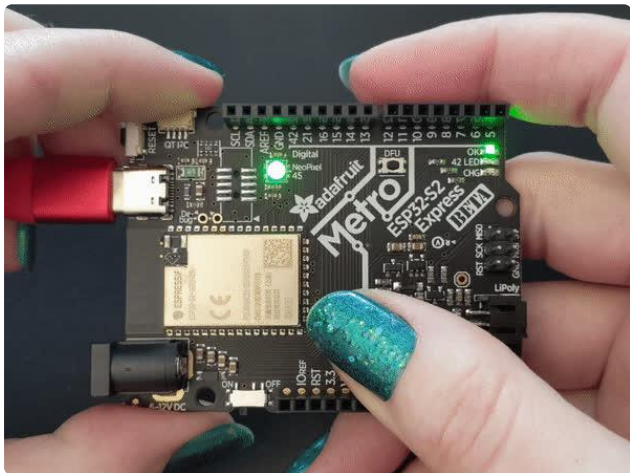

1. Make sure your ESP32-S2 is plugged into USB port to your computer using a data/sync cable. Charge-only cables will not work!
2. Turn on the On/Off switch - check that you see the OK light on so you know the board is powered, a prerequisite!
3. Press and hold the DFU / Boot0 button down. Don't let go of it yet!
4. Press and release the Reset button. You should have the DFU/Boot0 button pressed while you do this.
5. Now you can release the DFU / Boot0 button
6. Check your computer for a new serial / COM port. On windows check the Device manager

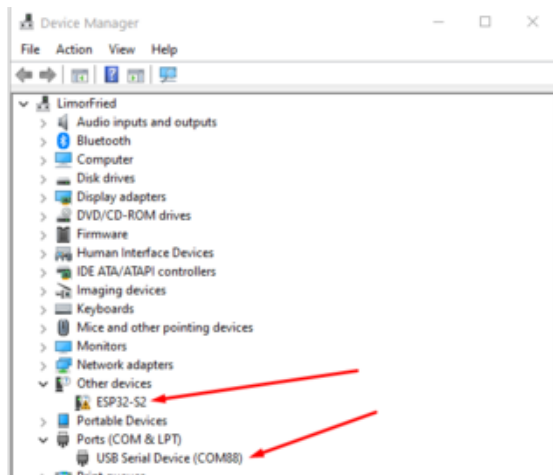

On Windows check the Device manager - you will see a COM port, for example here its COM88. You may also see another "Other device" called ESP32-S2

It's best to do this with no other dev boards plugged in so you don't get confused about which COM port is the ESP32-S2

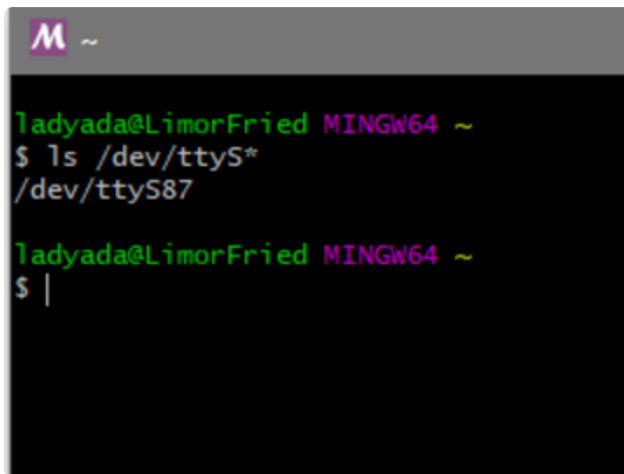

On Mac/Linux you will need to find the tty name which lives under /dev

On Linux, try `ls /dev/ttyS*` for example, to find the matching serial port name. In this case it shows up as `/dev/ttyS87`. If you don't see it listed try `ls /dev/ttyA*` on some Linux systems it might show up like `/dev/ttyACM0`



On Mac, try `ls /dev/cu.usbmodem*` for example, to find the matching serial port name. In this case, it shows up as `/dev/cu.usbmodem01`

It's best to do this with no other dev boards plugged in so you don't get confused about which serial port is the ESP32-S2

## Run esptool and check connection

Once you have entered ROM bootloader mode, you can then [use Espressif's esptool program \(\)](#) to communicate with the chip! `esptool` is the 'official' programming tool and is the most common/complete way to program an ESP chip.

You will need to use the command line / Terminal to install and run `esptool`.

You will also need to have pip and Python installed (any version!)

Install the latest version using pip (you may be able to run `pip` without the `3` depending on your setup):

```
pip3 install --upgrade esptool
```

Then, you can run:

```
esptool.py
```

Run `esptool.py` in a new terminal/command line and verify you get something like the below:

```
C:\Users\ladyada>python3 C:\ESP32\esp-idf\components\esptool_py\esptool\esptool.py
esptool.py v3.0-dev
usage: esptool [-h] [--chip {auto,esp8266,esp32,esp32s2}] [--port PORT] [--baud BAUD]
              [--before {default_reset,no_reset,no_reset_no_sync}]
              [--after {hard_reset,soft_reset,no_reset}] [--no-stub] [--trace]
              [--override-vddsdio [{1.8V,1.9V,OFF}]] [--connect-attempts CONNECT_ATTEMPTS]
              {load_ram,dump_mem,read_mem,write_mem,write_flash,run,image_info,make_image,elf2image,read_mac,chip_id,flash_id,read_flash_status,write_flash_status,read_flash,verify_flash,erase_flash,erase_region,version,get_security_info}
              ...
```

Make sure you are running esptool v 3.0 or higher, which adds ESP32-S2 support

esptool v3.2 has a bug which prevents automatic chip detection. Add the argument `--chip esp32-s2` to your commands if you are getting errors.

Run the following command, replacing the identifier after `--port` with the `COMxx`, `/dev/cu.usbmodemxx` or `/dev/ttySxx` you found above.

```
esptool.py --port COM88 chip_id
```

You should get a notice that it connected over that port and found an ESP32-S2

```
C:\Users\ladyada>python3 C:\ESP32\esp-idf\components\esptool_py\esptool\esptool.py --port COM88 chip_id
esptool.py v3.0-dev
Serial port COM88
Connecting...
Detecting chip type... ESP32-S2
Chip is ESP32-S2
Features: WiFi, ADC and temperature sensor calibration in BLK2 of efuse
Crystal is 40MHz
MAC: 7c:df:a1:00:3f:3e
Uploading stub...
Running stub...
Stub running...
Warning: ESP32-S2 has no Chip ID. Reading MAC instead.
MAC: 7c:df:a1:00:3f:3e
Hard resetting via RTS pin...
ERROR: ESP32-S2 chip was placed into download mode using GPIO0.
esptool.py can not exit the download mode over USB. To run the app, reset the chip manually.
To suppress this error, set --after option to 'no_reset'.
```

You can now upload a binary file with the following command

```
esptool.py --port COM88 --after=no_reset write_flash 0x0 firmware.bin
```

don't forget to change the `--port` name to match, and the file name from `firmware.bin` to whatever the firmware file name is.

For example, I downloaded CircuitPython .bin and programmed it thus:

```
C:\Users\ladyada\Desktop>python3 C:\ESP32\esp-idf\components\esptool_py\esptool\esptool.py --port COM88 --after=no_reset write_flash 0x0 adafruit-circuitpython-adafruit_esp32s2_eink_portal-en_US-20201102-58ce4e1.bin
esptool.py v3.0-dev
Serial port COM88
Connecting..
Detecting chip type... ESP32-S2
Chip is ESP32-S2
Features: WiFi, ADC and temperature sensor calibration in BLK2 of efuse
Crystal is 40MHz
MAC: 7c:df:a1:00:3f:3e
Uploading stub...
Running stub...
Stub running...
Configuring flash size...
Auto-detected Flash size: 4MB
Compressed 1304816 bytes to 843841...
Wrote 1304816 bytes (843841 compressed) at 0x00000000 in 25.1 seconds (effective 416.6 kbit/s)...
Hash of data verified.
Leaving...
Staying in bootloader.
```

Once the data is verified, press the Reset button once more to launch the code you just programmed in!

---

## Web Serial ESPTool

The WebSerial ESPTool was designed to be a web-capable option for programming Espressif ESP family microcontroller boards that have a serial based ROM bootloader. It allows you to erase the contents of the microcontroller and program up to 4 files at different offsets.

For boards that lack native USB, like the ESP32 or ESP32-C3 microcontroller, this is how any firmware like CircuitPython .bin files can be loaded. There is no drag-and-drop to a folder option for these boards.

For boards with native USB, like ESP32-S2, -S3, etc. this is how the UF2 bootloader .bin file can be loaded. Once the UF2 bootloader is on, firmware like CircuitPython .uf2 files can be drag-and-dropped to a BOOT folder.

This tool is a good alternative for folks who cannot run Python `esptool.py` on their computer or are having difficulty installing or using `esptool.py`

## Enabling Web Serial



You will have to use the Chrome or Chromium-based browser for this to work. For example, Edge and Opera are Chromium (). Safari and Firefox, etc are not supported - they have not implemented Web Serial ()!

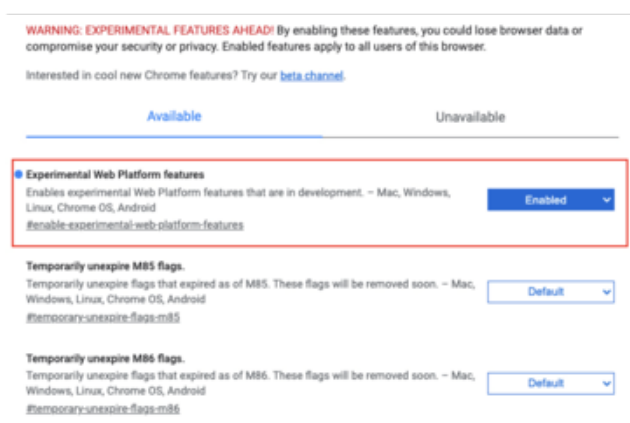

If you have a very old version of Chrome, you'll need to enable the Serial API, which is really easy.

Visit `chrome://flags` from within Chrome. Find and enable the Experimental Web Platform features

Restart Chrome

## Connecting

Before you can use the tool, you will need to put your board in bootloader mode and connect. Here are the steps:

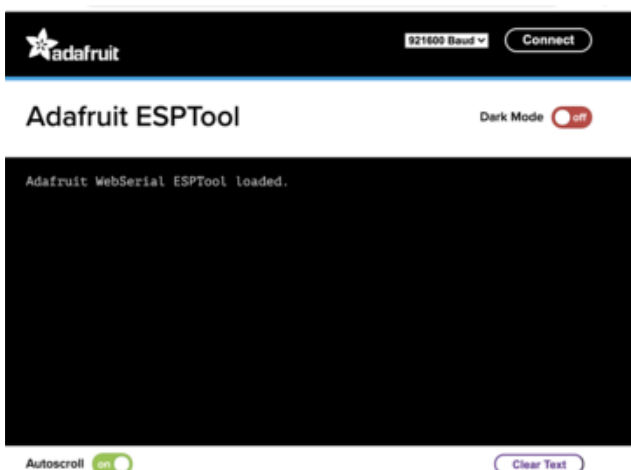

In the Chrome browser visit [https://adafruit.github.io/Adafuit\\_WebSerial\\_ESPTool/](https://adafruit.github.io/Adafuit_WebSerial_ESPTool/) (). You should see something like the image shown.

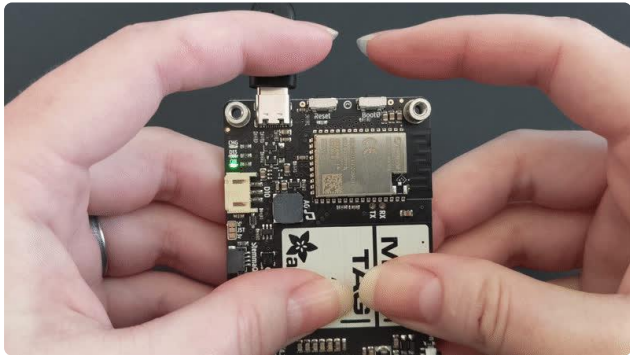

For all ESP32-family boards, you can enter the ROM bootloader by holding down the BOOT button while clicking RST.

If you have an ESP32 board without BOOT (say because its an original ESP32, not -S2 or -S3, etc) you can skip this step because there's an auto-boot circuit.

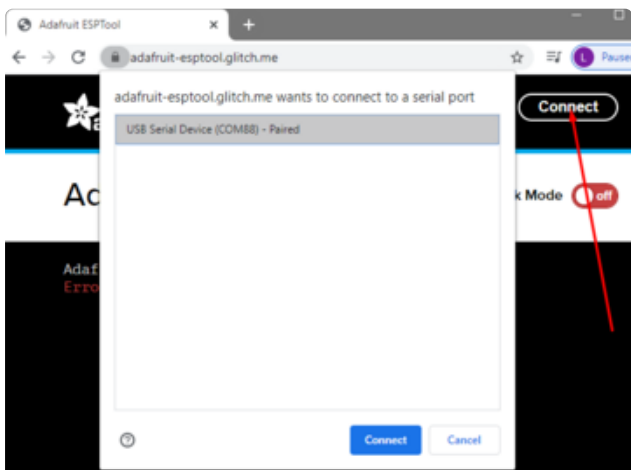

Press the Connect button in the top right of the web browser. You will get a pop up asking you to select the COM or Serial port. Look for something with ESP32, JTAG Loader, SLAB, or FTDI in the name.

Remember, you should remove all other USB devices so only the target board is attached, that way there's no confusion over multiple ports!

On some systems, such as MacOS, there may be additional system ports that appear in the list.

```
ESP Web Flasher loaded.
Connecting...
Connected successfully.
Try hard reset.
Chip type ESP32-S2
Connected to ESP32-S2
MAC Address: 7C:DF:A1:06:8D:D0
Uploading stub...
Running stub...
Stub is now running...
Detecting Flash Size
FlashId: 0x164020
Flash Manufacturer: 20
Flash Device: 4016
Auto-detected Flash size: 4MB
```

The Javascript code will now try to connect to the ROM bootloader. It may timeout for a bit until it succeeds. On success, you will see that it is Connected and will print out a unique MAC address identifying the board along with other information that was detected.

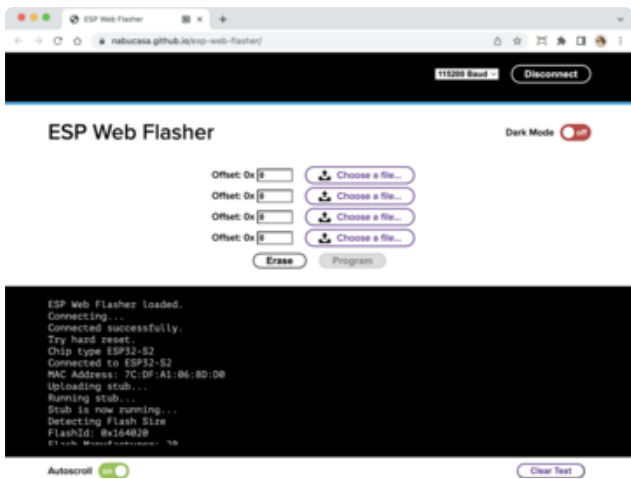

Once you have successfully connected, the command toolbar will appear.

## Erasing the Contents

If you would like to erase the entire flash area so that you can start with a clean slate, you can use the erase feature. We recommend doing this if you are having issues.



To erase the contents, click the Erase button. You will be prompted whether you want to continue. Click OK to continue or if you changed your mind, just click cancel.

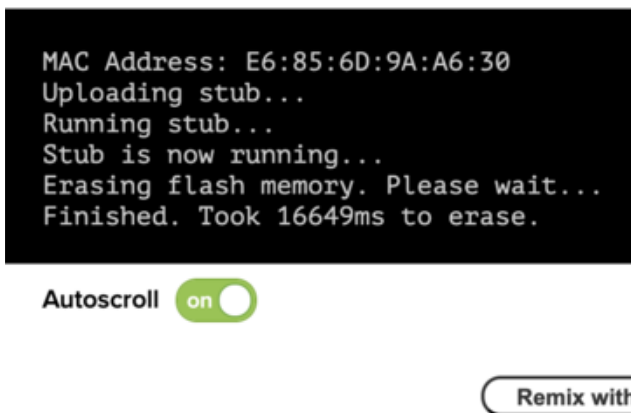

You'll see "Erasing flash memory. Please wait..." This will eventually be followed by "Finished." and the amount of time it took to erase.

Do not disconnect! Immediately continue on to Programming the ESP Microcontroller.

# Programming the ESP Microcontroller

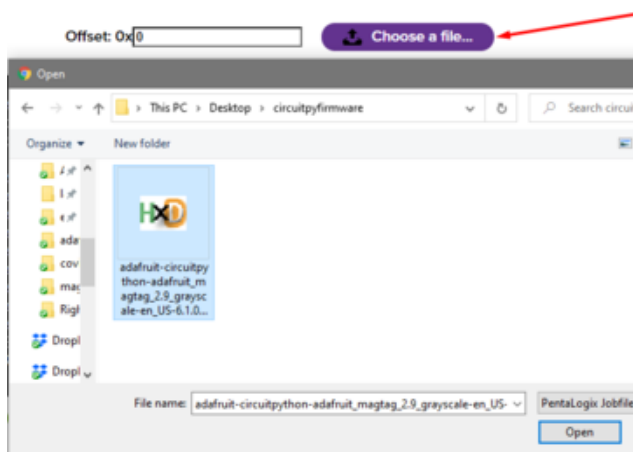

You can click on Choose a file... from any of the available buttons. It will only attempt to program buttons with a file and a unique location. Then select the .bin file(s) - not the UF2 file!

Verify that the Offset box next to the file location you used is 0x0.

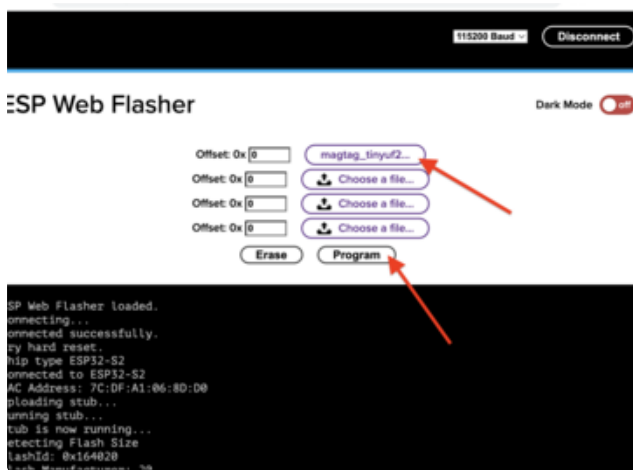

Once you choose a file, the button text will change to match your filename. You can then select the Program button to start flashing.

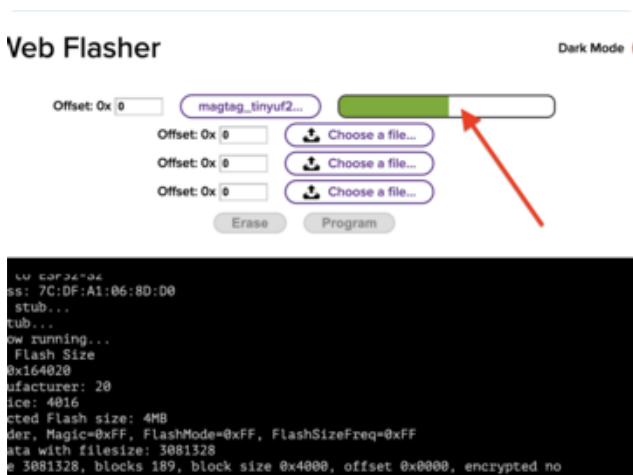

A progress bar will appear and after a minute or two, you will have written the firmware.

After using the tool, press the reset button to get out of bootloader mode and launch the new firmware!



For boards lacking native USB, like the ESP32 and ESP32-C3, no folder will show up after pressing reset. If CircuitPython firmware was loaded, the REPL can be accessed over a serial COM port.

For other boards, like ESP32-S2, -S3, etc., a BOOT folder should show up. A [CircuitPython UF2 \(\)](#) file can now be copied over to the BOOT folder, after which the CIRCUITPY folder should then show up.

---

## Install UF2 Bootloader

If you're familiar with our other products and chipsets you may be familiar with our drag-n-drop bootloader, a.k.a UF2. We have a UF2 bootloader for the ESP32-S2, that will let you drag firmware on/off a USB disk drive

Unlike the M0 (SAMD21) and M4 (SAMD51) boards, there is no bootloader protection for the UF2 bootloader. That means it is possible to erase or damage the bootloader, especially if you upload Arduino sketches to ESP32S2 boards that doesn't "know" there's a bootloader it should not overwrite!

However, thanks to the ROM bootloader, you don't have to worry about it if the UF2 bootloader is damaged. You can simply re-load the UF2 bootloader (USB-disk-style) with the ROM bootloader (non-USB-drive)

Installing a new bootloader will erase your board! Be sure to back up your data first.

### Step 1. Get into the ROM bootloader and install esptool.py

[See the previous page on how to do that! \(\)](#)

### Step 2. Download the TinyUF2 release for your board

Choose the right release file from the list below. If your board is not explicitly mentioned, find it in the "all boards" link. These links are to .zip files.

Latest MagTag TinyUF2 release

Latest Metro ESP32-S2 TinyUF2  
release

Latest Adafruit FunHouse TinyUF2  
release

Look here if your board is not one of the ones above:

Latest TinyUF2 release for all  
boards

### Step 3. Extract the combined.bin file from TinyUF2 release

The file you downloaded in Step 2 is a .zip file. Unzip it and find the combined.bin file. Note that this file is 3MB but that's because the bootloader is near the end of the available flash. It's not actually 3MB of program: most of the file is empty but it's easier to program if we give you one combined 'swiss cheese' file. Save this file to your desktop or wherever you plan to run `esptool` from.

### Step 4. Option A) Use esptool.py to upload

- Put the board into bootloader mode (hold down BOOT0/DFU and click reset)
- Determine the serial or COM port of the board

Run this command and replace the serial port name with your matching port and the file you just downloaded

```
esptool.py -p COM88 write_flash 0x0 combined.bin
```

There might be a bit of a 'wait' when programming, where it doesn't seem like its working. Give it a minute, it has to erase the old flash code which can cause it to seem like its not running.

You'll finally get an output like this:

```
esptool.py v3.0-dev
Serial port COM88
Connecting...
Detecting chip type... ESP32-S2
Chip is ESP32-S2
Features: WiFi, ADC and temperature sensor calibration in BLK2 of efuse
Crystal is 40MHz
MAC: 7c:df:a1:05:f8:9a
Uploading stub...
Running stub...
Stub running...
Configuring flash size...
Auto-detected Flash size: 4MB
Compressed 3081264 bytes to 98937...
Wrote 3081264 bytes (98937 compressed) at 0x00000000 in 22.8 seconds (effective 1080.0 kbit/s)...
Hash of data verified.

Leaving...
Hard resetting via RTS pin...
ERROR: ESP32-S2 chip was placed into download mode using GPIO0.
esptool.py can not exit the download mode over USB. To run the app, reset the chip manually.
To suppress this error, set --after option to 'no_reset'.
```

Click RESET button to launch the bootloader. You'll see a new disk drive on your computer with the name MAGTAGBOOT or similar

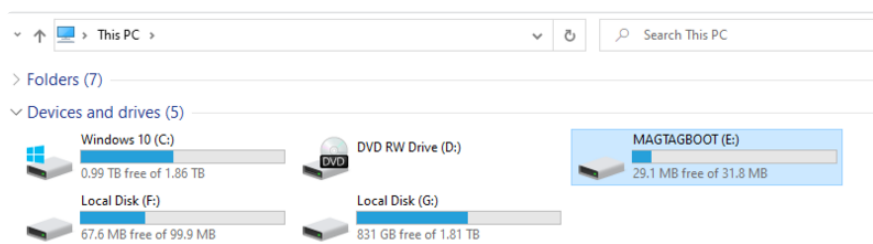

## Step 4 Option B) Use the Web Serial ESPTool to upload

Another option if you are having trouble getting ESPTool running, is to use the [Web Serial ESPTool \(\)](#) in this guide. This tool uses Web Serial to erase or upload firmware to your board.

# Welcome To CircuitPython



So, you've got a new CircuitPython compatible board. You plugged it in. Maybe it showed up as a disk drive called CIRCUITPY. Maybe it didn't! Either way, you need to know where to go from here. Well, this guide has you covered!

## This guide will get you started with CircuitPython!

There are many amazing things about your new board. One of them is the ability to run CircuitPython. You may have seen that name on the [Adafruit site](#) () somewhere. Not sure what it is? This guide can help!

"But I've never coded in my life. There's no way I do it!" You absolutely can! CircuitPython is designed to help you learn from the ground up. If you're new to everything, this is the place to start!

This guide will walk you through how to get started with CircuitPython. You'll learn how to install CircuitPython, get updated to the newest version of CircuitPython, setup a serial connection, and edit your code. You'll learn some basics of how CircuitPython works, and about the CircuitPython libraries. You'll also find a list of frequently asked questions, and a series of troubleshooting steps if you run into any issues.

Welcome to CircuitPython!

---

## Installing the Mu Editor

Mu is a simple code editor that works with the Adafruit CircuitPython boards. It's written in Python and works on Windows, MacOS, Linux and Raspberry Pi. The serial console is built right in so you get immediate feedback from your board's serial output!

Mu is our recommended editor - please use it (unless you are an experienced coder with a favorite editor already!).

## Download and Install Mu



Download Mu from <https://codewith.mu> ().

Click the Download link for downloads and installation instructions.

Click Start Here to find a wealth of other information, including extensive tutorials and and how-to's.

Windows users: due to the nature of MSI installers, please remove old versions of Mu before installing the latest version.

Ubuntu users: Mu currently (checked May 4, 2022) does not install properly on Ubuntu 22.04. See <https://github.com/mu-editor/mu/issues> to track this issue. See <https://learn.adafruit.com/welcome-to-circuitpython/recommended-editors> and <https://learn.adafruit.com/welcome-to-circuitpython/pycharm-and-circuitpython> for other editors to use.

## Starting Up Mu

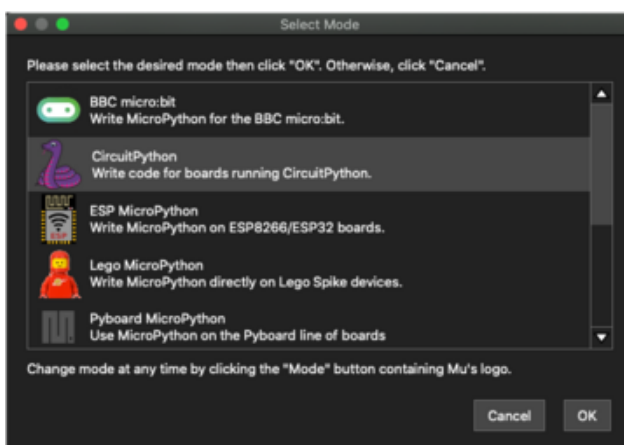

The first time you start Mu, you will be prompted to select your 'mode' - you can always change your mind later. For now please select CircuitPython!

The current mode is displayed in the lower right corner of the window, next to the "gear" icon. If the mode says "Microbit" or something else, click the Mode button in the upper left, and then choose "CircuitPython" in the dialog box that appears.

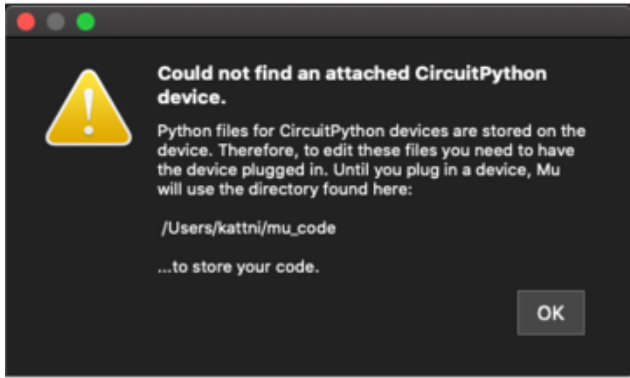

Mu attempts to auto-detect your board on startup, so if you do not have a CircuitPython board plugged in with a CIRCUITPY drive available, Mu will inform you where it will store any code you save until you plug in a board.

To avoid this warning, plug in a board and ensure that the CIRCUITPY drive is mounted before starting Mu.

## Using Mu

You can now explore Mu! The three main sections of the window are labeled below; the button bar, the text editor, and the serial console / REPL.

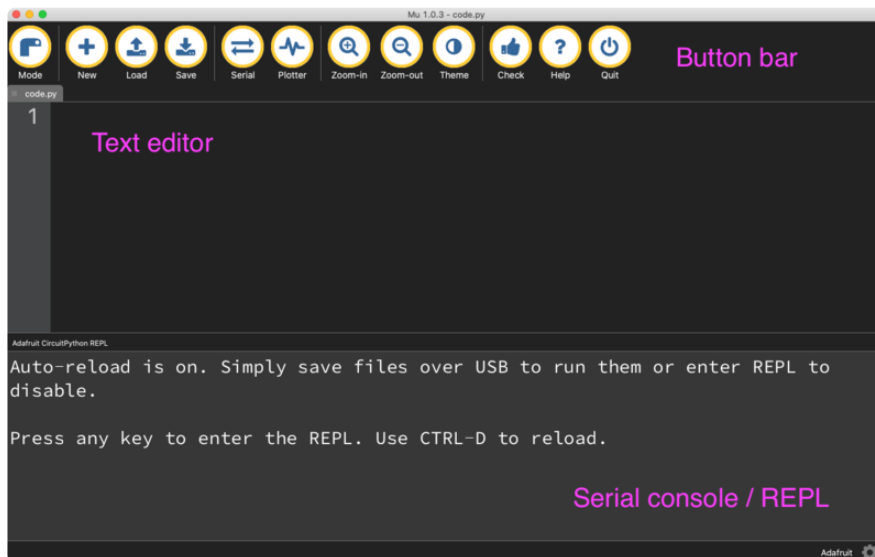

Now you're ready to code! Let's keep going...

---

## Creating and Editing Code

One of the best things about CircuitPython is how simple it is to get code up and running. This section covers how to create and edit your first CircuitPython program.

To create and edit code, all you'll need is an editor. There are many options. Adafruit strongly recommends using Mu! It's designed for CircuitPython, and it's really simple and easy to use, with a built in serial console!

If you don't or can't use Mu, there are a number of other editors that work quite well. The [Recommended Editors page \(\)](#) has more details. Otherwise, make sure you do "Eject" or "Safe Remove" on Windows or "sync" on Linux after writing a file if you aren't using Mu. (This is not a problem on MacOS.)

## Creating Code

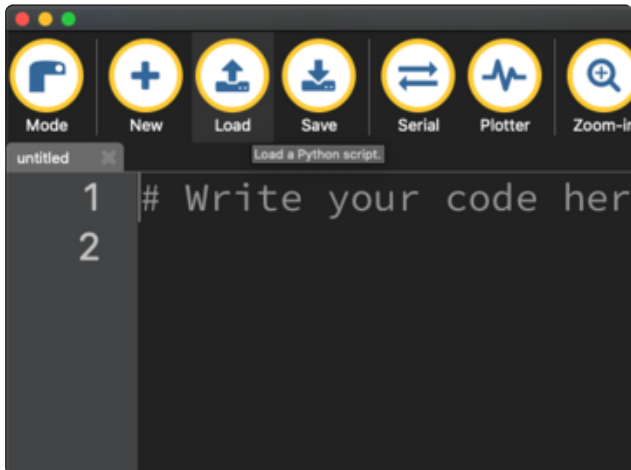

Installing CircuitPython generates a code.py file on your CIRCUITPY drive. To begin your own program, open your editor, and load the code.py file from the CIRCUITPY drive.

If you are using Mu, click the Load button in the button bar, navigate to the CIRCUITPY drive, and choose code.py.

Copy and paste the following code into your editor:

```
import board
import digitalio
import time

led = digitalio.DigitalInOut(board.LED)
led.direction = digitalio.Direction.OUTPUT

while True:
    led.value = True
    time.sleep(0.5)
    led.value = False
    time.sleep(0.5)
```

The KB2040, QT Py and the Trinkeys do not have a built-in little red LED! There is an addressable RGB NeoPixel LED. The above example will NOT work on the KB2040, QT Py or the Trinkeys!

If you're using a KB2040, QT Py or a Trinkey, please download the [NeoPixel blink example \(\)](#).

The NeoPixel blink example uses the onboard NeoPixel, but the time code is the same. You can use the linked NeoPixel Blink example to follow along with this guide page.

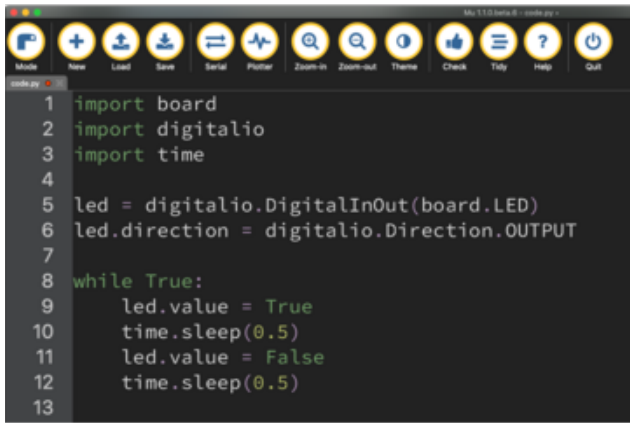

```
1 import board
2 import digitalio
3 import time
4
5 led = digitalio.DigitalInOut(board.LED)
6 led.direction = digitalio.Direction.OUTPUT
7
8 while True:
9     led.value = True
10    time.sleep(0.5)
11    led.value = False
12    time.sleep(0.5)
13
```

It will look like this. Note that under the `while True:` line, the next four lines begin with four spaces to indent them, and they're indented exactly the same amount. All the lines before that have no spaces before the text.

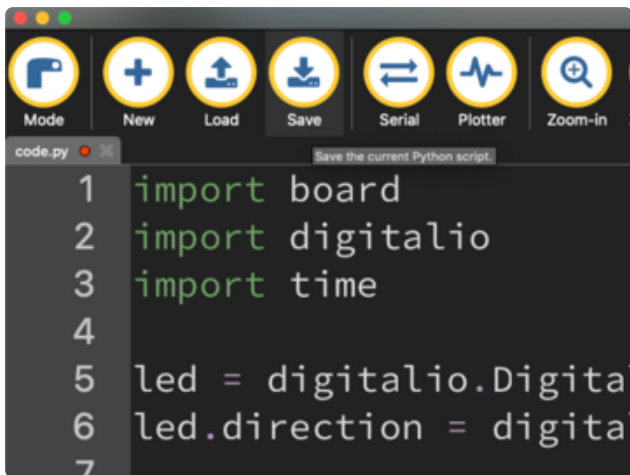

```
1 import board
2 import digitalio
3 import time
4
5 led = digitalio.Digital
6 led.direction = digita
7
```

Save the code.py file on your CIRCUITPY drive.

The little LED should now be blinking. Once per half-second.

Congratulations, you've just run your first CircuitPython program!

On most boards you'll find a tiny red LED.

On the ItsyBitsy nRF52840, you'll find a tiny blue LED.

On QT Py M0, QT Py RP2040, and the Trinkey series, you will find only an RGB NeoPixel LED.



## Editing Code

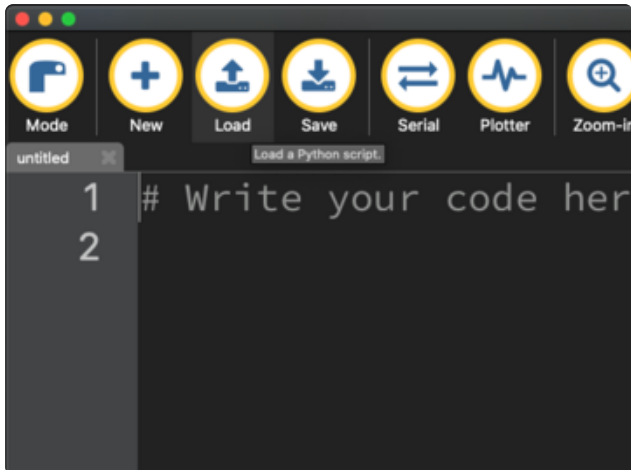

To edit code, open the code.py file on your CIRCUITPY drive into your editor.

Make the desired changes to your code. Save the file. That's it!

Your code changes are run as soon as the file is done saving.

There's one warning before you continue...

**Don't click reset or unplug your board!**

The CircuitPython code on your board detects when the files are changed or written and will automatically re-start your code. This makes coding very fast because you save, and it re-runs. If you unplug or reset the board before your computer finishes writing the file to your board, you can corrupt the drive. If this happens, you may lose the code you've written, so it's important to backup your code to your computer regularly.

There are a couple of ways to avoid filesystem corruption.

1. Use an editor that writes out the file completely when you save it.

Check out the [Recommended Editors page \(\)](#) for details on different editing options.

If you are dragging a file from your host computer onto the CIRCUITPY drive, you still need to do step 2. Eject or Sync (below) to make sure the file is completely written.

## 2. Eject or Sync the Drive After Writing

If you are using one of our not-recommended-editors, not all is lost! You can still make it work.

On Windows, you can Eject or Safe Remove the CIRCUITPY drive. It won't actually eject, but it will force the operating system to save your file to disk. On Linux, use the sync command in a terminal to force the write to disk.

You also need to do this if you use Windows Explorer or a Linux graphical file manager to drag a file onto CIRCUITPY.

---

## Oh No I Did Something Wrong and Now The CIRCUITPY Drive Doesn't Show Up!!!

Don't worry! Corrupting the drive isn't the end of the world (or your board!). If this happens, follow the steps found on the [Troubleshooting \(\)](#) page of every board guide to get your board up and running again.

---

## Back to Editing Code...

Now! Let's try editing the program you added to your board. Open your code.py file into your editor. You'll make a simple change. Change the first `0.5` to `0.1`. The code should look like this:

```
import board
import digitalio
import time

led = digitalio.DigitalInOut(board.LED)
led.direction = digitalio.Direction.OUTPUT

while True:
    led.value = True
    time.sleep(0.1)
    led.value = False
    time.sleep(0.5)
```

Leave the rest of the code as-is. Save your file. See what happens to the LED on your board? Something changed! Do you know why?

You don't have to stop there! Let's keep going. Change the second `0.5` to `0.1` so it looks like this:

```
while True:
    led.value = True
    time.sleep(0.1)
    led.value = False
    time.sleep(0.1)
```

Now it blinks really fast! You decreased the both time that the code leaves the LED on and off!

Now try increasing both of the `0.1` to `1`. Your LED will blink much more slowly because you've increased the amount of time that the LED is turned on and off.

Well done! You're doing great! You're ready to start into new examples and edit them to see what happens! These were simple changes, but major changes are done using the same process. Make your desired change, save it, and get the results. That's really all there is to it!

## Naming Your Program File

CircuitPython looks for a code file on the board to run. There are four options: `code.txt`, `code.py`, `main.txt` and `main.py`. CircuitPython looks for those files, in that order, and then runs the first one it finds. While `code.py` is the recommended name for your code file, it is important to know that the other options exist. If your program doesn't seem to be updating as you work, make sure you haven't created another code file that's being read instead of the one you're working on.

---

## Connecting to the Serial Console

One of the staples of CircuitPython (and programming in general!) is something called a "print statement". This is a line you include in your code that causes your code to output text. A print statement in CircuitPython (and Python) looks like this:

```
print("Hello, world!")
```

This line in your `code.py` would result in:

```
Hello, world!
```

However, these print statements need somewhere to display. That's where the serial console comes in!

The serial console receives output from your CircuitPython board sent over USB and displays it so you can see it. This is necessary when you've included a print statement in your code and you'd like to see what you printed. It is also helpful for troubleshooting errors, because your board will send errors and the serial console will display those too.

The serial console requires an editor that has a built in terminal, or a separate terminal program. A terminal is a program that gives you a text-based interface to perform various tasks.

## Are you using Mu?

If so, good news! The serial console is built into Mu and will autodetect your board making using the serial console really really easy.

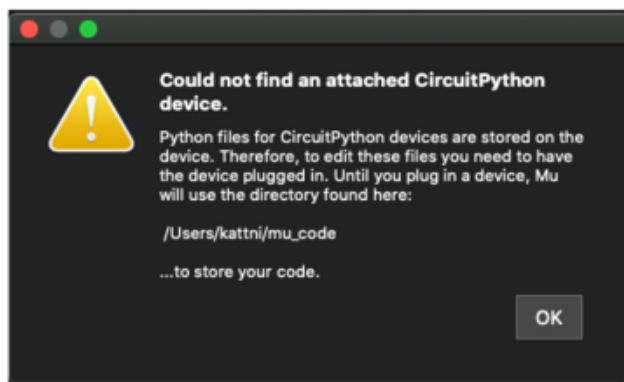

First, make sure your CircuitPython board is plugged in.

If you open Mu without a board plugged in, you may encounter the error seen here, letting you know no CircuitPython board was found and indicating where your code will be stored until you plug in a board.

If you are using Windows 7, make sure you installed the drivers ([link](#)).

Once you've opened Mu with your board plugged in, look for the Serial button in the button bar and click it.

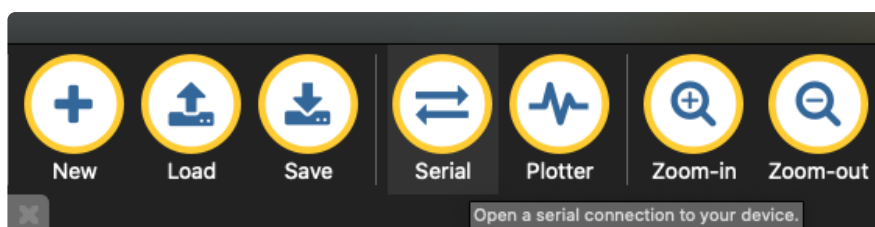

The Mu window will split in two, horizontally, and display the serial console at the bottom.

```
CircuitPython REPL
Auto-reload is on. Simply save files over USB to run them or enter REPL to disable.
code.py output:
Hello, world!

Code done running.

Press any key to enter the REPL. Use CTRL-D to reload.
```

If nothing appears in the serial console, it may mean your code is done running or has no print statements in it. Click into the serial console part of Mu, and press CTRL+D to reload.

## Serial Console Issues or Delays on Linux

If you're on Linux, and are seeing multi-second delays connecting to the serial console, or are seeing "AT" and other gibberish when you connect, then the `modemmanager` service might be interfering. Just remove it; it doesn't have much use unless you're still using dial-up modems.

To remove `modemmanager`, type the following command at a shell:

```
sudo apt purge modemmanager
```

## Setting Permissions on Linux

On Linux, if you see an error box something like the one below when you press the Serial button, you need to add yourself to a user group to have permission to connect to the serial console.



On Ubuntu and Debian, add yourself to the dialout group by doing:

```
sudo adduser $USER dialout
```

After running the command above, reboot your machine to gain access to the group. On other Linux distributions, the group you need may be different. See the [Advanced Serial Console on Linux \(\)](#) for details on how to add yourself to the right group.

## Using Something Else?

If you're not using Mu to edit, are using or if for some reason you are not a fan of its built in serial console, you can run the serial console from a separate program.

Windows requires you to download a terminal program. [Check out the Advanced Serial Console on Windows page for more details. \(\)](#)

MacOS has Terminal built in, though there are other options available for download. [Check the Advanced Serial Console on Mac page for more details. \(\)](#)

Linux has a terminal program built in, though other options are available for download. [Check the Advanced Serial Console on Linux page for more details. \(\)](#)

Once connected, you'll see something like the following.



```
Auto-reload is on. Simply save files over USB to run them or enter REPL to disable.
code.py output:
Hello, world!

Code done running.

Press any key to enter the REPL. Use CTRL-D to reload.
```

---

## Interacting with the Serial Console

Once you've successfully connected to the serial console, it's time to start using it.

The code you wrote earlier has no output to the serial console. So, you're going to edit it to create some output.

Open your code.py file into your editor, and include a `print` statement. You can print anything you like! Just include your phrase between the quotation marks inside the parentheses. For example:

```
import board
import digitalio
import time

led = digitalio.DigitalInOut(board.LED)
```

```
led.direction = digitalio.Direction.OUTPUT

while True:
    print("Hello, CircuitPython!")
    led.value = True
    time.sleep(1)
    led.value = False
    time.sleep(1)
```

Save your file.

Now, let's go take a look at the window with our connection to the serial console.

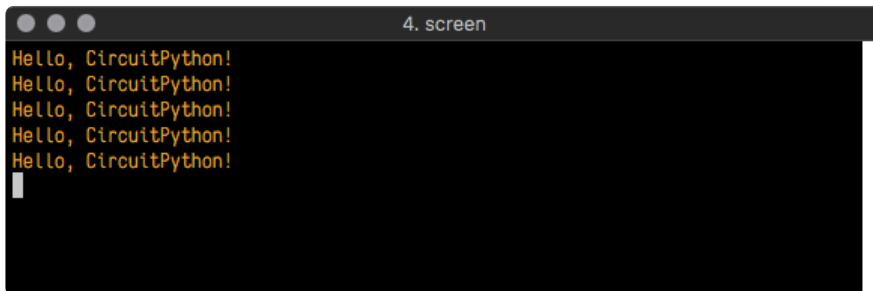

```
4. screen
Hello, CircuitPython!
Hello, CircuitPython!
Hello, CircuitPython!
Hello, CircuitPython!
Hello, CircuitPython!
```

Excellent! Our print statement is showing up in our console! Try changing the printed text to something else.

```
import board
import digitalio
import time

led = digitalio.DigitalInOut(board.LED)
led.direction = digitalio.Direction.OUTPUT

while True:
    print("Hello back to you!")
    led.value = True
    time.sleep(1)
    led.value = False
    time.sleep(1)
```

Keep your serial console window where you can see it. Save your file. You'll see what the serial console displays when the board reboots. Then you'll see your new change!

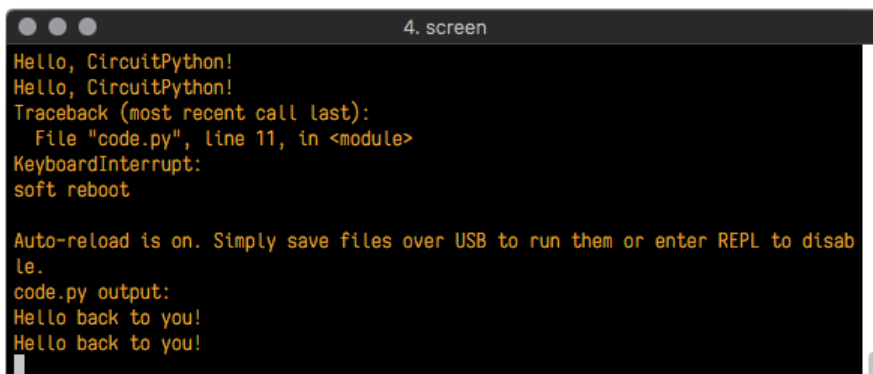

```
4. screen
Hello, CircuitPython!
Hello, CircuitPython!
Traceback (most recent call last):
  File "code.py", line 11, in <module>
KeyboardInterrupt:
soft reboot

Auto-reload is on. Simply save files over USB to run them or enter REPL to disable.
code.py output:
Hello back to you!
Hello back to you!
```

The **Traceback (most recent call last):** is telling you the last thing your board was doing before you saved your file. This is normal behavior and will happen every time the board resets. This is really handy for troubleshooting. Let's introduce an error so you can see how it is used.

Delete the **e** at the end of **True** from the line **led.value = True** so that it says **led.value = Tru**

```
import board
import digitalio
import time

led = digitalio.DigitalInOut(board.LED)
led.direction = digitalio.Direction.OUTPUT

while True:
    print("Hello back to you!")
    led.value = Tru
    time.sleep(1)
    led.value = False
    time.sleep(1)
```

Save your file. You will notice that your red LED will stop blinking, and you may have a colored status LED blinking at you. This is because the code is no longer correct and can no longer run properly. You need to fix it!

Usually when you run into errors, it's not because you introduced them on purpose. You may have 200 lines of code, and have no idea where your error could be hiding. This is where the serial console can help. Let's take a look!

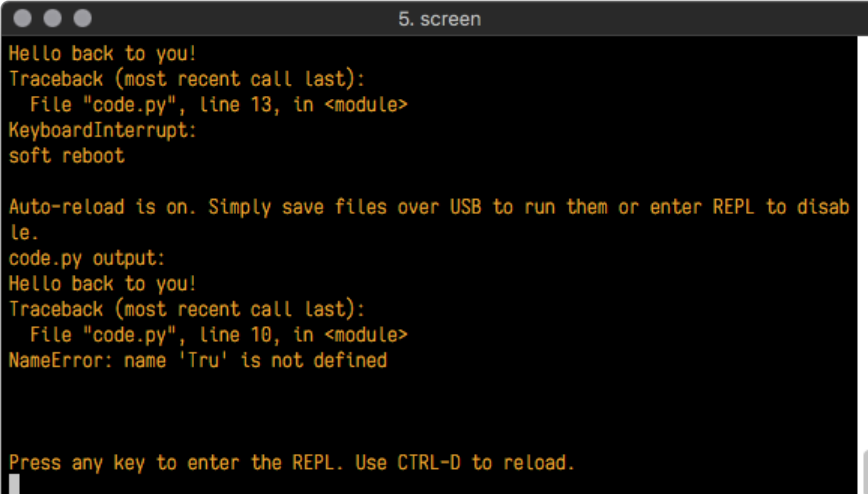

```
5. screen
Hello back to you!
Traceback (most recent call last):
  File "code.py", line 13, in <module>
KeyboardInterrupt:
soft reboot

Auto-reload is on. Simply save files over USB to run them or enter REPL to disable.
code.py output:
Hello back to you!
Traceback (most recent call last):
  File "code.py", line 10, in <module>
NameError: name 'Tru' is not defined

Press any key to enter the REPL. Use CTRL-D to reload.
```

The **Traceback (most recent call last):** is telling you that the last thing it was able to run was **line 10** in your code. The next line is your error: **NameError: name 'Tru' is not defined**. This error might not mean a lot to you, but combined with knowing the issue is on line 10, it gives you a great place to start!



Go back to your code, and take a look at line 10. Obviously, you know what the problem is already. But if you didn't, you'd want to look at line 10 and see if you could figure it out. If you're still unsure, try googling the error to get some help. In this case, you know what to look for. You spelled True wrong. Fix the typo and save your file.

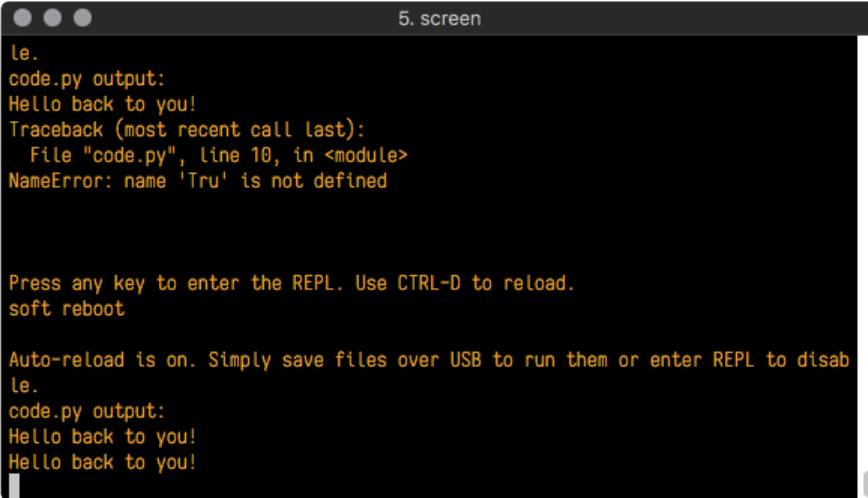

```
le.  
code.py output:  
Hello back to you!  
Traceback (most recent call last):  
  File "code.py", line 10, in <module>  
NameError: name 'Tru' is not defined  
  
Press any key to enter the REPL. Use CTRL-D to reload.  
soft reboot  
  
Auto-reload is on. Simply save files over USB to run them or enter REPL to disable.  
le.  
code.py output:  
Hello back to you!  
Hello back to you!
```

Nice job fixing the error! Your serial console is streaming and your red LED is blinking again.

The serial console will display any output generated by your code. Some sensors, such as a humidity sensor or a thermistor, receive data and you can use print statements to display that information. You can also use print statements for troubleshooting, which is called "print debugging". Essentially, if your code isn't working, and you want to know where it's failing, you can put print statements in various places to see where it stops printing.

The serial console has many uses, and is an amazing tool overall for learning and programming!

---

## The REPL

The other feature of the serial connection is the Read-Evaluate-Print-Loop, or REPL. The REPL allows you to enter individual lines of code and have them run immediately. It's really handy if you're running into trouble with a particular program and can't figure out why. It's interactive so it's great for testing new ideas.

## Entering the REPL

To use the REPL, you first need to be connected to the serial console. Once that connection has been established, you'll want to press CTRL+C.

If there is code running, in this case code measuring distance, it will stop and you'll see **Press any key to enter the REPL. Use CTRL-D to reload.** Follow those instructions, and press any key on your keyboard.

The **Traceback (most recent call last):** is telling you the last thing your board was doing before you pressed Ctrl + C and interrupted it. The **KeyboardInterrupt** is you pressing CTRL+C. This information can be handy when troubleshooting, but for now, don't worry about it. Just note that it is expected behavior.

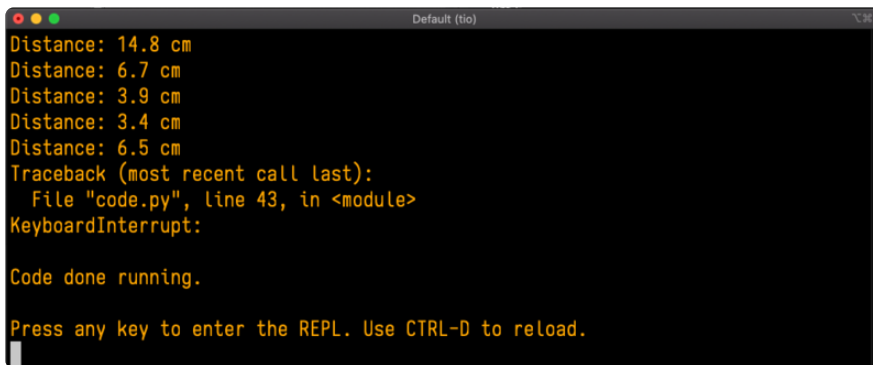

```
Distance: 14.8 cm
Distance: 6.7 cm
Distance: 3.9 cm
Distance: 3.4 cm
Distance: 6.5 cm
Traceback (most recent call last):
  File "code.py", line 43, in <module>
KeyboardInterrupt:

Code done running.

Press any key to enter the REPL. Use CTRL-D to reload.
```

If your code.py file is empty or does not contain a loop, it will show an empty output and **Code done running.** There is no information about what your board was doing before you interrupted it because there is no code running.

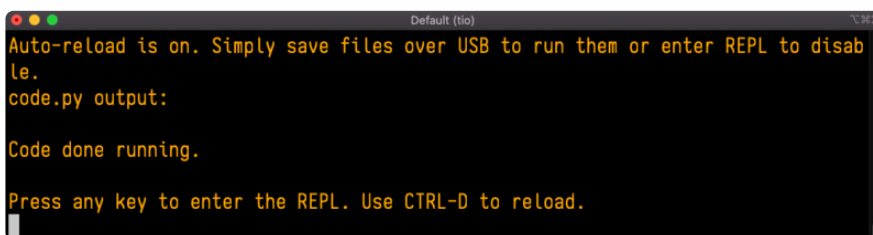

```
Auto-reload is on. Simply save files over USB to run them or enter REPL to disable.
code.py output:

Code done running.

Press any key to enter the REPL. Use CTRL-D to reload.
```

If you have no code.py on your CIRCUITPY drive, you will enter the REPL immediately after pressing CTRL+C. Again, there is no information about what your board was doing before you interrupted it because there is no code running.

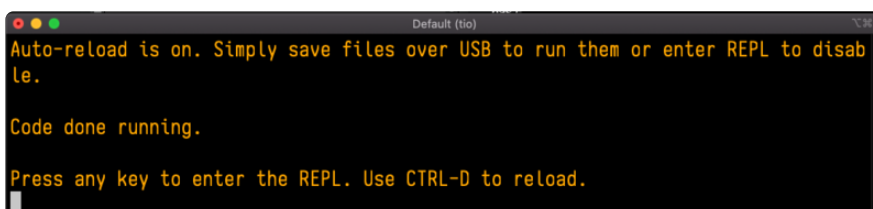

```
Auto-reload is on. Simply save files over USB to run them or enter REPL to disable.

Code done running.

Press any key to enter the REPL. Use CTRL-D to reload.
```

Regardless, once you press a key you'll see a `>>>` prompt welcoming you to the REPL!

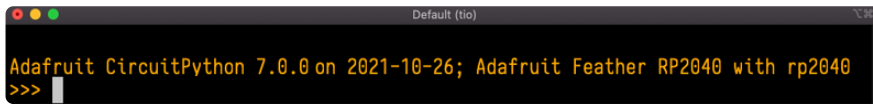

```
Default (tio)
Adafruit CircuitPython 7.0.0 on 2021-10-26; Adafruit Feather RP2040 with rp2040
>>>
```

If you have trouble getting to the `>>>` prompt, try pressing Ctrl + C a few more times.

The first thing you get from the REPL is information about your board.



```
Adafruit CircuitPython 7.0.0 on 2021-10-26; Adafruit Feather RP2040 with rp2040
```

This line tells you the version of CircuitPython you're using and when it was released. Next, it gives you the type of board you're using and the type of microcontroller the board uses. Each part of this may be different for your board depending on the versions you're working with.

This is followed by the CircuitPython prompt.



```
>>>
```

## Interacting with the REPL

From this prompt you can run all sorts of commands and code. The first thing you'll do is run `help()`. This will tell you where to start exploring the REPL. To run code in the REPL, type it in next to the REPL prompt.

Type `help()` next to the prompt in the REPL.

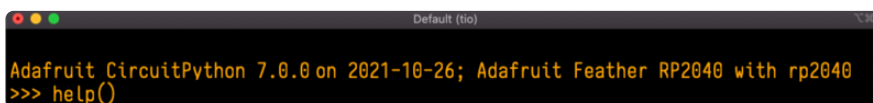

```
Default (tio)
Adafruit CircuitPython 7.0.0 on 2021-10-26; Adafruit Feather RP2040 with rp2040
>>> help()
```

Then press enter. You should then see a message.

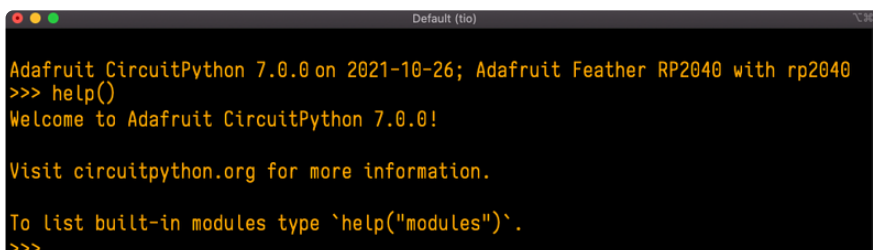

```
Default (tio)
Adafruit CircuitPython 7.0.0 on 2021-10-26; Adafruit Feather RP2040 with rp2040
>>> help()
Welcome to Adafruit CircuitPython 7.0.0!

Visit circuitpython.org for more information.

To list built-in modules type `help("modules")`.
>>>
```

First part of the message is another reference to the version of CircuitPython you're using. Second, a URL for the CircuitPython related project guides. Then... wait. What's this? **To list built-in modules type `help("modules")`**. Remember the modules you learned about while going through creating code? That's exactly what this is talking about! This is a perfect place to start. Let's take a look!

Type **`help("modules")`** into the REPL next to the prompt, and press enter.

```
>>> help("modules")
__main__      board                micropython         storage
_bleio        builtins            msgpack             struct
adafruit_bus_device busio                neopixel_write     supervisor
adafruit_pixelbuf collections        onewireio           synthio
aesio         countio             os                  sys
alarm         digitalio           paralleldisplay     terminalio
analogio      displayio           pulseio             time
array         errno               pwmio               touchio
atexit        fontio              qrio                traceback
audiobusio   framebufferio      rainbowio           ulab
audiocore     gc                  random              usb_cdc
audiomixer   getpass            re                  usb_hid
audiomp3     imagecapture       rgbmatrix           usb_midi
audiopwmio   io                  rotaryio            vectorio
binascii     json                rp2pio              watchdog
bitbangio    keypad              rtc
bitmaptools  math                sdcardio
bitops       microcontroller    sharpdisplay
Plus any modules on the filesystem
>>>
```

This is a list of all the core modules built into CircuitPython, including **`board`**. Remember, **`board`** contains all of the pins on the board that you can use in your code. From the REPL, you are able to see that list!

Type **`import board`** into the REPL and press enter. It'll go to a new prompt. It might look like nothing happened, but that's not the case! If you recall, the **`import`** statement simply tells the code to expect to do something with that module. In this case, it's telling the REPL that you plan to do something with that module.

```
>>> import board
>>>
```

Next, type **`dir(board)`** into the REPL and press enter.

```
>>> dir(board)
['_class__', '_name__', 'A0', 'A1', 'A2', 'A3', 'D0', 'D1', 'D10', 'D11', 'D12', 'D13',
'D24', 'D25', 'D4', 'D5', 'D6', 'D9', 'I2C', 'LED', 'MISO', 'MOSI', 'NEOPIXEL', 'RX', 'SCK',
', 'SCL', 'SDA', 'SPI', 'TX', 'UART', 'board_id']
>>>
```

This is a list of all of the pins on your board that are available for you to use in your code. Each board's list will differ slightly depending on the number of pins available. Do you see **`LED`**? That's the pin you used to blink the red LED!

The REPL can also be used to run code. Be aware that any code you enter into the REPL isn't saved anywhere. If you're testing something new that you'd like to keep, make sure you have it saved somewhere on your computer as well!

Every programmer in every programming language starts with a piece of code that says, "Hello, World." You're going to say hello to something else. Type into the REPL:

```
print("Hello, CircuitPython!")
```

Then press enter.

```
>>> print("Hello, CircuitPython")
Hello, CircuitPython
>>> |
```

That's all there is to running code in the REPL! Nice job!

You can write single lines of code that run stand-alone. You can also write entire programs into the REPL to test them. Remember that nothing typed into the REPL is saved.

There's a lot the REPL can do for you. It's great for testing new ideas if you want to see if a few new lines of code will work. It's fantastic for troubleshooting code by entering it one line at a time and finding out where it fails. It lets you see what modules are available and explore those modules.

Try typing more into the REPL to see what happens!

Everything typed into the REPL is ephemeral. Once you reload the REPL or return to the serial console, nothing you typed will be retained in any memory space. So be sure to save any desired code you wrote somewhere else, or you'll lose it when you leave the current REPL instance!

## Returning to the Serial Console

When you're ready to leave the REPL and return to the serial console, simply press CT RL+D. This will reload your board and reenter the serial console. You will restart the program you had running before entering the REPL. In the console window, you'll see any output from the program you had running. And if your program was affecting anything visual on the board, you'll see that start up again as well.

You can return to the REPL at any time!

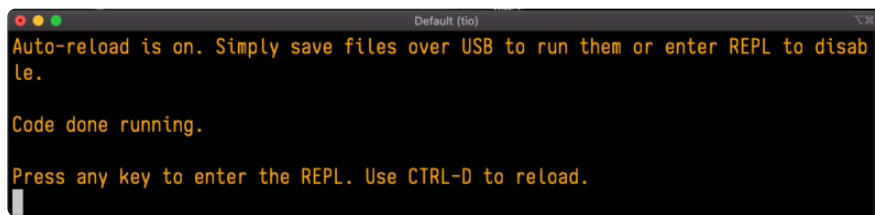

```
Default (tio)
Auto-reload is on. Simply save files over USB to run them or enter REPL to disable.
Code done running.
Press any key to enter the REPL. Use CTRL-D to reload.
```

## CircuitPython Libraries

As CircuitPython development continues and there are new releases, Adafruit will stop supporting older releases. Visit <https://circuitpython.org/downloads> to download the latest version of CircuitPython for your board. You must download the CircuitPython Library Bundle that matches your version of CircuitPython. Please update CircuitPython and then visit <https://circuitpython.org/libraries> to download the latest Library Bundle.

Each CircuitPython program you run needs to have a lot of information to work. The reason CircuitPython is so simple to use is that most of that information is stored in other files and works in the background. These files are called libraries. Some of them are built into CircuitPython. Others are stored on your CIRCUITPY drive in a folder called lib. Part of what makes CircuitPython so great is its ability to store code separately from the firmware itself. Storing code separately from the firmware makes it easier to update both the code you write and the libraries you depend.

Your board may ship with a lib folder already, it's in the base directory of the drive. If not, simply create the folder yourself. When you first install CircuitPython, an empty lib directory will be created for you.

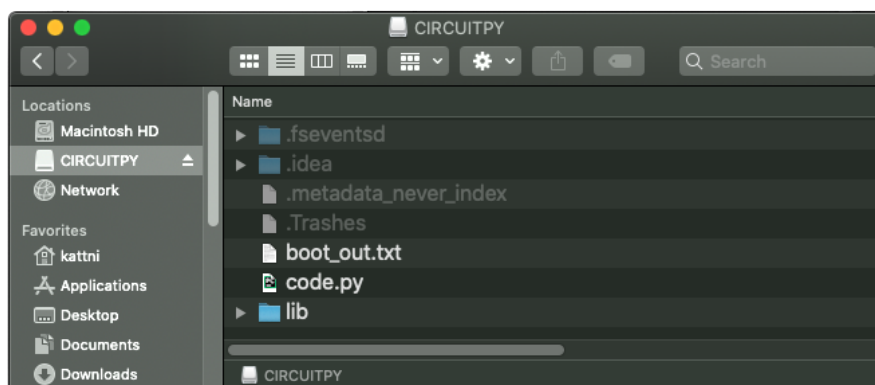

CircuitPython libraries work in the same way as regular Python modules so the [Python docs \(\)](#) are an excellent reference for how it all should work. In Python terms, you can

place our library files in the lib directory because it's part of the Python path by default.

One downside of this approach of separate libraries is that they are not built in. To use them, one needs to copy them to the CIRCUITPY drive before they can be used. Fortunately, there is a library bundle.

The bundle and the library releases on GitHub also feature optimized versions of the libraries with the .mpy file extension. These files take less space on the drive and have a smaller memory footprint as they are loaded.

Due to the regular updates and space constraints, Adafruit does not ship boards with the entire bundle. Therefore, you will need to load the libraries you need when you begin working with your board. You can find example code in the guides for your board that depends on external libraries.

Either way, as you start to explore CircuitPython, you'll want to know how to get libraries on board.

## The Adafruit Learn Guide Project Bundle

The quickest and easiest way to get going with a project from the Adafruit Learn System is by utilising the Project Bundle. Most guides now have a Download Project Bundle button available at the top of the full code example embed. This button downloads all the necessary files, including images, etc., to get the guide project up and running. Simply click, open the resulting zip, copy over the right files, and you're good to go!

The first step is to find the Download Project Bundle button in the guide you're working on.

The Download Project Bundle button is only available on full demo code embedded from GitHub in a Learn guide. Code snippets will NOT have the button available.

🏠 > Circuit Playground Express: Piano in the Key of Lime > Piano in the Key of Lime



## Piano in the Key of Lime

Now we'll take everything we learned and put it together!

Be sure to save your current code.py if you've changed anything you'd like to keep. Download the following file. Rename it to code.py and save it to your Circuit Playground Express.

[Download Project Bundle](#) [Copy Code](#)

```
# SPDX-FileCopyrightText: 2017 Kattni Rembor for Adafruit Industries
#
# SPDX-License-Identifier: MIT

from adafruit_circuitplayground import cp

while True:
    if cp.switch:
        print("Slide switch off!")
        cp.pixels.fill((0, 0, 0))
```

**Circuit Playground Express: Piano in the Key of Lime**  
By [Kattni Rembor](#)  
Create a full scale tone piano using CircuitPython, capacitive touch and some cute little fruits.

When you copy the contents of the Project Bundle to your CIRCUITPY drive, it will replace all the existing content! If you don't want to lose anything, ensure you copy your current code to your computer before you copy over the new Project Bundle content!

The Download Project Bundle button downloads a zip file. This zip contains a series of directories, nested within which is the code.py, any applicable assets like images or audio, and the lib/ folder containing all the necessary libraries. The following zip was downloaded from the Piano in the Key of Lime guide.

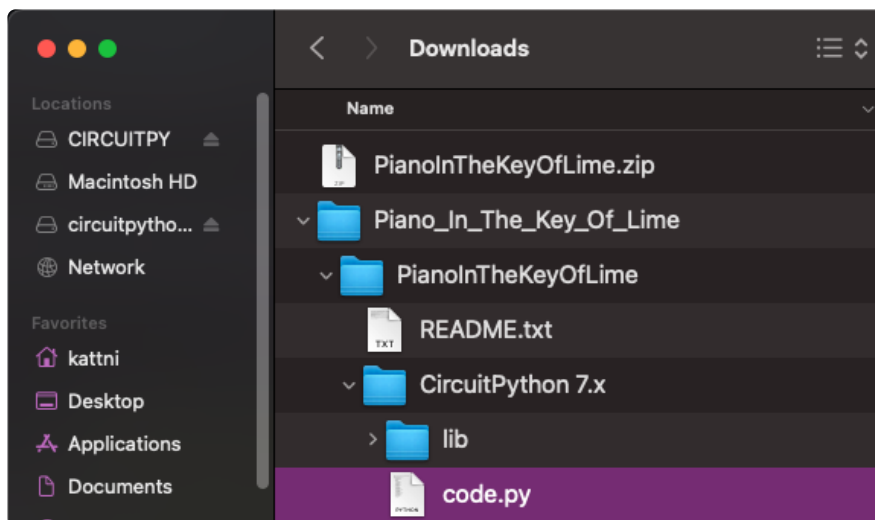

The Piano in the Key of Lime guide was chosen as an example. That guide is specific to Circuit Playground Express, and cannot be used on all boards. Do not expect to download that exact bundle and have it work on your non-CPX microcontroller.

When you open the zip, you'll find some nested directories. Navigate through them until you find what you need. You'll eventually find a directory for your CircuitPython



version (in this case, 7.x). In the version directory, you'll find the file and directory you need: `code.py` and `lib/`. Once you find the content you need, you can copy it all over to your CIRCUITPY drive, replacing any files already on the drive with the files from the freshly downloaded zip.

In some cases, there will be other files such as audio or images in the same directory as `code.py` and `lib/`. Make sure you include all the files when you copy things over!

Once you copy over all the relevant files, the project should begin running! If you find that the project is not running as expected, make sure you've copied ALL of the project files onto your microcontroller board.

That's all there is to using the Project Bundle!

## The Adafruit CircuitPython Library Bundle

Adafruit provides CircuitPython libraries for much of the hardware they provide, including sensors, breakouts and more. To eliminate the need for searching for each library individually, the libraries are available together in the Adafruit CircuitPython Library Bundle. The bundle contains all the files needed to use each library.

### Downloading the Adafruit CircuitPython Library Bundle

You can download the latest Adafruit CircuitPython Library Bundle release by clicking the button below. The libraries are being constantly updated and improved, so you'll always want to download the latest bundle.

Match up the bundle version with the version of CircuitPython you are running. For example, you would download the 6.x library bundle if you're running any version of CircuitPython 6, or the 7.x library bundle if you're running any version of CircuitPython 7, etc. If you mix libraries with major CircuitPython versions, you will get incompatible mpy errors due to changes in library interfaces possible during major version changes.

Click to visit [circuitpython.org](https://circuitpython.org) for the latest Adafruit CircuitPython Library Bundle

Download the bundle version that matches your CircuitPython firmware version. If you don't know the version, check the version info in `boot_out.txt` file on the CIRCUITPY drive, or the initial prompt in the CircuitPython REPL. For example, if you're running v7.0.0, download the 7.x library bundle.

There's also a py bundle which contains the uncompressed python files, you probably don't want that unless you are doing advanced work on libraries.

## The CircuitPython Community Library Bundle

The CircuitPython Community Library Bundle is made up of libraries written and provided by members of the CircuitPython community. These libraries are often written when community members encountered hardware not supported in the Adafruit Bundle, or to support a personal project. The authors all chose to submit these libraries to the Community Bundle make them available to the community.

These libraries are maintained by their authors and are not supported by Adafruit. As you would with any library, if you run into problems, feel free to file an issue on the GitHub repo for the library. Bear in mind, though, that most of these libraries are supported by a single person and you should be patient about receiving a response. Remember, these folks are not paid by Adafruit, and are volunteering their personal time when possible to provide support.

## Downloading the CircuitPython Community Library Bundle

You can download the latest CircuitPython Community Library Bundle release by clicking the button below. The libraries are being constantly updated and improved, so you'll always want to download the latest bundle.

[Click for the latest CircuitPython Community Library Bundle release](#)

The link takes you to the latest release of the CircuitPython Community Library Bundle on GitHub. There are multiple versions of the bundle available. Download the bundle version that matches your CircuitPython firmware version. If you don't know the version, check the version info in `boot_out.txt` file on the CIRCUITPY drive, or the initial prompt in the CircuitPython REPL. For example, if you're running v7.0.0, download the 7.x library bundle.

# Understanding the Bundle

After downloading the zip, extract its contents. This is usually done by double clicking on the zip. On Mac OSX, it places the file in the same directory as the zip.

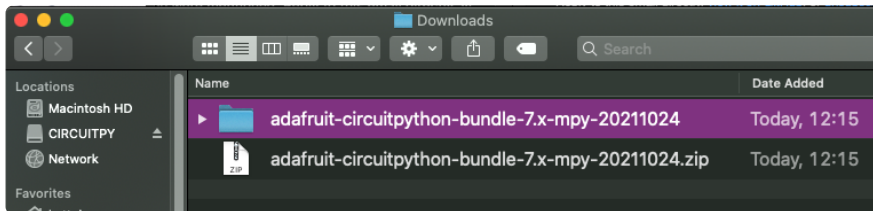

Open the bundle folder. Inside you'll find two information files, and two folders. One folder is the lib bundle, and the other folder is the examples bundle.

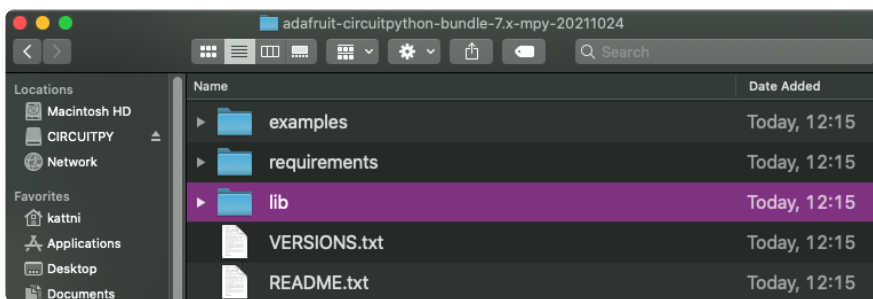

Now open the lib folder. When you open the folder, you'll see a large number of .mpy files, and folders.

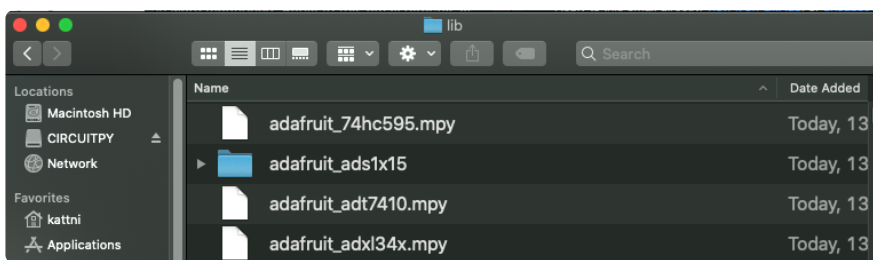

## Example Files

All example files from each library are now included in the bundles in an examples directory (as seen above), as well as an examples-only bundle. These are included for two main reasons:

- Allow for quick testing of devices.
- Provide an example base of code, that is easily built upon for individualized purposes.

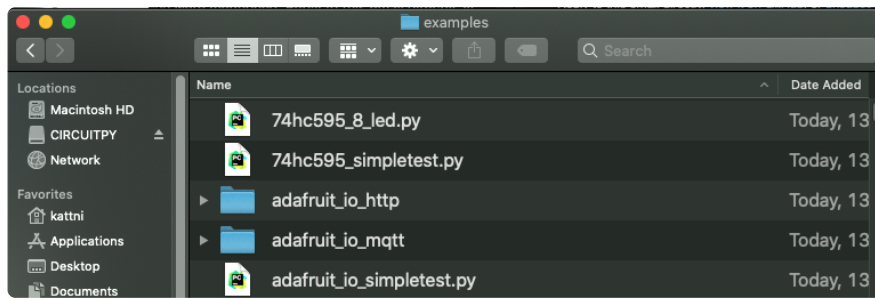

## Copying Libraries to Your Board

First open the lib folder on your CIRCUITPY drive. Then, open the lib folder you extracted from the downloaded zip. Inside you'll find a number of folders and .mpy files. Find the library you'd like to use, and copy it to the lib folder on CIRCUITPY.

If the library is a directory with multiple .mpy files in it, be sure to copy the entire folder to CIRCUITPY/lib.

This also applies to example files. Open the examples folder you extracted from the downloaded zip, and copy the applicable file to your CIRCUITPY drive. Then, rename it to code.py to run it.

If a library has multiple .mpy files contained in a folder, be sure to copy the entire folder to CIRCUITPY/lib.

## Understanding Which Libraries to Install

You now know how to load libraries on to your CircuitPython-compatible microcontroller board. You may now be wondering, how do you know which libraries you need to install? Unfortunately, it's not always straightforward. Fortunately, there is an obvious place to start, and a relatively simple way to figure out the rest. First up: the best place to start.

When you look at most CircuitPython examples, you'll see they begin with one or more `import` statements. These typically look like the following:

- `import library_or_module`

However, `import` statements can also sometimes look like the following:

- `from library_or_module import name`
- `from library_or_module.subpackage import name`
- `from library_or_module import name as local_name`

They can also have more complicated formats, such as including a `try` / `except` block, etc.

The important thing to know is that an `import` statement will always include the name of the module or library that you're importing.

Therefore, the best place to start is by reading through the `import` statements.

Here is an example import list for you to work with in this section. There is no setup or other code shown here, as the purpose of this section involves only the import list.

```
import time
import board
import neopixel
import adafruit_lis3dh
import usb_hid
from adafruit_hid.consumer_control import ConsumerControl
from adafruit_hid.consumer_control_code import ConsumerControlCode
```

Keep in mind, not all imported items are libraries. Some of them are almost always built-in CircuitPython modules. How do you know the difference? Time to visit the REPL.

In the [Interacting with the REPL section \(\)](#) on [The REPL page \(\)](#) in this guide, the `help("modules")` command is discussed. This command provides a list of all of the built-in modules available in CircuitPython for your board. So, if you connect to the serial console on your board, and enter the REPL, you can run `help("modules")` to see what modules are available for your board. Then, as you read through the `import` statements, you can, for the purposes of figuring out which libraries to load, ignore the statement that import modules.

The following is the list of modules built into CircuitPython for the Feather RP2040. Your list may look similar or be anything down to a significant subset of this list for smaller boards.

```
>>> help("modules")
__main__      board          micropython   storage
_bleio        builtins       msgpack       struct
adafruit_bus_device  collections   busio         neopixel_write  supervisor
adafruit_pixelbuf  countio       onewireio    synthio
aesio          digitalio     os            sys
alarm          displayio    paralledisplay  terminalio
analogio       errno        pulseio      time
array          fontio       pwmio        touchio
atexit         framebufferio  qrio         traceback
audiobusio     gc           rainbowio    ulab
audiocore      getpass      random       usb_cdc
audiomixer     imagecapture  re           usb_hid
audiomp3       io           rgbmatrix    usb_midi
audiopwmio     json         rotaryio     vectorio
binascii       keypad       rp2pio       watchdog
bitbangio      math         rtc
bitmaptools    microcontroller  sdcardio
bitops         sharpdisplay
```

Now that you know what you're looking for, it's time to read through the import statements. The first two, `time` and `board`, are on the modules list above, so they're built-in.

The next one, `neopixel`, is not on the module list. That means it's your first library! So, you would head over to the bundle zip you downloaded, and search for neopixel. There is a `neopixel.mpy` file in the bundle zip. Copy it over to the lib folder on your CIRCUIPY drive. The following one, `adafruit_lis3dh`, is also not on the module list. Follow the same process for `adafruit_lis3dh`, where you'll find `adafruit_lis3dh.mpy`, and copy that over.

The fifth one is `usb_hid`, and it is in the modules list, so it is built in. Often all of the built-in modules come first in the import list, but sometimes they don't! Don't assume that everything after the first library is also a library, and verify each import with the modules list to be sure. Otherwise, you'll search the bundle and come up empty!

The final two imports are not as clear. Remember, when `import` statements are formatted like this, the first thing after the `from` is the library name. In this case, the library name is `adafruit_hid`. A search of the bundle will find an `adafruit_hid` folder. When a library is a folder, you must copy the entire folder and its contents as it is in the bundle to the lib folder on your CIRCUIPY drive. In this case, you would copy the entire `adafruit_hid` folder to your CIRCUIPY/lib folder.

Notice that there are two imports that begin with `adafruit_hid`. Sometimes you will need to import more than one thing from the same library. Regardless of how many times you import the same library, you only need to load the library by copying over the `adafruit_hid` folder once.

That is how you can use your example code to figure out what libraries to load on your CircuitPython-compatible board!

There are cases, however, where libraries require other libraries internally. The internally required library is called a dependency. In the event of library dependencies, the easiest way to figure out what other libraries are required is to connect to the serial console and follow along with the `ImportError` printed there. The following is a very simple example of an `ImportError`, but the concept is the same for any missing library.

## Example: `ImportError` Due to Missing Library

If you choose to load libraries as you need them, or you're starting fresh with an existing example, you may end up with code that tries to use a library you haven't yet loaded. This section will demonstrate what happens when you try to utilise a library that you don't have loaded on your board, and cover the steps required to resolve the issue.

This demonstration will only return an error if you do not have the required library loaded into the lib folder on your CIRCUITPY drive.

Let's use a modified version of the Blink example.

```
import board
import time
import simpleio

led = simpleio.DigitalOut(board.LED)

while True:
    led.value = True
    time.sleep(0.5)
    led.value = False
    time.sleep(0.5)
```

Save this file. Nothing happens to your board. Let's check the serial console to see what's going on.

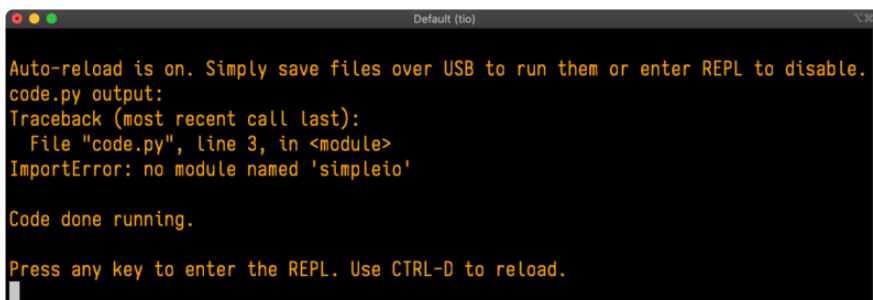
A screenshot of a serial console window titled "Default (tio)". The window has a black background with yellow text. The text shows the following output: "Auto-reload is on. Simply save files over USB to run them or enter REPL to disable.", "code.py output:", "Traceback (most recent call last):", "File \"code.py\", line 3, in <module>", "ImportError: no module named 'simpleio'", "Code done running.", and "Press any key to enter the REPL. Use CTRL-D to reload." data-bbox="220 752 770 885"/>

```
Auto-reload is on. Simply save files over USB to run them or enter REPL to disable.
code.py output:
Traceback (most recent call last):
  File "code.py", line 3, in <module>
ImportError: no module named 'simpleio'

Code done running.

Press any key to enter the REPL. Use CTRL-D to reload.
```

You have an `ImportError`. It says there is `no module named 'simpleio'`. That's the one you just included in your code!

Click the link above to download the correct bundle. Extract the lib folder from the downloaded bundle file. Scroll down to find `simpleio.mpy`. This is the library file you're looking for! Follow the steps above to load an individual library file.

The LED starts blinking again! Let's check the serial console.

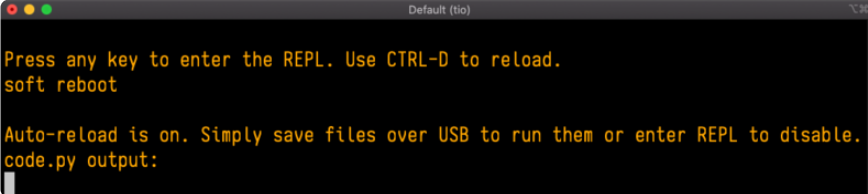

```
Default (tio)
Press any key to enter the REPL. Use CTRL-D to reload.
soft reboot

Auto-reload is on. Simply save files over USB to run them or enter REPL to disable.
code.py output:
```

No errors! Excellent. You've successfully resolved an `ImportError`!

If you run into this error in the future, follow along with the steps above and choose the library that matches the one you're missing.

## Library Install on Non-Express Boards

If you have an M0 non-Express board such as Trinket M0, Gemma M0, QT Py M0, or one of the M0 Trinkeys, you'll want to follow the same steps in the example above to install libraries as you need them. Remember, you don't need to wait for an `ImportError` if you know what library you added to your code. Open the library bundle you downloaded, find the library you need, and drag it to the lib folder on your CIRCUITPY drive.

You can still end up running out of space on your M0 non-Express board even if you only load libraries as you need them. There are a number of steps you can use to try to resolve this issue. You'll find suggestions on the [Troubleshooting page](#) ().

## Updating CircuitPython Libraries and Examples

Libraries and examples are updated from time to time, and it's important to update the files you have on your CIRCUITPY drive.



To update a single library or example, follow the same steps above. When you drag the library file to your lib folder, it will ask if you want to replace it. Say yes. That's it!

A new library bundle is released every time there's an update to a library. Updates include things like bug fixes and new features. It's important to check in every so often to see if the libraries you're using have been updated.

## CircUp CLI Tool

There is a command line interface (CLI) utility called [CircUp \(\)](#) that can be used to easily install and update libraries on your device. Follow the directions on the [install page within the CircUp learn guide \(\)](#). Once you've got it installed you run the command `circup update` in a terminal to interactively update all libraries on the connected CircuitPython device. See the [usage page in the CircUp guide \(\)](#) for a full list of functionality

---

# Advanced Serial Console on Windows

## Windows 7 and 8.1

If you're using Windows 7 (or 8 or 8.1), you'll need to install drivers. See the [Windows 7 and 8.1 Drivers page \(\)](#) for details. You will not need to install drivers on Mac, Linux or Windows 10.

You are strongly encouraged to upgrade to Windows 10 if you are still using Windows 7 or Windows 8 or 8.1. Windows 7 has reached end-of-life and no longer receives security updates. A free upgrade to Windows 10 is [still available \(\)](#).

## What's the COM?

First, you'll want to find out which serial port your board is using. When you plug your board in to USB on your computer, it connects to a serial port. The port is like a door through which your board can communicate with your computer using USB.

You'll use Windows Device Manager to determine which port the board is using. The easiest way to determine which port the board is using is to first check without the board plugged in. Open Device Manager. Click on Ports (COM & LPT). You should find something already in that list with (COM#) after it where # is a number.

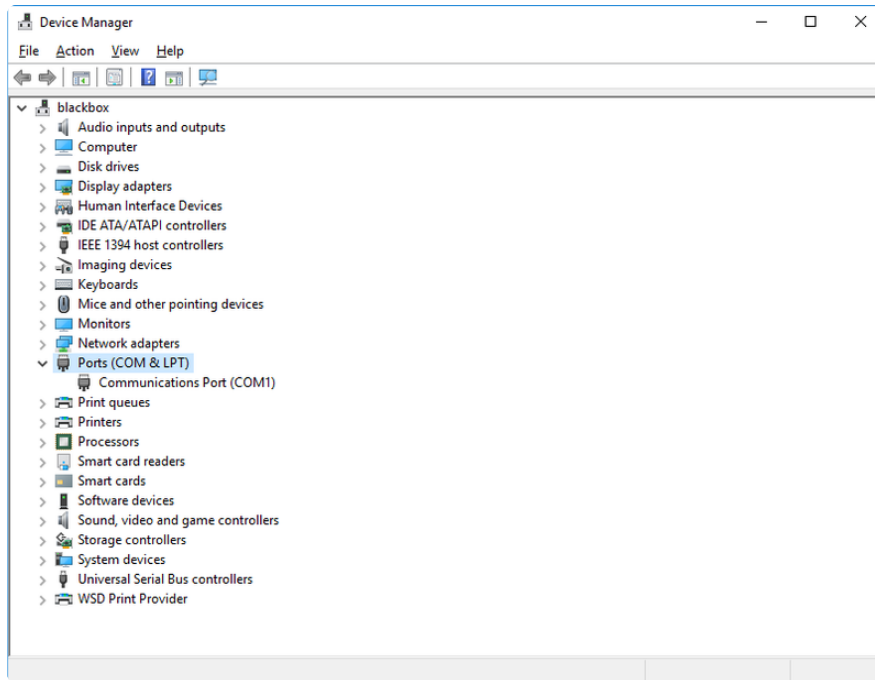

Now plug in your board. The Device Manager list will refresh and a new item will appear under Ports (COM & LPT). You'll find a different (COM#) after this item in the list.

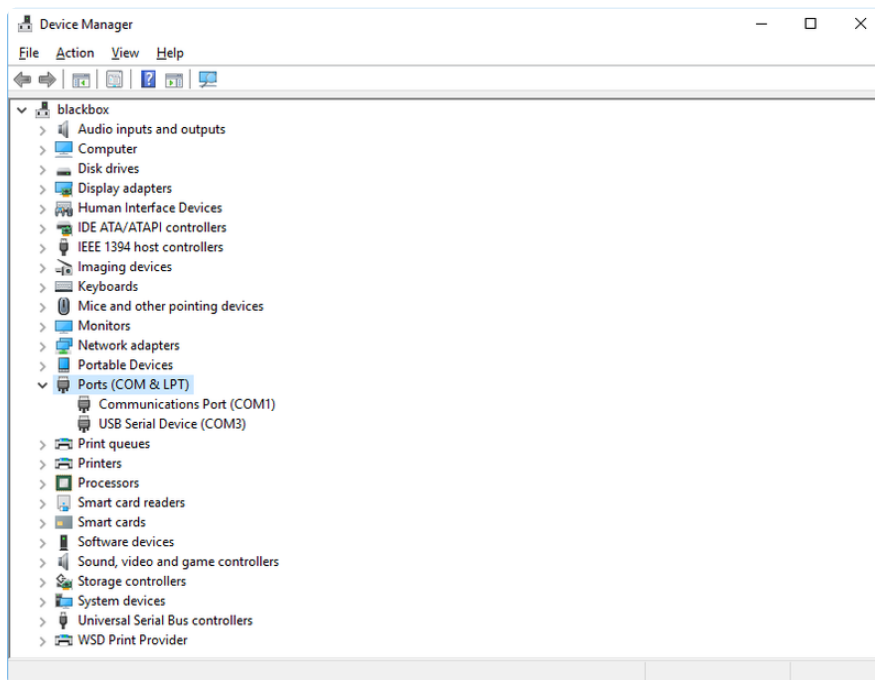

Sometimes the item will refer to the name of the board. Other times it may be called something like USB Serial Device, as seen in the image above. Either way, there is a new (COM#) following the name. This is the port your board is using.

# Install Putty

If you're using Windows, you'll need to download a terminal program. You're going to use PuTTY.

The first thing to do is download the [latest version of PuTTY \(\)](#). You'll want to download the Windows installer file. It is most likely that you'll need the 64-bit version. Download the file and install the program on your machine. If you run into issues, you can try downloading the 32-bit version instead. However, the 64-bit version will work on most PCs.

Now you need to open PuTTY.

- Under Connection type: choose the button next to Serial.
- In the box under Serial line, enter the serial port you found that your board is using.
- In the box under Speed, enter 115200. This called the baud rate, which is the speed in bits per second that data is sent over the serial connection. For boards with built in USB it doesn't matter so much but for ESP8266 and other board with a separate chip, the speed required by the board is 115200 bits per second. So you might as well just use 115200!

If you want to save those settings for later, use the options under Load, save or delete a stored session. Enter a name in the box under Saved Sessions, and click the Save button on the right.

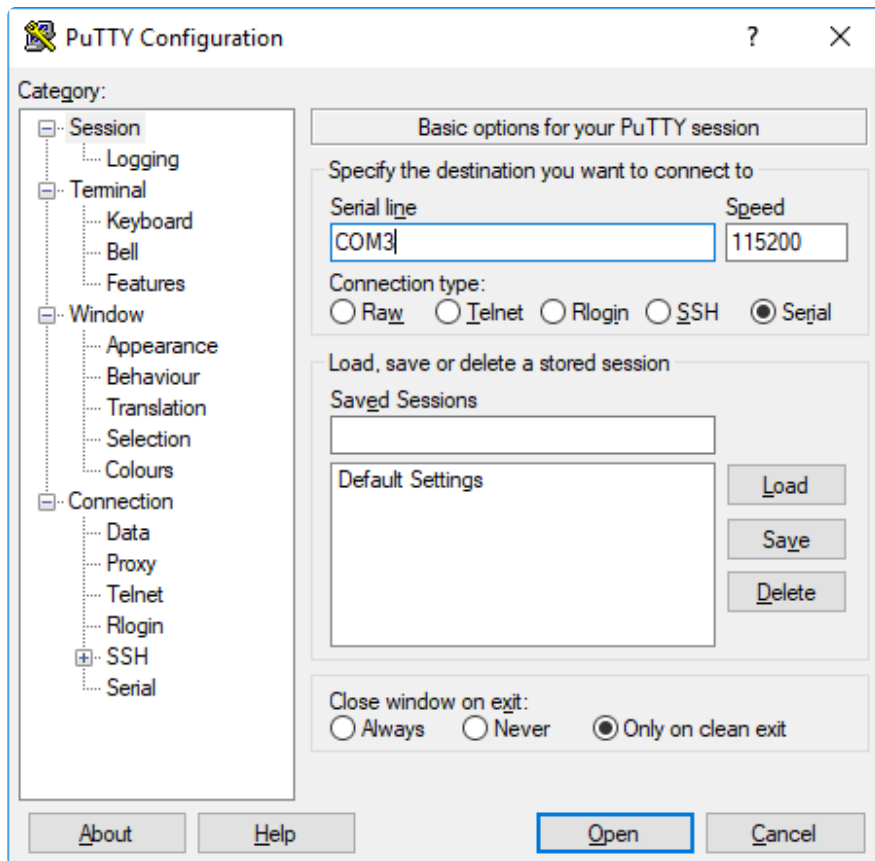

Once your settings are entered, you're ready to connect to the serial console. Click "Open" at the bottom of the window. A new window will open.

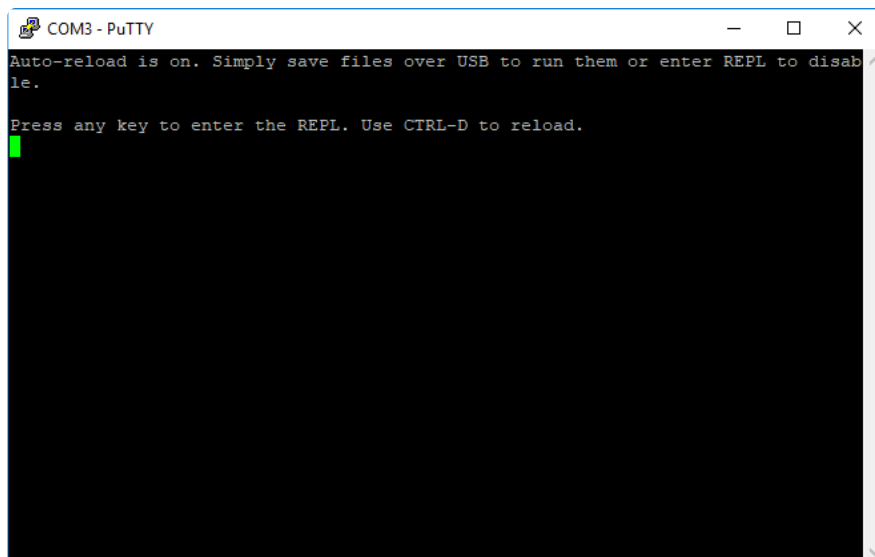

If no code is running, the window will either be blank or will look like the window above. Now you're ready to see the results of your code.

Great job! You've connected to the serial console!

---

# Advanced Serial Console on Mac

Connecting to the serial console on Mac does not require installing any drivers or extra software. You'll use a terminal program to find your board, and `screen` to connect to it. Terminal and `screen` both come installed by default.

## What's the Port?

First you'll want to find out which serial port your board is using. When you plug your board in to USB on your computer, it connects to a serial port. The port is like a door through which your board can communicate with your computer using USB.

The easiest way to determine which port the board is using is to first check without the board plugged in. Open Terminal and type the following:

```
ls /dev/tty.*
```

Each serial connection shows up in the `/dev/` directory. It has a name that starts with `tty.`. The command `ls` shows you a list of items in a directory. You can use `*` as a wildcard, to search for files that start with the same letters but end in something different. In this case, you're asking to see all of the listings in `/dev/` that start with `tty.` and end in anything. This will show us the current serial connections.

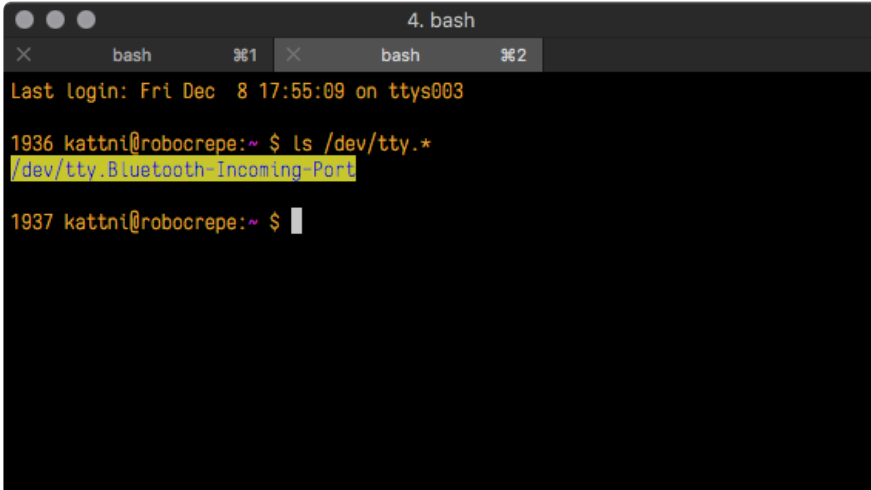

```
4. bash
bash  %1  bash  %2
Last login: Fri Dec  8 17:55:09 on ttys003
1936 kattni@robocrepe:~ $ ls /dev/tty.*
/dev/tty.Blueetooth-Incoming-Port
1937 kattni@robocrepe:~ $
```

Now, plug your board. In Terminal, type:

```
ls /dev/tty.*
```

This will show you the current serial connections, which will now include your board.

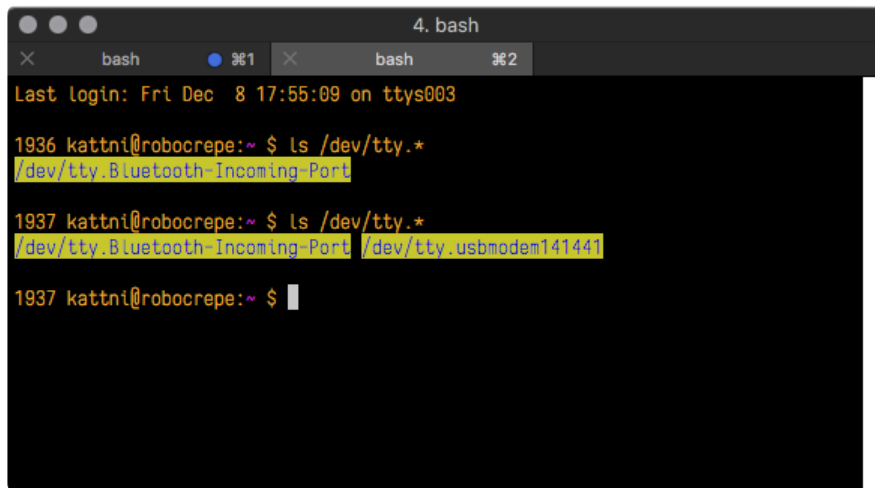

```
4. bash
bash  #1 bash  #2
Last login: Fri Dec 8 17:55:09 on ttys003
1936 kattni@robocrepe:~ $ ls /dev/tty.*
/dev/tty.Bluetooth-Incoming-Port
1937 kattni@robocrepe:~ $ ls /dev/tty.*
/dev/tty.Bluetooth-Incoming-Port /dev/tty.usbmodem141441
1937 kattni@robocrepe:~ $
```

A new listing has appeared called `/dev/tty.usbmodem141441`. The `tty.usbmodem141441` part of this listing is the name the example board is using. Yours will be called something similar.

Using Linux, a new listing has appeared called `/dev/ttyACM0`. The `ttyACM0` part of this listing is the name the example board is using. Yours will be called something similar.

## Connect with screen

Now that you know the name your board is using, you're ready connect to the serial console. You're going to use a command called `screen`. The `screen` command is included with MacOS. To connect to the serial console, use Terminal. Type the following command, replacing `board_name` with the name you found your board is using:

```
screen /dev/tty.board_name 115200
```

The first part of this establishes using the `screen` command. The second part tells screen the name of the board you're trying to use. The third part tells screen what baud rate to use for the serial connection. The baud rate is the speed in bits per second that data is sent over the serial connection. In this case, the speed required by the board is 115200 bits per second.

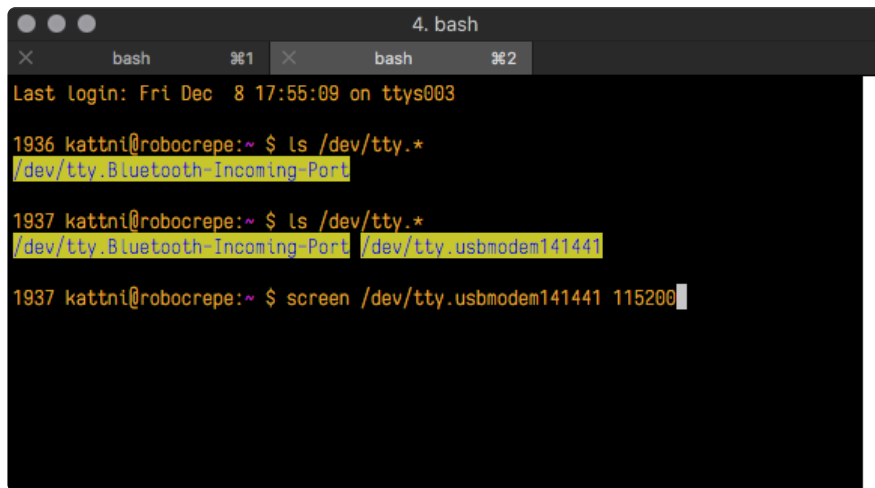

```
4. bash
bash %1 bash %2
Last login: Fri Dec 8 17:55:09 on ttys003
1936 kattni@robocrepe:~ $ ls /dev/tty.*
/dev/tty.Bluetooth-Incoming-Port
1937 kattni@robocrepe:~ $ ls /dev/tty.*
/dev/tty.Bluetooth-Incoming-Port /dev/tty.usbmodem141441
1937 kattni@robocrepe:~ $ screen /dev/tty.usbmodem141441 115200
```

Press enter to run the command. It will open in the same window. If no code is running, the window will be blank. Otherwise, you'll see the output of your code.

Great job! You've connected to the serial console!

---

## Frequently Asked Questions

These are some of the common questions regarding CircuitPython and CircuitPython microcontrollers.

---

### What are some common acronyms to know?

- CP or CPy = [CircuitPython \(\)](#)
  - CPC = [Circuit Playground Classic \(\)](#) (does not run CircuitPython)
  - CPX = [Circuit Playground Express \(\)](#)
  - CPB = [Circuit Playground Bluefruit \(\)](#)
- 

### Using Older Versions

As CircuitPython development continues and there are new releases, Adafruit will stop supporting older releases. Visit <https://circuitpython.org/downloads> to download the latest version of CircuitPython for your board. You must download the CircuitPython Library Bundle that matches your version of CircuitPython. Please update CircuitPython and then visit <https://circuitpython.org/libraries> to download the latest Library Bundle.

---

## I have to continue using CircuitPython 6.x or earlier. Where can I find compatible libraries?

We are no longer building or supporting the CircuitPython 6.x or earlier library bundles. We highly encourage you to [update CircuitPython to the latest version \(\)](#) and use [the current version of the libraries \(\)](#). However, if for some reason you cannot update, here are the last available library bundles for older versions:

- [2.x bundle \(\)](#)
  - [3.x bundle \(\)](#)
  - [4.x bundle \(\)](#)
  - [5.x bundle \(\)](#)
  - [6.x bundle \(\)](#)
- 

## Python Arithmetic

---

### Does CircuitPython support floating-point numbers?

All CircuitPython boards support floating point arithmetic, even if the microcontroller chip does not support floating point in hardware. Floating point numbers are stored in 30 bits, with an 8-bit exponent and a 22-bit mantissa. Note that this is two bits less than standard 32-bit single-precision floats. You will get about 5-1/2 digits of decimal precision.

(The broadcom port may provide 64-bit floats in some cases.)

---

### Does CircuitPython support long integers, like regular Python?

Python long integers (integers of arbitrary size) are available on most builds, except those on boards with the smallest available firmware size. On these boards, integers are stored in 31 bits.

Boards without long integer support are mostly SAMD21 ("M0") boards without an external flash chip, such as the Adafruit Gemma M0, Trinket M0, QT Py M0, and the Trinky series. There are also a number of third-party boards in this category. There are also a few small STM third-party boards without long integer support.

`time.localtime()`, `time.mktime()`, `time.time()`, and `time.monotonic_ns()` are available only on builds with long integers.

---



## Wireless Connectivity

---

### How do I connect to the Internet with CircuitPython?

If you'd like to include WiFi in your project, your best bet is to use a board that is running natively on ESP32 chipsets - those have WiFi built in!

If your development board has an SPI port and at least 4 additional pins, you can check out [this guide](#) () on using AirLift with CircuitPython - extra wiring is required and some boards like the MacroPad or NeoTrellis do not have enough available pins to add the hardware support.

For further project examples, and guides about using AirLift with specific hardware, check out [the Adafruit Learn System](#) ().

---

### How do I do BLE (Bluetooth Low Energy) with CircuitPython?

The nRF52840 and nRF52833 boards have the most complete BLE implementation. Your program can act as both a BLE central and peripheral. As a central, you can scan for advertisements, and connect to an advertising board. As a peripheral, you can advertise, and you can create services available to a central. Pairing and bonding are supported.

ESP32-C3 and ESP32-S3 boards currently provide an [incomplete](#) () BLE implementation. Your program can act as a central, and connect to a peripheral. You can advertise, but you cannot create services. You cannot advertise anonymously. Pairing and bonding are not supported.

The ESP32 could provide a similar implementation, but it is not yet available. Note that the ESP32-S2 does not have Bluetooth capability.

On most other boards with adequate firmware space, [BLE is available for use with AirLift](#) () or other NINA-FW-based co-processors. Some boards have this coprocessor on board, such as the [PyPortal](#) (). Currently, this implementation only supports acting as a BLE peripheral. Scanning and connecting as a central are not yet implemented. Bonding and pairing are not supported.

---

## Are there other ways to communicate by radio with CircuitPython?

---

Check out [Adafruit's RFM boards](#) () for simple radio communication supported by CircuitPython, which can be used over distances of 100m to over a km, depending on the version. The RFM SAMD21 M0 boards can be used, but they were not designed for CircuitPython, and have limited RAM and flash space; using the RFM breakouts or FeatherWings with more capable boards will be easier.

---

## Asyncio and Interrupts

---

### Is there asyncio support in CircuitPython?

There is support for asyncio starting with CircuitPython 7.1.0, on all boards except the smallest SAMD21 builds. Read about using it in the [Cooperative Multitasking in CircuitPython \(\)](#) Guide.

---

### Does CircuitPython support interrupts?

No. CircuitPython does not currently support interrupts - please use asyncio for multitasking / 'threaded' control of your code

---

## Status RGB LED

---

### My RGB NeoPixel/DotStar LED is blinking funny colors - what does it mean?

The status LED can tell you what's going on with your CircuitPython board. [Read more here for what the colors mean!](#) ()

---

## Memory Issues

---

### What is a MemoryError?

Memory allocation errors happen when you're trying to store too much on the board. The CircuitPython microcontroller boards have a limited amount of memory available. You can have about 250 lines of code on the M0 Express boards. If you try to `import` too many libraries, a combination of large libraries, or run a program with too many lines of code, your code will fail to run and you will receive a `MemoryError` in the serial console.

---

## What do I do when I encounter a MemoryError?

Try resetting your board. Each time you reset the board, it reallocates the memory. While this is unlikely to resolve your issue, it's a simple step and is worth trying.

Make sure you are using .mpy versions of libraries. All of the CircuitPython libraries are available in the bundle in a .mpy format which takes up less memory than .py format. Be sure that you're using [the latest library bundle \(\)](#) for your version of CircuitPython.

If that does not resolve your issue, try shortening your code. Shorten comments, remove extraneous or unneeded code, or any other clean up you can do to shorten your code. If you're using a lot of functions, you could try moving those into a separate library, creating a .mpy of that library, and importing it into your code.

You can turn your entire file into a .mpy and `import` that into code.py. This means you will be unable to edit your code live on the board, but it can save you space.

---

## Can the order of my `import` statements affect memory?

It can because the memory gets fragmented differently depending on allocation order and the size of objects. Loading .mpy files uses less memory so its recommended to do that for files you aren't editing.

---

## How can I create my own .mpy files?

You can make your own .mpy versions of files with `mpy-cross`.

You can download `mpy-cross` for your operating system from [here \(\)](#). Builds are available for Windows, macOS, x64 Linux, and Raspberry Pi Linux. Choose the latest `mpy-cross` whose version matches the version of CircuitPython you are using.

To make a .mpy file, run `./mpy-cross path/to/yourfile.py` to create a yourfile.mpy in the same directory as the original file.

---

## How do I check how much memory I have free?

Run the following to see the number of bytes available for use:

```
import gc
gc.mem_free()
```

---

## Unsupported Hardware

---

### Is ESP8266 or ESP32 supported in CircuitPython? Why not?

We dropped ESP8266 support as of 4.x - For more information please read about it [here](#) ()!

As of CircuitPython 8.x we have started to support ESP32 and ESP32-C3 and have added a WiFi workflow for wireless coding! ()

We also support ESP32-S2 & ESP32-S3, which have native USB.

---

### Does Feather M0 support WINC1500?

No, WINC1500 will not fit into the M0 flash space.

---

### Can AVR's such as ATmega328 or ATmega2560 run CircuitPython?

No.

---

## ESP32-S2 Bugs & Limitations

Nobody likes bugs, but all nontrivial software and hardware has some. The master list of problems is the [Issues list on github](#) ().

Adafruit considers CircuitPython for the ESP32-S2 to be beta quality software.

---

### I2C at 100 kHz bus frequency runs slowly

The default I2C bus clock speed is 100 kHz (100000) . At that rate, the ESP32-S2 [will leave 10ms](#) () gaps between I2C transactions. This can slow down your I2C interactions considerably, such as when you are controlling a stepper motor with a PCA9685 controller.

Raising the I2C bus frequency to 125 kHz (125000) or higher fixes this problem. If your I2C peripheral can handle higher frequencies, you can use 400 kHz (400000) or even in some cases 1 MHz (1000000).

Note that `board.I2C()` creates an I2C bus that runs at 100 kHz. The bus frequency cannot be changed.. To create an I2C bus on the default I2C pins that runs at a different frequency, you must use `busio.I2C(board.SCL, board.SDA, frequency=)`.

---

## No DAC-based audio output

Current versions of the ESP-IDF SDK do not have the required APIs for DAC-based audio output. Once a future version of ESP-IDF that adds it, it will be possible to implement DAC-based AudioOut in CircuitPython.

Workaround: PWMOut can create tones and buzzes.

Workaround: I2SOut audio is currently being developed and will work with boards such as the [Adafruit I2S Stereo Decoder - UDA1334A Breakout \(\)](#).

---

## Deep Sleep & Wake-up sources

ESP32-S2 has hardware limitations on what kind of "pin alarms" can wake it. The following combinations are possible:

- EITHER one or two pins that wake from deep sleep when they are pulled LOW
- OR an arbitrary number of pins that wake from deep sleep when they are pulled HIGH, and optionally one pin that wakes from deep sleep when pulled LOW

This means that "wake" buttons should be wired so that pressing them pulls HIGH and a pull DOWN resistor is used with the pin. However, in some hardware designs including the original MagTag, the integrated buttons are pulled LOW when pressed and so only 1 or 2 buttons can be selected to wake the MagTag.

---

## Troubleshooting

From time to time, you will run into issues when working with CircuitPython. Here are a few things you may encounter and how to resolve them.

As CircuitPython development continues and there are new releases, Adafruit will stop supporting older releases. Visit <https://circuitpython.org/downloads> to download the latest version of CircuitPython for your board. You must download the CircuitPython Library Bundle that matches your version of CircuitPython. Please update CircuitPython and then visit <https://circuitpython.org/libraries> to download the latest Library Bundle.

## Always Run the Latest Version of CircuitPython and Libraries

As CircuitPython development continues and there are new releases, Adafruit will stop supporting older releases. You need to [update to the latest CircuitPython. \(\)](#).

You need to download the CircuitPython Library Bundle that matches your version of CircuitPython. Please update CircuitPython and then [download the latest bundle \(\)](#).

As new versions of CircuitPython are released, Adafruit will stop providing the previous bundles as automatically created downloads on the Adafruit CircuitPython Library Bundle repo. If you must continue to use an earlier version, you can still download the appropriate version of `mpy-cross` from the particular release of CircuitPython on the CircuitPython repo and create your own compatible `.mpy` library files. However, it is best to update to the latest for both CircuitPython and the library bundle.

### I have to continue using CircuitPython 5.x or earlier. Where can I find compatible libraries?

Adafruit is no longer building or supporting the CircuitPython 5.x or earlier library bundles. You are highly encouraged to [update CircuitPython to the latest version \(\)](#) and use [the current version of the libraries \(\)](#). However, if for some reason you cannot update, links to the previous bundles are available in the [FAQ \(\)](#).

# Bootloader (boardnameBOOT) Drive Not Present

You may have a different board.

Only Adafruit Express boards and the SAMD21 non-Express boards ship with the [UF2 bootloader](#) () installed. The Feather M0 Basic, Feather M0 Adalogger, and similar boards use a regular Arduino-compatible bootloader, which does not show a boardnameBOOT drive.

## MakeCode

If you are running a [MakeCode](#) () program on Circuit Playground Express, press the reset button just once to get the CPLAYBOOT drive to show up. Pressing it twice will not work.

## MacOS

DriveDx and its accompanying SAT SMART Driver can interfere with seeing the BOOT drive. [See this forum post](#) () for how to fix the problem.

## Windows 10

Did you install the Adafruit Windows Drivers package by mistake, or did you upgrade to Windows 10 with the driver package installed? You don't need to install this package on Windows 10 for most Adafruit boards. The old version (v1.5) can interfere with recognizing your device. Go to Settings -> Apps and uninstall all the "Adafruit" driver programs.

## Windows 7 or 8.1

To use a CircuitPython-compatible board with Windows 7 or 8.1, you must install a driver. Installation instructions are available [here](#) ().

It is [recommended](#) () that you upgrade to Windows 10 if possible; an upgrade is probably still free for you. Check [here](#) ().

The Windows Drivers installer was last updated in November 2020 (v2.5.0.0) . Windows 7 drivers for CircuitPython boards released since then, including RP2040 boards, are not yet available. The boards work fine on Windows 10. A new release of the drivers is in process.

You should now be done! Test by unplugging and replugging the board. You should see the CIRCUITPY drive, and when you double-click the reset button (single click on Circuit Playground Express running MakeCode), you should see the appropriate boardnameBOOT drive.

Let us know in the [Adafruit support forums \(\)](#) or on the [Adafruit Discord \(\)](#) if this does not work for you!

## Windows Explorer Locks Up When Accessing boardnameBOOT Drive

On Windows, several third-party programs that can cause issues. The symptom is that you try to access the boardnameBOOT drive, and Windows or Windows Explorer seems to lock up. These programs are known to cause trouble:

- AIDA64: to fix, stop the program. This problem has been reported to AIDA64. They acquired hardware to test, and released a beta version that fixes the problem. This may have been incorporated into the latest release. Please let us know in the forums if you test this.
- Hard Disk Sentinel
- Kaspersky anti-virus: To fix, you may need to disable Kaspersky completely. Disabling some aspects of Kaspersky does not always solve the problem. This problem has been reported to Kaspersky.
- ESET NOD32 anti-virus: There have been problems with at least version 9.0.386.0, solved by uninstallation.

## Copying UF2 to boardnameBOOT Drive Hangs at 0% Copied

On Windows, a Western Digital (WD) utility that comes with their external USB drives can interfere with copying UF2 files to the boardnameBOOT drive. Uninstall that utility to fix the problem.



# CIRCUITPY Drive Does Not Appear or Disappears Quickly

Kaspersky anti-virus can block the appearance of the CIRCUITPY drive. There has not yet been settings change discovered that prevents this. Complete uninstallation of Kaspersky fixes the problem.

Norton anti-virus can interfere with CIRCUITPY. A user has reported this problem on Windows 7. The user turned off both Smart Firewall and Auto Protect, and CIRCUITPY then appeared.

Sophos Endpoint security software [can cause CIRCUITPY to disappear \(\)](#) and the BOOT drive to reappear. It is not clear what causes this behavior.

## Device Errors or Problems on Windows

Windows can become confused about USB device installations. This is particularly true of Windows 7 and 8.1. It is [recommended \(\)](#) that you upgrade to Windows 10 if possible; an upgrade is probably still free for you: see this [link \(\)](#).

If not, try cleaning up your USB devices. Use [Uwe Sieber's Device Cleanup Tool \(\)](#) (on that page, scroll down to "Device Cleanup Tool"). Download and unzip the tool. Unplug all the boards and other USB devices you want to clean up. Run the tool as Administrator. You will see a listing like this, probably with many more devices. It is listing all the USB devices that are not currently attached.

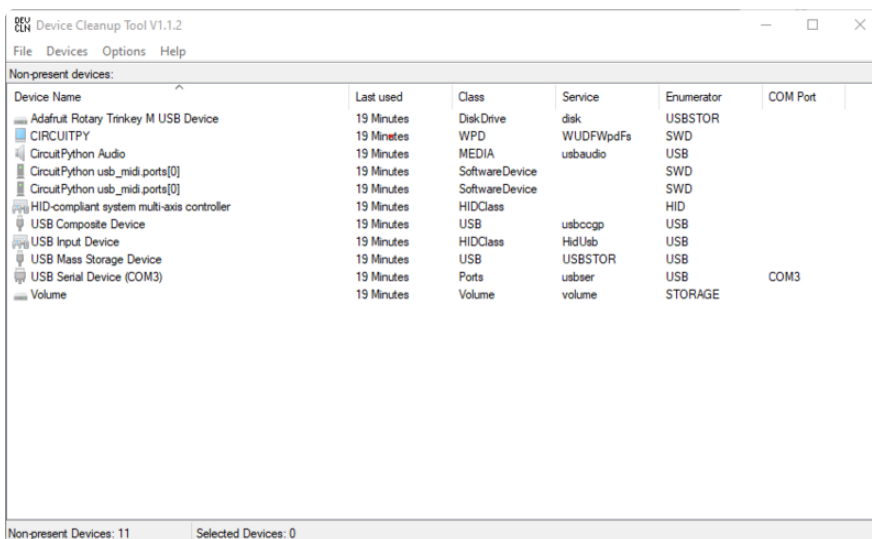

Select all the devices you want to remove, and then press Delete. It is usually safe just to select everything. Any device that is removed will get a fresh install when you plug it in. Using the Device Cleanup Tool also discards all the COM port assignments for the unplugged boards. If you have used many Arduino and CircuitPython boards, you have probably seen higher and higher COM port numbers used, seemingly without end. This will fix that problem.

## Serial Console in Mu Not Displaying Anything

There are times when the serial console will accurately not display anything, such as, when no code is currently running, or when code with no serial output is already running before you open the console. However, if you find yourself in a situation where you feel it should be displaying something like an error, consider the following.

Depending on the size of your screen or Mu window, when you open the serial console, the serial console panel may be very small. This can be a problem. A basic CircuitPython error takes 10 lines to display!

```
Auto-reload is on. Simply save files over USB to run them or enter REPL to disable.
code.py output:
Traceback (most recent call last):
  File "code.py", line 7
SyntaxError: invalid syntax
```

```
Press any key to enter the REPL. Use CTRL-D to reload.
```

More complex errors take even more lines!

Therefore, if your serial console panel is five lines tall or less, you may only see blank lines or blank lines followed by **Press any key to enter the REPL. Use CTRL-D to reload.** . If this is the case, you need to either mouse over the top of the panel to utilise the option to resize the serial panel, or use the scrollbar on the right side to scroll up and find your message.

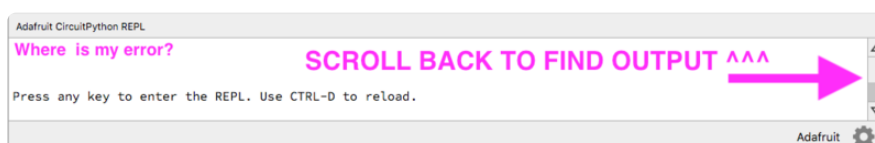

This applies to any kind of serial output whether it be error messages or print statements. So before you start trying to debug your problem on the hardware side,

be sure to check that you haven't simply missed the serial messages due to serial output panel height.

## code.py Restarts Constantly

CircuitPython will restart code.py if you or your computer writes to something on the CIRCUITPY drive. This feature is called auto-reload, and lets you test a change to your program immediately.

Some utility programs, such as backup, anti-virus, or disk-checking apps, will write to the CIRCUITPY as part of their operation. Sometimes they do this very frequently, causing constant restarts.

Acronis True Image and related Acronis programs on Windows are known to cause this problem. It is possible to prevent this by [disabling the " \(\)Acronis Managed Machine Service Mini" \(\)](#).

If you cannot stop whatever is causing the writes, you can disable auto-reload by putting this code in boot.py or code.py:

```
import supervisor
supervisor.disable_autoreload()
```

## CircuitPython RGB Status Light

Nearly all CircuitPython-capable boards have a single NeoPixel or DotStar RGB LED on the board that indicates the status of CircuitPython. A few boards designed before CircuitPython existed, such as the Feather M0 Basic, do not.

Circuit Playground Express and Circuit Playground Bluefruit have multiple RGB LEDs, but do NOT have a status LED. The LEDs are all green when in the bootloader. In versions before 7.0.0, they do NOT indicate any status while running CircuitPython.

## CircuitPython 7.0.0 and Later

The status LED blinks were changed in CircuitPython 7.0.0 in order to save battery power and simplify the blinks. These blink patterns will occur on single color LEDs when the board does not have any RGB LEDs. Speed and blink count also vary for this reason.

On start up, the LED will blink YELLOW multiple times for 1 second. Pressing the RESET button (or on Espressif, the BOOT button) during this time will restart the board and then enter safe mode. On Bluetooth capable boards, after the yellow blinks, there will be a set of faster blue blinks. Pressing reset during the BLUE blinks will clear Bluetooth information and start the device in discoverable mode, so it can be used with a BLE code editor.

Once started, CircuitPython will blink a pattern every 5 seconds when no user code is running to indicate why the code stopped:

- 1 GREEN blink: Code finished without error.
- 2 RED blinks: Code ended due to an exception. Check the serial console for details.
- 3 YELLOW blinks: CircuitPython is in safe mode. No user code was run. Check the serial console for safe mode reason.

When in the REPL, CircuitPython will set the status LED to WHITE. You can change the LED color from the REPL. The status indicator will not persist on non-NeoPixel or DotStar LEDs.

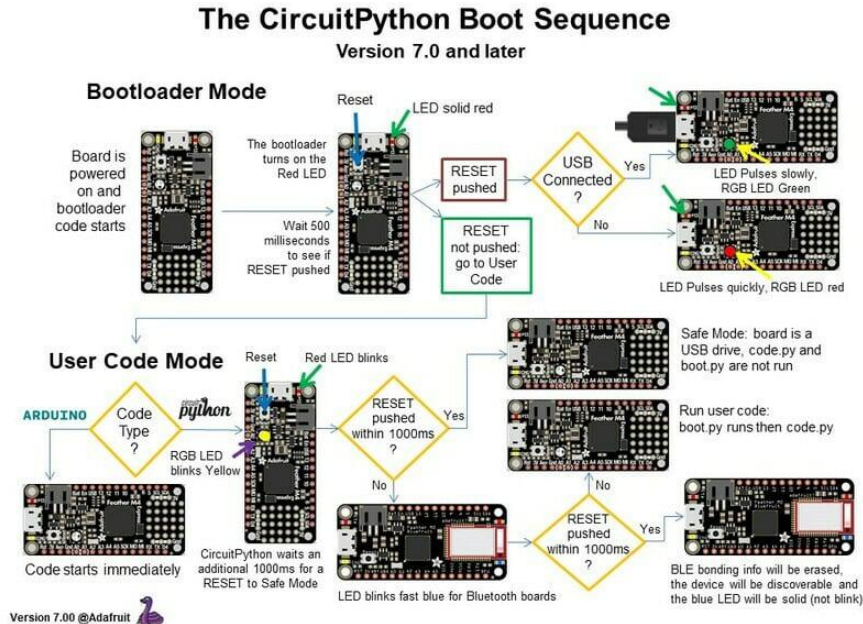

## CircuitPython 6.3.0 and earlier

Here's what the colors and blinking mean:

- steady GREEN: code.py (or code.txt, main.py, or main.txt) is running

- pulsing GREEN: code.py (etc.) has finished or does not exist
- steady YELLOW at start up: (4.0.0-alpha.5 and newer) CircuitPython is waiting for a reset to indicate that it should start in safe mode
- pulsing YELLOW: Circuit Python is in safe mode: it crashed and restarted
- steady WHITE: REPL is running
- steady BLUE: boot.py is running

Colors with multiple flashes following indicate a Python exception and then indicate the line number of the error. The color of the first flash indicates the type of error:

- GREEN: IndentationError
- CYAN: SyntaxError
- WHITE: NameError
- ORANGE: OSError
- PURPLE: ValueError
- YELLOW: other error

These are followed by flashes indicating the line number, including place value. WHITE E flashes are thousands' place, BLUE are hundreds' place, YELLOW are tens' place, and CYAN are one's place. So for example, an error on line 32 would flash YELLOW three times and then CYAN two times. Zeroes are indicated by an extra-long dark gap.

### The CircuitPython Boot Sequence

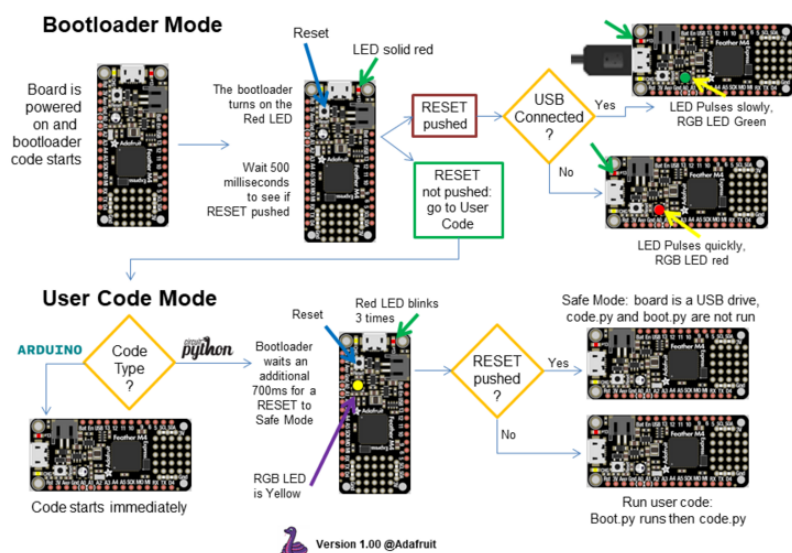

## Serial console showing `ValueError: Incompatible .mpy file`

This error occurs when importing a module that is stored as a .mpy binary file that was generated by a different version of CircuitPython than the one its being loaded into. In particular, the mpy binary format changed between CircuitPython versions 6.x and 7.x, 2.x and 3.x, and 1.x and 2.x.

So, for instance, if you upgraded to CircuitPython 7.x from 6.x you'll need to download a newer version of the library that triggered the error on `import`. All libraries are available in the [Adafruit bundle \(\)](#).

## CIRCUITPY Drive Issues

You may find that you can no longer save files to your CIRCUITPY drive. You may find that your CIRCUITPY stops showing up in your file explorer, or shows up as NO\_NAME. These are indicators that your filesystem has issues. When the CIRCUITPY disk is not safely ejected before being reset by the button or being disconnected from USB, it may corrupt the flash drive. It can happen on Windows, Mac or Linux, though it is more common on Windows.

Be aware, if you have used Arduino to program your board, CircuitPython is no longer able to provide the USB services. You will need to reload CircuitPython to resolve this situation.

The easiest first step is to reload CircuitPython. Double-tap reset on the board so you get a boardnameBOOT drive rather than a CIRCUITPY drive, and copy the latest version of CircuitPython (.uf2) back to the board. This may restore CIRCUITPY functionality.

If reloading CircuitPython does not resolve your issue, the next step is to try putting the board into safe mode.

## Safe Mode

Whether you've run into a situation where you can no longer edit your code.py on your CIRCUITPY drive, your board has gotten into a state where CIRCUITPY is read-only, or you have turned off the CIRCUITPY drive altogether, safe mode can help.

Safe mode in CircuitPython does not run any user code on startup, and disables auto-reload. This means a few things. First, safe mode bypasses any code in `boot.py` (where you can set `CIRCUITPY` read-only or turn it off completely). Second, it does not run the code in `code.py`. And finally, it does not automatically soft-reload when data is written to the `CIRCUITPY` drive.

Therefore, whatever you may have done to put your board in a non-interactive state, safe mode gives you the opportunity to correct it without losing all of the data on the `CIRCUITPY` drive.

## Entering Safe Mode in CircuitPython 7.x and Later

To enter safe mode when using CircuitPython 7.x, plug in your board or hit reset (highlighted in red above). Immediately after the board starts up or resets, it waits 1000ms. On some boards, the onboard status LED will blink yellow during that time. If you press reset during that 1000ms, the board will start up in safe mode. It can be difficult to react to the yellow LED, so you may want to think of it simply as a "slow" double click of the reset button. (Remember, a fast double click of reset enters the bootloader.)

## Entering Safe Mode in CircuitPython 6.x

To enter safe mode when using CircuitPython 6.x, plug in your board or hit reset (highlighted in red above). Immediately after the board starts up or resets, it waits 700ms. On some boards, the onboard status LED (highlighted in green above) will turn solid yellow during this time. If you press reset during that 700ms, the board will start up in safe mode. It can be difficult to react to the yellow LED, so you may want to think of it simply as a slow double click of the reset button. (Remember, a fast double click of reset enters the bootloader.)

## In Safe Mode

Once you've entered safe mode successfully in CircuitPython 6.x, the LED will pulse yellow.

If you successfully enter safe mode on CircuitPython 7.x, the LED will intermittently blink yellow three times.

If you connect to the serial console, you'll find the following message.

```
Auto-reload is off.  
Running in safe mode! Not running saved code.  
  
CircuitPython is in safe mode because you pressed the reset button during boot.  
Press again to exit safe mode.  
  
Press any key to enter the REPL. Use CTRL-D to reload.
```

You can now edit the contents of the CIRCUITPY drive. Remember, your code will not run until you press the reset button, or unplug and plug in your board, to get out of safe mode.

At this point, you'll want to remove any user code in code.py and, if present, the boot.py file from CIRCUITPY. Once removed, tap the reset button, or unplug and plug in your board, to restart CircuitPython. This will restart the board and may resolve your drive issues. If resolved, you can begin coding again as usual.

If safe mode does not resolve your issue, the board must be completely erased and CircuitPython must be reloaded onto the board.

You WILL lose everything on the board when you complete the following steps. If possible, make a copy of your code before continuing.

To erase CIRCUITPY: `storage.erase_filesystem()`

CircuitPython includes a built-in function to erase and reformat the filesystem. If you have a version of CircuitPython older than 2.3.0 on your board, you can [update to the newest version \(\)](#) to do this.

1. [Connect to the CircuitPython REPL \(\)](#) using Mu or a terminal program.
2. Type the following into the REPL:

```
>>> import storage  
>>> storage.erase_filesystem()
```

CIRCUITPY will be erased and reformatted, and your board will restart. That's it!

## Erase CIRCUITPY Without Access to the REPL

If you can't access the REPL, or you're running a version of CircuitPython previous to 2.3.0 and you don't want to upgrade, there are options available for some specific boards.



The options listed below are considered to be the "old way" of erasing your board. The method shown above using the REPL is highly recommended as the best method for erasing your board.

If at all possible, it is recommended to use the REPL to erase your CIRCUITPY drive. The REPL method is explained above.

## For the specific boards listed below:

If the board you are trying to erase is listed below, follow the steps to use the file to erase your board.

1. Download the correct erase file:

Circuit Playground Express

Feather M0 Express

Feather M4 Express

Metro M0 Express

Metro M4 Express QSPI Eraser

Trellis M4 Express (QSPI)

Grand Central M4 Express (QSPI)

PyPortal M4 Express (QSPI)

Circuit Playground Bluefruit (QSPI)

Monster M4SK (QSPI)

PyBadge/PyGamer QSPI Eraser.UF2

CLUE\_Flash\_Erase.UF2

Matrix\_Portal\_M4\_(QSPI).UF2

2. Double-click the reset button on the board to bring up the boardnameBOOT drive.
3. Drag the erase .uf2 file to the boardnameBOOT drive.
4. The status LED will turn yellow or blue, indicating the erase has started.
5. After approximately 15 seconds, the status LED will light up green. On the NeoTrellis M4 this is the first NeoPixel on the grid
6. Double-click the reset button on the board to bring up the boardnameBOOT drive.
7. [Drag the appropriate latest release of CircuitPython \(\)](#) .uf2 file to the boardnameBOOT drive.

It should reboot automatically and you should see CIRCUITPY in your file explorer again.

If the LED flashes red during step 5, it means the erase has failed. Repeat the steps starting with 2.

[If you haven't already downloaded the latest release of CircuitPython for your board, check out the installation page \(\)](#). You'll also need to load your code and reinstall your libraries!

## For SAMD21 non-Express boards that have a UF2 bootloader:

Any SAMD21-based microcontroller that does not have external flash available is considered a SAMD21 non-Express board. Non-Express boards that have a UF2 bootloader include Trinket M0, GEMMA M0, QT Py M0, and the SAMD21-based Trinkey boards.

If you are trying to erase a SAMD21 non-Express board, follow these steps to erase your board.

1. Download the erase file:

SAMD21 non-Express Boards

2. Double-click the reset button on the board to bring up the boardnameBOOT drive.
3. Drag the erase .uf2 file to the boardnameBOOT drive.
4. The boot LED will start flashing again, and the boardnameBOOT drive will reappear.
5. [Drag the appropriate latest release CircuitPython \(\)](#) .uf2 file to the boardnameBOOT drive.

It should reboot automatically and you should see CIRCUITPY in your file explorer again.

[If you haven't already downloaded the latest release of CircuitPython for your board, check out the installation page \(\)](#) You'll also need to load your code and reinstall your libraries!

## For SAMD21 non-Express boards that do not have a UF2 bootloader:

Any SAMD21-based microcontroller that does not have external flash available is considered a SAMD21 non-Express board. Non-Express boards that do not have a UF2 bootloader include the Feather M0 Basic Proto, Feather Adalogger, or the Arduino Zero.

If you are trying to erase a non-Express board that does not have a UF2 bootloader, [follow these directions to reload CircuitPython using bossac \(\)](#), which will erase and re-create CIRCUITPY.

## Running Out of File Space on SAMD21 Non-Express Boards

Any SAMD21-based microcontroller that does not have external flash available is considered a SAMD21 non-Express board. This includes boards like the Trinket M0, GEMMA M0, QT Py M0, and the SAMD21-based Trinkey boards.

The file system on the board is very tiny. (Smaller than an ancient floppy disk.) So, its likely you'll run out of space but don't panic! There are a number of ways to free up space.

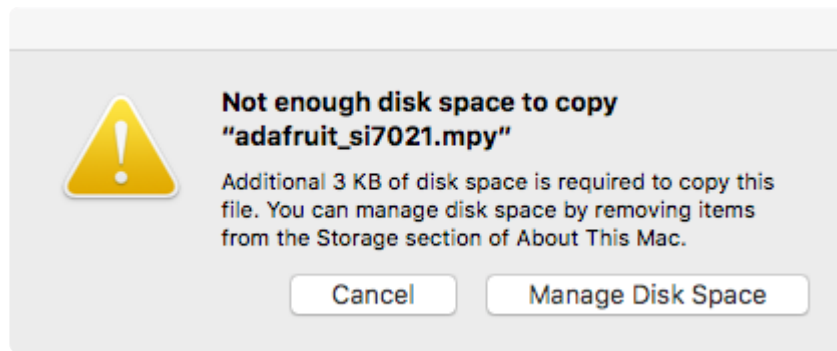

## Delete something!

The simplest way of freeing up space is to delete files from the drive. Perhaps there are libraries in the lib folder that you aren't using anymore or test code that isn't in use. Don't delete the lib folder completely, though, just remove what you don't need.

The board ships with the Windows 7 serial driver too! Feel free to delete that if you don't need it or have already installed it. It's ~12KiB or so.

## Use tabs

One unique feature of Python is that the indentation of code matters. Usually the recommendation is to indent code with four spaces for every indent. In general, that is recommended too. However, one trick to storing more human-readable code is to use a single tab character for indentation. This approach uses 1/4 of the space for indentation and can be significant when you're counting bytes.

## On MacOS?

MacOS loves to generate hidden files. Luckily you can disable some of the extra hidden files that macOS adds by running a few commands to disable search indexing and create zero byte placeholders. Follow the steps below to maximize the amount of space available on macOS.

## Prevent & Remove MacOS Hidden Files

First find the volume name for your board. With the board plugged in run this command in a terminal to list all the volumes:

```
ls -l /Volumes
```

Look for a volume with a name like CIRCUITPY (the default for CircuitPython). The full path to the volume is the /Volumes/CIRCUITPY path.

Now follow the [steps from this question \(\)](#) to run these terminal commands that stop hidden files from being created on the board:

```
mdutil -i off /Volumes/CIRCUITPY
cd /Volumes/CIRCUITPY
rm -rf .{,_.}{fseventsd,Spotlight-V*,Trashes}
mkdir .fseventsd
touch .fseventsd/no_log .metadata_never_index .Trashes
cd -
```

Replace /Volumes/CIRCUITPY in the commands above with the full path to your board's volume if it's different. At this point all the hidden files should be cleared from the board and some hidden files will be prevented from being created.

Alternatively, with CircuitPython 4.x and above, the special files and folders mentioned above will be created automatically if you erase and reformat the filesystem. WARNING: Save your files first! Do this in the REPL:

```
>>> import storage
>>> storage.erase_filesystem()
```

However there are still some cases where hidden files will be created by MacOS. In particular if you copy a file that was downloaded from the internet it will have special metadata that MacOS stores as a hidden file. Luckily you can run a copy command from the terminal to copy files without this hidden metadata file. See the steps below.

## Copy Files on MacOS Without Creating Hidden Files

Once you've disabled and removed hidden files with the above commands on macOS you need to be careful to copy files to the board with a special command that prevents future hidden files from being created. Unfortunately you cannot use drag and drop copy in Finder because it will still create these hidden extended attribute files in some cases (for files downloaded from the internet, like Adafruit's modules).

To copy a file or folder use the -X option for the cp command in a terminal. For example to copy a file\_name.mpy file to the board use a command like:

```
cp -X file_name.mpy /Volumes/CIRCUITPY
```

(Replace file\_name.mpy with the name of the file you want to copy.)

Or to copy a folder and all of the files and folders contained within, use a command like:

```
cp -rX folder_to_copy /Volumes/CIRCUITPY
```

If you are copying to the lib folder, or another folder, make sure it exists before copying.

```
# if lib does not exist, you'll create a file named lib !
cp -X file_name.mpy /Volumes/CIRCUITPY/lib
# This is safer, and will complain if a lib folder does not exist.
cp -X file_name.mpy /Volumes/CIRCUITPY/lib/
```

## Other MacOS Space-Saving Tips

If you'd like to see the amount of space used on the drive and manually delete hidden files here's how to do so. First, move into the Volumes/ directory with `cd /Volumes/`, and then list the amount of space used on the CIRCUITPY drive with the `df` command.

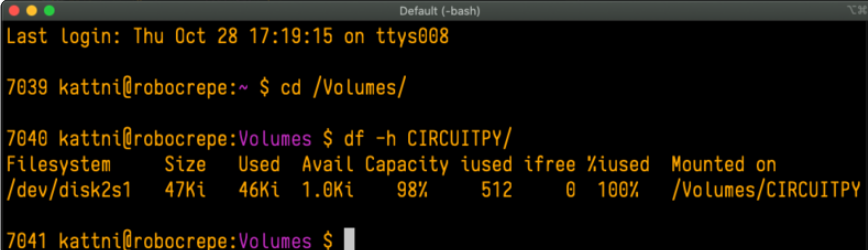

```
Default (-bash)
Last login: Thu Oct 28 17:19:15 on ttys008

7039 kattni@robocrepe:~ $ cd /Volumes/

7040 kattni@robocrepe:Volumes $ df -h CIRCUITPY/
Filesystem      Size  Used Avail Capacity iused ifree %used  Mounted on
/dev/disk2s1    47Ki  46Ki  1.0Ki   98%    512     0 100%  /Volumes/CIRCUITPY

7041 kattni@robocrepe:Volumes $
```

That's not very much space left! The next step is to show a list of the files currently on the CIRCUITPY drive, including the hidden files, using the `ls` command. You cannot use Finder to do this, you must do it via command line!

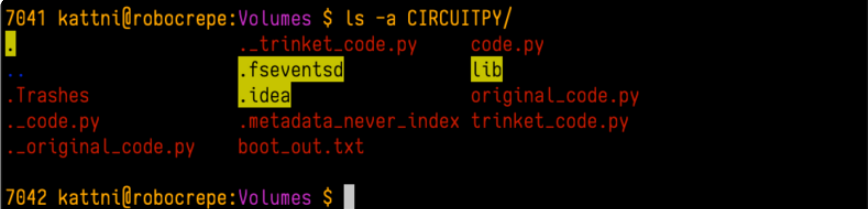

```
7041 kattni@robocrepe:Volumes $ ls -a CIRCUITPY/
.
..
._trinket_code.py  code.py
.fseventsd        lib
.Trashes          .idea          original_code.py
._code.py         .metadata_never_index  trinket_code.py
._original_code.py  boot_out.txt

7042 kattni@robocrepe:Volumes $
```

There are a few of the hidden files that MacOS loves to generate, all of which begin with a `._` before the file name. Remove the `._` files using the `rm` command. You can

remove them all once by running `rm CIRCUITPY/.*`. The `*` acts as a wildcard to apply the command to everything that begins with `._` at the same time.

```
7042 kattni@robocrepe:Volumes $ rm CIRCUITPY/.*
7043 kattni@robocrepe:Volumes $
```

Finally, you can run `df` again to see the current space used.

```
7043 kattni@robocrepe:Volumes $ df -h CIRCUITPY/
Filesystem      Size  Used Avail Capacity  iused ifree %iused  Mounted on
/dev/disk2s1    47Ki  34Ki  13Ki    73%     512     0 100%  /Volumes/CIRCUITPY

7044 kattni@robocrepe:Volumes $
```

Nice! You have 12Ki more than before! This space can now be used for libraries and code!

## Device Locked Up or Boot Looping

In rare cases, it may happen that something in your `code.py` or `boot.py` files causes the device to get locked up, or even go into a boot loop. A boot loop occurs when the board reboots repeatedly and never fully loads. These are not caused by your everyday Python exceptions, typically it's the result of a deeper problem within CircuitPython. In this situation, it can be difficult to recover your device if CIRCUITPY is not allowing you to modify the `code.py` or `boot.py` files. Safe mode is one recovery option. When the device boots up in safe mode it will not run the `code.py` or `boot.py` scripts, but will still connect the CIRCUITPY drive so that you can remove or modify those files as needed.

The method used to manually enter safe mode can be different for different devices. It is also very similar to the method used for getting into bootloader mode, which is a different thing. So it can take a few tries to get the timing right. If you end up in bootloader mode, no problem, you can try again without needing to do anything else.

For most devices:

Press the reset button, and then when the RGB status LED blinks yellow, press the reset button again. Since your reaction time may not be that fast, try a "slow" double click, to catch the yellow LED on the second click.

For ESP32-S2 based devices:

Press and release the reset button, then press and release the boot button about 3/4 of a second later.

Refer to the diagrams above for boot sequence details.

---

## Welcome to the Community!

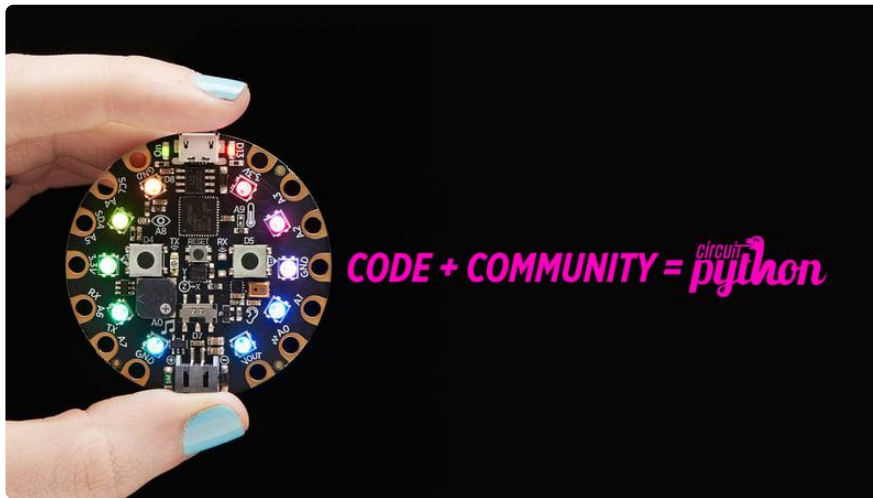

CircuitPython is a programming language that's super simple to get started with and great for learning. It runs on microcontrollers and works out of the box. You can plug it in and get started with any text editor. The best part? CircuitPython comes with an amazing, supportive community.

Everyone is welcome! CircuitPython is Open Source. This means it's available for anyone to use, edit, copy and improve upon. This also means CircuitPython becomes better because of you being a part of it. Whether this is your first microcontroller board or you're a seasoned software engineer, you have something important to offer the Adafruit CircuitPython community. This page highlights some of the many ways you can be a part of it!



# Adafruit Discord

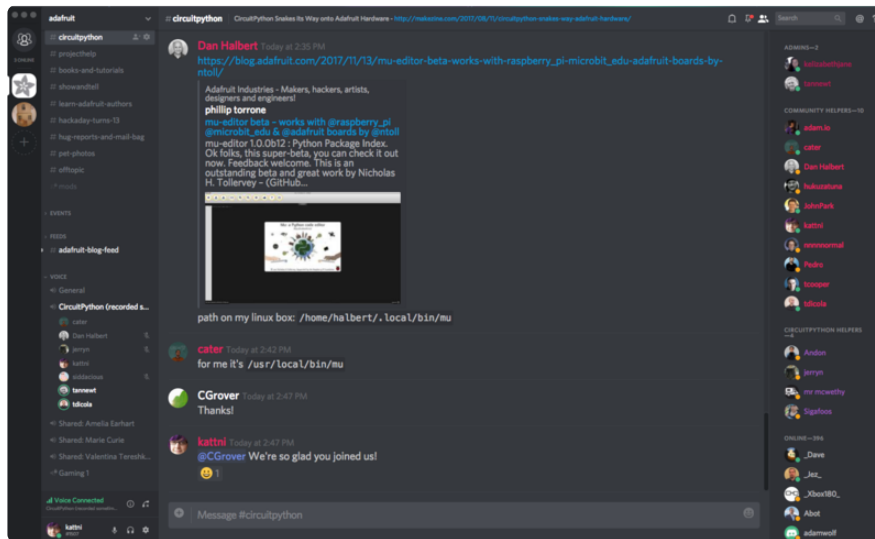

The Adafruit Discord server is the best place to start. Discord is where the community comes together to volunteer and provide live support of all kinds. From general discussion to detailed problem solving, and everything in between, Discord is a digital maker space with makers from around the world.

There are many different channels so you can choose the one best suited to your needs. Each channel is shown on Discord as "#channelname". There's the #help-with-projects channel for assistance with your current project or help coming up with ideas for your next one. There's the #show-and-tell channel for showing off your newest creation. Don't be afraid to ask a question in any channel! If you're unsure, #general is a great place to start. If another channel is more likely to provide you with a better answer, someone will guide you.

The help with CircuitPython channel is where to go with your CircuitPython questions. #help-with-circuitpython is there for new users and developers alike so feel free to ask a question or post a comment! Everyone of any experience level is welcome to join in on the conversation. Your contributions are important! The #circuitpython-dev channel is available for development discussions as well.

The easiest way to contribute to the community is to assist others on Discord. Supporting others doesn't always mean answering questions. Join in celebrating successes! Celebrate your mistakes! Sometimes just hearing that someone else has gone through a similar struggle can be enough to keep a maker moving forward.

The Adafruit Discord is the 24x7x365 hackerspace that you can bring your granddaughter to.

Visit <https://adafru.it/discord> () to sign up for Discord. Everyone is looking forward to meeting you!

## CircuitPython.org

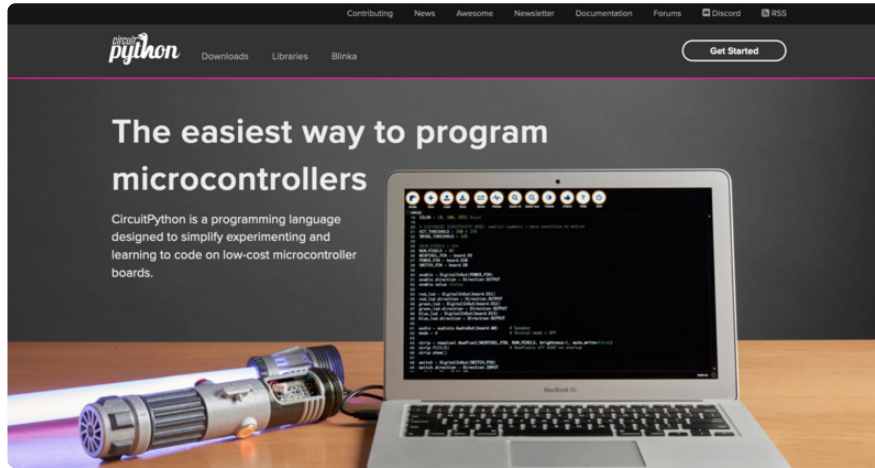

Beyond the Adafruit Learn System, which you are viewing right now, the best place to find information about CircuitPython is [circuitpython.org](https://circuitpython.org) (). Everything you need to get started with your new microcontroller and beyond is available. You can do things like [download CircuitPython for your microcontroller](#) () or [download the latest CircuitPython Library bundle](#) (), or check out [which single board computers support Blinka](#) (). You can also get to various other CircuitPython related things like Awesome CircuitPython or the Python for Microcontrollers newsletter. This is all incredibly useful, but it isn't necessarily community related. So why is it included here? The [Contributing page](#) ().

### Contributing

If you'd like to contribute to the CircuitPython project, the CircuitPython libraries are a great way to begin. This page is updated with daily status information from the CircuitPython libraries, including open pull requests, open issues and library infrastructure issues.

Do you write a language other than English? Another great way to contribute to the project is to contribute new localizations (translations) of CircuitPython, or update current localizations, using [Weblate](#).

If this is your first time contributing, or you'd like to see our recommended contribution workflow, we have a guide on [Contributing to CircuitPython with Git and Github](#). You can also find us in the [#circuitpython](#) channel on the [Adafruit Discord](#).

Have an idea for a new driver or library? [File an issue on the CircuitPython repo!](#)

CircuitPython itself is written in C. However, all of the Adafruit CircuitPython libraries are written in Python. If you're interested in contributing to CircuitPython on the Python side of things, check out [circuitpython.org/contributing](https://circuitpython.org/contributing) (). You'll find information pertaining to every Adafruit CircuitPython library GitHub repository, giving you the opportunity to join the community by finding a contributing option that works for you.

Note the date on the page next to Current Status for:

# Current Status for Tue, Nov 02, 2021

---

If you submit any contributions to the libraries, and do not see them reflected on the Contributing page, it could be that the job that checks for new updates hasn't yet run for today. Simply check back tomorrow!

Now, a look at the different options.

## Pull Requests

The first tab you'll find is a list of open pull requests.

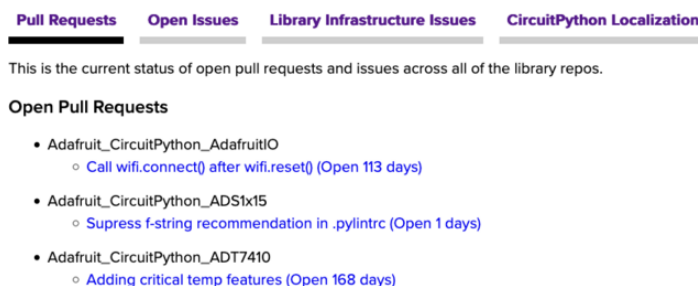

**Pull Requests**   **Open Issues**   **Library Infrastructure Issues**   **CircuitPython Localization**

This is the current status of open pull requests and issues across all of the library repos.

**Open Pull Requests**

- [Adafruit\\_CircuitPython\\_AdafruitIO](#)
  - [Call `wifi.connect\(\)` after `wifi.reset\(\)`](#) (Open 113 days)
- [Adafruit\\_CircuitPython\\_ADS1x15](#)
  - [Supress f-string recommendation in `.pylintrc`](#) (Open 1 days)
- [Adafruit\\_CircuitPython\\_ADT7410](#)
  - [Adding critical temp features](#) (Open 168 days)

GitHub pull requests, or PRs, are opened when folks have added something to an Adafruit CircuitPython library GitHub repo, and are asking for Adafruit to add, or merge, their changes into the main library code. For PRs to be merged, they must first be reviewed. Reviewing is a great way to contribute! Take a look at the list of open pull requests, and pick one that interests you. If you have the hardware, you can test code changes. If you don't, you can still check the code updates for syntax. In the case of documentation updates, you can verify the information, or check it for spelling and grammar. Once you've checked out the update, you can leave a comment letting us know that you took a look. Once you've done that for a while, and you're more comfortable with it, you can consider joining the CircuitPythonLibrarians review team. The more reviewers we have, the more authors we can support. Reviewing is a crucial part of an open source ecosystem, CircuitPython included.

## Open Issues

The second tab you'll find is a list of open issues.

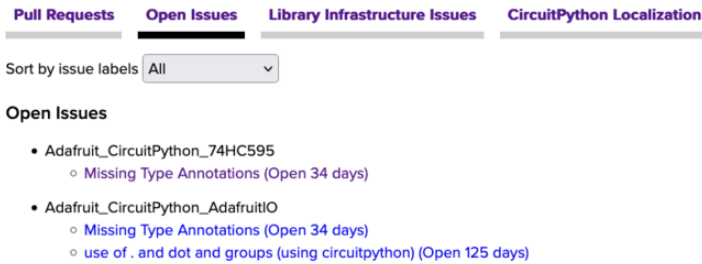

GitHub issues are filed for a number of reasons, including when there is a bug in the library or example code, or when someone wants to make a feature request. Issues are a great way to find an opportunity to contribute directly to the libraries by updating code or documentation. If you're interested in contributing code or documentation, take a look at the open issues and find one that interests you.

If you're not sure where to start, you can search the issues by label. Labels are applied to issues to make the goal easier to identify at a first glance, or to indicate the difficulty level of the issue. Click on the dropdown next to "Sort by issue labels" to see the list of available labels, and click on one to choose it.

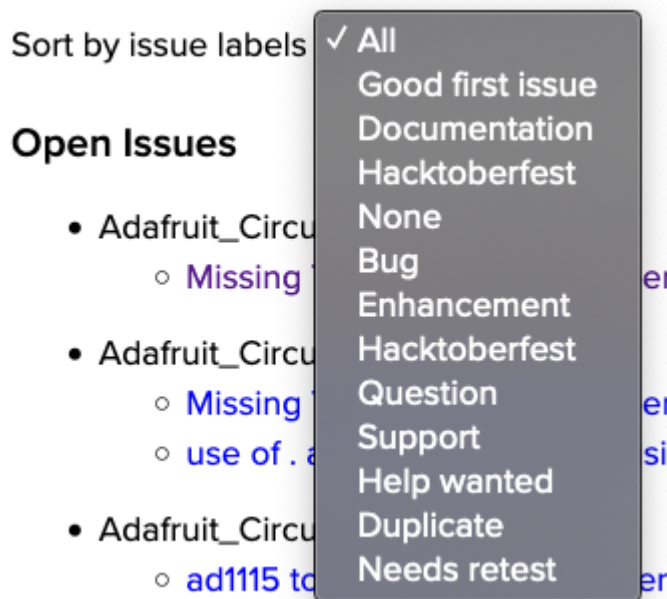

If you're new to everything, new to contributing to open source, or new to contributing to the CircuitPython project, you can choose "Good first issue". Issues with that label are well defined, with a finite scope, and are intended to be easy for someone new to figure out.

If you're looking for something a little more complicated, consider "Bug" or "Enhancement". The Bug label is applied to issues that pertain to problems or failures found in the library. The Enhancement label is applied to feature requests.

Don't let the process intimidate you. If you're new to Git and GitHub, there is [a guide](#) () to walk you through the entire process. As well, there are always folks available on [Discord](#) () to answer questions.

## Library Infrastructure Issues

The third tab you'll find is a list of library infrastructure issues.

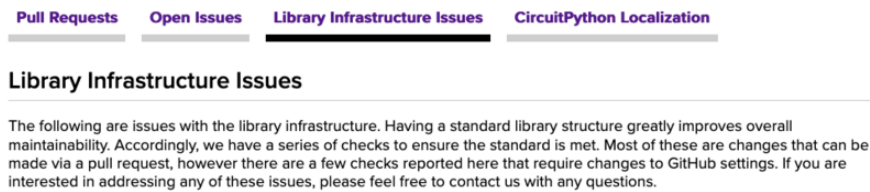

This section is generated by a script that runs checks on the libraries, and then reports back where there may be issues. It is made up of a list of subsections each containing links to the repositories that are experiencing that particular issue. This page is available mostly for internal use, but you may find some opportunities to contribute on this page. If there's an issue listed that sounds like something you could help with, mention it on Discord, or file an issue on GitHub indicating you're working to resolve that issue. Others can reply either way to let you know what the scope of it might be, and help you resolve it if necessary.

## CircuitPython Localization

The fourth tab you'll find is the CircuitPython Localization tab.

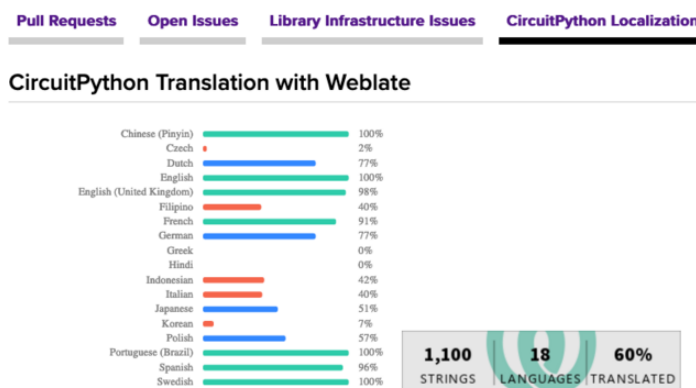

If you speak another language, you can help translate CircuitPython! The translations apply to informational and error messages that are within the CircuitPython core. It means that folks who do not speak English have the opportunity to have these messages shown to them in their own language when using CircuitPython. This is

incredibly important to provide the best experience possible for all users. CircuitPython uses Weblate to translate, which makes it much simpler to contribute translations. You will still need to know some CircuitPython-specific practices and a few basics about coding strings, but as with any CircuitPython contributions, folks are there to help.

Regardless of your skill level, or how you want to contribute to the CircuitPython project, there is an opportunity available. The [Contributing page \(\)](#) is an excellent place to start!

## Adafruit GitHub

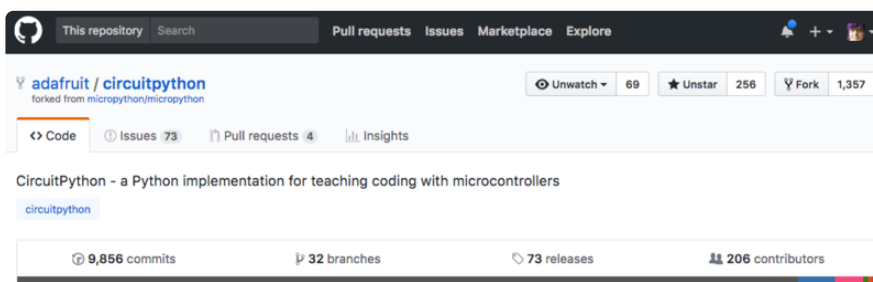

Whether you're just beginning or are life-long programmer who would like to contribute, there are ways for everyone to be a part of the CircuitPython project. The CircuitPython core is written in C. The libraries are written in Python. GitHub is the best source of ways to contribute to the [CircuitPython core \(\)](#), and the [CircuitPython libraries \(\)](#). If you need an account, visit [https://github.com/ \(\)](https://github.com/) and sign up.

If you're new to GitHub or programming in general, there are great opportunities for you. For the CircuitPython core, head over to the CircuitPython repository on GitHub, click on "[Issues \(\)](#)", and you'll find a list that includes issues labeled "[good first issue \(\)](#)". For the libraries, head over to the [Contributing page Issues list \(\)](#), and use the drop down menu to search for "[good first issue \(\)](#)". These issues are things that have been identified as something that someone with any level of experience can help with. These issues include options like updating documentation, providing feedback, and fixing simple bugs. If you need help getting started with GitHub, there is an excellent guide on [Contributing to CircuitPython with Git and GitHub \(\)](#).

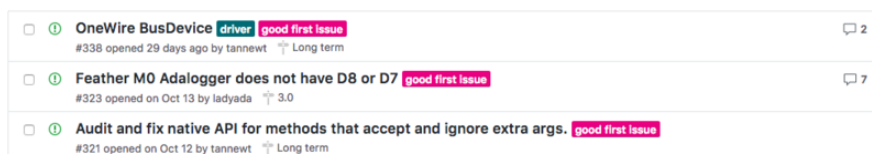

Already experienced and looking for a challenge? Checkout the rest of either issues list and you'll find plenty of ways to contribute. You'll find all sorts of things, from new

driver requests, to library bugs, to core module updates. There's plenty of opportunities for everyone at any level!

When working with or using CircuitPython or the CircuitPython libraries, you may find problems. If you find a bug, that's great! The team loves bugs! Posting a detailed issue to GitHub is an invaluable way to contribute to improving CircuitPython. For CircuitPython itself, file an issue [here](#) (). For the libraries, file an issue on the specific library repository on GitHub. Be sure to include the steps to replicate the issue as well as any other information you think is relevant. The more detail, the better!

Testing new software is easy and incredibly helpful. Simply load the newest version of CircuitPython or a library onto your CircuitPython hardware, and use it. Let us know about any problems you find by posting a new issue to GitHub. Software testing on both stable and unstable releases is a very important part of contributing CircuitPython. The developers can't possibly find all the problems themselves! They need your help to make CircuitPython even better.

On GitHub, you can submit feature requests, provide feedback, report problems and much more. If you have questions, remember that Discord and the Forums are both there for help!

## Adafruit Forums

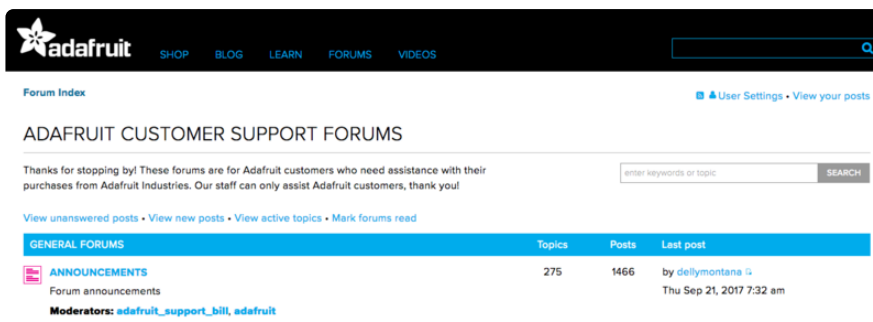

The screenshot shows the Adafruit Forums website. At the top, there is a navigation bar with the Adafruit logo and links for SHOP, BLOG, LEARN, FORUMS, and VIDEOS. Below the navigation bar, the page title is "ADAFRUIT CUSTOMER SUPPORT FORUMS". There is a search bar and a "SEARCH" button. Below the search bar, there are links for "View unanswered posts", "View new posts", "View active topics", and "Mark forums read". A table lists forum categories with columns for "Topics", "Posts", and "Last post". The "ANNOUNCEMENTS" category is highlighted, showing 275 topics and 1466 posts, with the last post by "dellymontana" on "Thu Sep 21, 2017 7:32 am". Moderators are listed as "adafruit\_support\_bill" and "adafruit".

GENERAL FORUMS	Topics	Posts	Last post
 ANNOUNCEMENTS Forum announcements	275	1466	by dellymontana Thu Sep 21, 2017 7:32 am

The [Adafruit Forums](#) () are the perfect place for support. Adafruit has wonderful paid support folks to answer any questions you may have. Whether your hardware is giving you issues or your code doesn't seem to be working, the forums are always there for you to ask. You need an Adafruit account to post to the forums. You can use the same account you use to order from Adafruit.

While Discord may provide you with quicker responses than the forums, the forums are a more reliable source of information. If you want to be certain you're getting an Adafruit-supported answer, the forums are the best place to be.

There are forum categories that cover all kinds of topics, including everything Adafruit. The [Adafruit CircuitPython \(\)](#) category under "Supported Products & Projects" is the best place to post your CircuitPython questions.

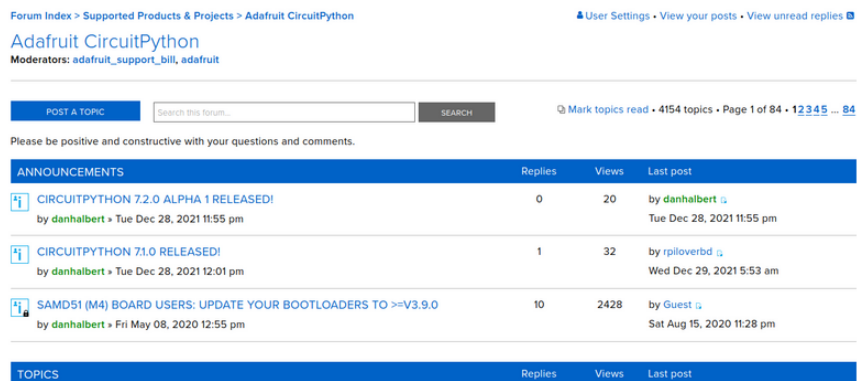

Be sure to include the steps you took to get to where you are. If it involves wiring, post a picture! If your code is giving you trouble, include your code in your post! These are great ways to make sure that there's enough information to help you with your issue.

You might think you're just getting started, but you definitely know something that someone else doesn't. The great thing about the forums is that you can help others too! Everyone is welcome and encouraged to provide constructive feedback to any of the posted questions. This is an excellent way to contribute to the community and share your knowledge!

## Read the Docs

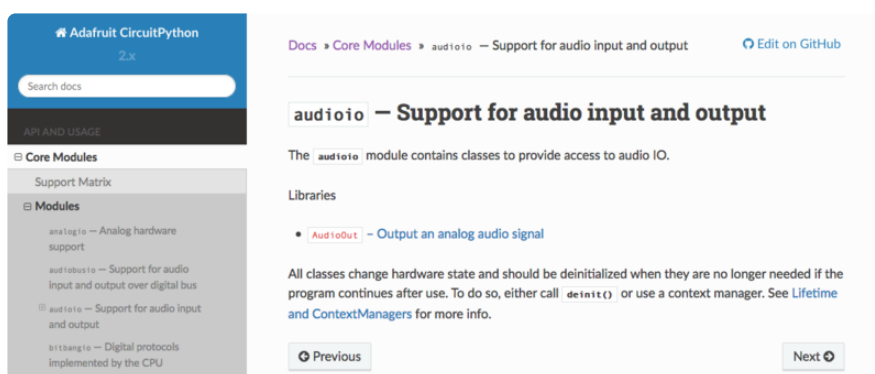

[Read the Docs \(\)](#) is an excellent resource for a more detailed look at the CircuitPython core and the CircuitPython libraries. This is where you'll find things like API documentation and example code. For an in depth look at viewing and understanding Read the Docs, check out the [CircuitPython Documentation \(\)](#) page!



Here is blinky:

```
import time
import digitalio
import board

led = digitalio.DigitalInOut(board.LED)
led.direction = digitalio.Direction.OUTPUT
while True:
    led.value = True
    time.sleep(0.1)
    led.value = False
    time.sleep(0.1)
```

---

## Install CircuitPython

[CircuitPython](#) () is a derivative of [MicroPython](#) () designed to simplify experimentation and education on low-cost microcontrollers. It makes it easier than ever to get prototyping by requiring no upfront desktop software downloads. Simply copy and edit files on the CIRCUITPY drive to iterate.

## Set Up CircuitPython

Follow the steps to get CircuitPython installed on your Metro ESP32-S2.

Download the latest CircuitPython  
for your board from  
[circuitpython.org](https://circuitpython.org)

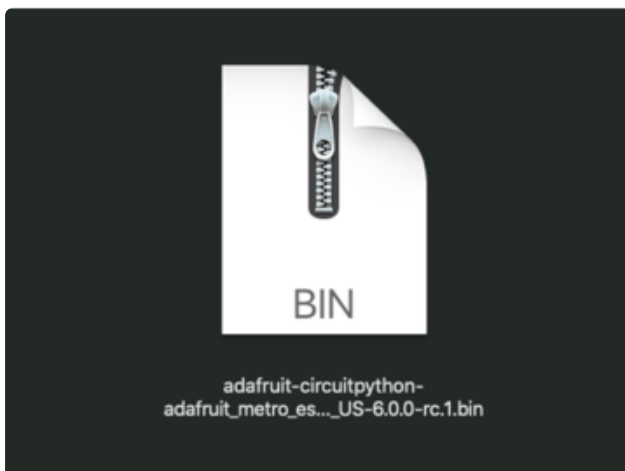

Click the link above and download the latest .BIN file.

Download and save it to your desktop (or wherever is handy).

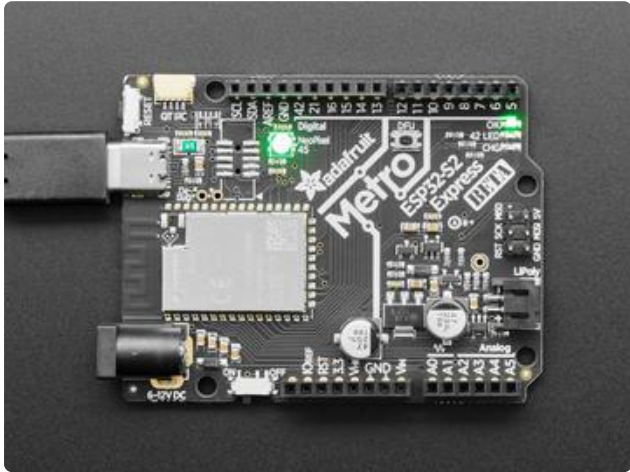

Plug your Metro ESP32-S2 into your computer using a known-good USB cable.

A lot of people end up using charge-only USB cables and it is very frustrating! So make sure you have a USB cable you know is good for data sync.

Follow the 6 steps listed in the [Enter the ROM Bootloader section of the ROM Bootloader page \(\)](#) to enter the bootloader.

Follow the initial steps found in the [Run esptool and check connection section of the ROM Bootloader page \(\)](#) to verify your environment is set up, your board is successfully connected, and which port it's using.

In the final command to write a binary file to the board, replace the port with your port, and replace "firmware.bin" with the the file you downloaded above.

The output should look something like the output in the image.

```
0067 kattni@robocore:esptool $ python ./esptool.py --port /dev/cu.usbmodem01 --after-no-reset
write_flash 0x0 -/adafruit-circuitpython-adafruit_metro_esp32s2-an_05-20201103-5a07925.bin
esptool.py v3.0-dev
Serial port /dev/cu.usbmodem01
Connecting...
Detecting chip type... ESP32-S2
Chip is ESP32-S2
Features: WiFi, ADC and temperature sensor calibration in BLK2 of efuse
Crystal is 40Mhz
MAC: Tc:df:a1:90:4a:a2
Uploading stub...
Running stub...
Stub running...
Configuring flash size...
Compressed 1305184 bytes to 844014...
Wrote 1305184 bytes (844014 compressed) at 0x00000000 in 11.9 seconds (effective 878.2 kbit/s)...
Hash of data verified.
Leaving...
Staying in bootloader.
```

Press reset to exit the bootloader.

Your CIRCUITPY drive should appear!

You're all set!

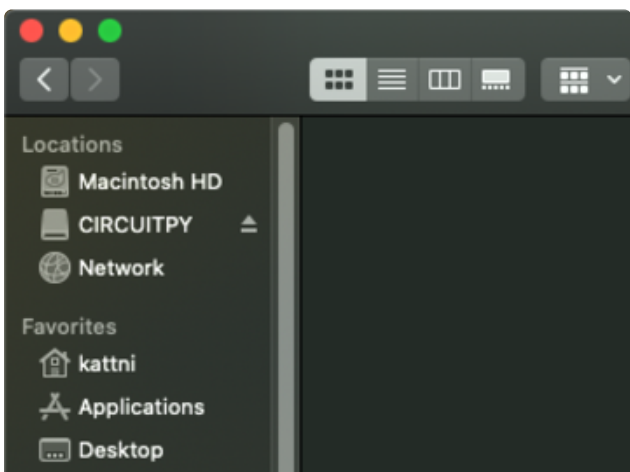

---

# CircuitPython Pin Names

CircuitPython for the Metro ESP32-S2 uses different pin names than you may be used to. Many CircuitPython boards use the D prefix for digital pin names, such as D1 or D12. The pin names for the Metro ESP32-S2 use the IO prefix, such as IO1 or IO12.

The pin numbers on the Metro ESP32-S2 match the ESP32-S2 'low level chip pin numbers' that ESP32 users are most familiar with. The pins are not numbered like other typical Metro-shaped boards, so where you may expect pin 0 to be, its actually IO5.

We're not yet using D prefix names to avoid the confusion of having D-prefix names not match the IO pins.

The following pins have both the standard CircuitPython pin name and the IOx pin name available:

- Analog pins A0-A5
- Default I2C port SCL & SDA
- Default SPI port SCK, MISO, MOSI
- Default hardware Serial port RX, TX
- LED (red LED)
- NEOPIXEL (built in RGB LED)

## Pin Name Diagram

The following diagram shows the standard CircuitPython pin names, the IO pin names, the singleton names and the debug/DFU pins.

## CircuitPython Pin Names

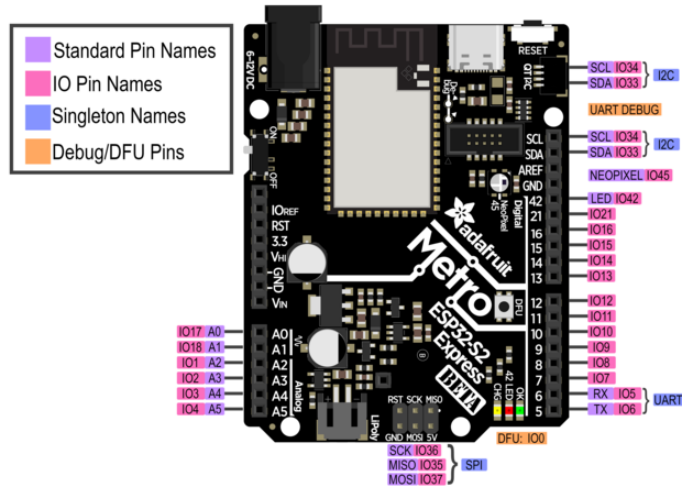

## CircuitPython Internet Test

One of the great things about the ESP32 is the built-in WiFi capabilities. This page covers the basics of getting connected using CircuitPython.

The first thing you need to do is update your code.py to the following. Click the Download Project Bundle button below to download the necessary libraries and the code.py file in a zip file. Extract the contents of the zip file, and copy the entire lib folder and the code.py file to your CIRCUITPY drive.

```
# SPDX-FileCopyrightText: 2020 Brent Rubell for Adafruit Industries
#
# SPDX-License-Identifier: MIT

import ipaddress
import ssl
import wifi
import socketpool
import adafruit_requests

# URLs to fetch from
TEXT_URL = "http://wifitest.adafruit.com/testwifi/index.html"
JSON_QUOTES_URL = "https://www.adafruit.com/api/quotes.php"
JSON_STARS_URL = "https://api.github.com/repos/adafruit/circuitpython"

# Get wifi details and more from a secrets.py file
try:
    from secrets import secrets
except ImportError:
    print("WiFi secrets are kept in secrets.py, please add them there!")
    raise

print("ESP32-S2 WebClient Test")

print("My MAC addr:", [hex(i) for i in wifi.radio.mac_address])
```

```

print("Available WiFi networks:")
for network in wifi.radio.start_scanning_networks():
    print("\t%s\t\tRSSI: %d\tChannel: %d" % (str(network.ssid, "utf-8"),
        network.rssi, network.channel))
wifi.radio.stop_scanning_networks()

print("Connecting to %s"%secrets["ssid"])
wifi.radio.connect(secrets["ssid"], secrets["password"])
print("Connected to %s!"%secrets["ssid"])
print("My IP address is", wifi.radio.ipv4_address)

ipv4 = ipaddress.ip_address("8.8.4.4")
print("Ping google.com: %f ms" % (wifi.radio.ping(ipv4)*1000))

pool = socketpool.SocketPool(wifi.radio)
requests = adafruit_requests.Session(pool, ssl.create_default_context())

print("Fetching text from", TEXT_URL)
response = requests.get(TEXT_URL)
print("-" * 40)
print(response.text)
print("-" * 40)

print("Fetching json from", JSON_QUOTES_URL)
response = requests.get(JSON_QUOTES_URL)
print("-" * 40)
print(response.json())
print("-" * 40)

print()

print("Fetching and parsing json from", JSON_STARS_URL)
response = requests.get(JSON_STARS_URL)
print("-" * 40)
print("CircuitPython GitHub Stars", response.json()["stargazers_count"])
print("-" * 40)

print("done")

```

Your CIRCUITPY drive should resemble the following.

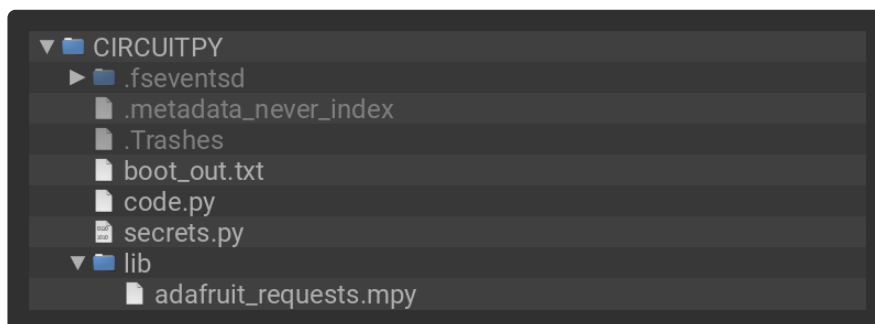

To get connected, the next thing you need to do is update the secrets.py file.

## Secrets File

We expect people to share tons of projects as they build CircuitPython WiFi widgets. What we want to avoid is people accidentally sharing their passwords or secret tokens and API keys. So, we designed all our examples to use a secrets.py file, that is

on your CIRCUITPY drive, to hold secret/private/custom data. That way you can share your main project without worrying about accidentally sharing private stuff.

The initial secrets.py file on your CIRCUITPY drive should look like this:

```
# SPDX-FileCopyrightText: 2020 Adafruit Industries
#
# SPDX-License-Identifier: Unlicense

# This file is where you keep secret settings, passwords, and tokens!
# If you put them in the code you risk committing that info or sharing it

secrets = {
    'ssid' : 'home_wifi_network',
    'password' : 'wifi_password',
    'aio_username' : 'my_adafruit_io_username',
    'aio_key' : 'my_adafruit_io_key',
    'timezone' : "America/New_York", # http://worldtimeapi.org/timezones
}
```

Inside is a Python dictionary named secrets with a line for each entry. Each entry has an entry name (say 'ssid') and then a colon to separate it from the entry key ('home\_wifi\_network') and finally a comma (,).

At a minimum you'll need to adjust the ssid and password for your local WiFi setup so do that now!

As you make projects you may need more tokens and keys, just add them one line at a time. See for example other tokens such as one for accessing GitHub or the Hackaday API. Other non-secret data like your timezone can also go here, just cause its called secrets doesn't mean you can't have general customization data in there!

For the correct time zone string, look at [http://worldtimeapi.org/timezones \(\)](http://worldtimeapi.org/timezones) and remember that if your city is not listed, look for a city in the same time zone, for example Boston, New York, Philadelphia, Washington DC, and Miami are all on the same time as New York.

Of course, don't share your secrets.py - keep that out of GitHub, Discord or other project-sharing sites.

Don't share your secrets.py file, it has your passwords and API keys in it!

If you connect to the serial console, you should see something like the following:

```

1. screen /Users/brentrubell (screen)
Auto-reload is on. Simply save files over USB to run them or enter REPL to disable.
code.py output:
ESP32-S2 WebClient Test
My MAC addr: ['0x7c', '0xdf', '0xa1', '0x0', '0x52', '0xa0']
Avaliable WiFi networks:
  Brunelleschi      RSSI: -84      Channel: 6
  Transit           RSSI: -54      Channel: 1
  Fios-5dLNb        RSSI: -66      Channel: 1
  disconnectededer   RSSI: -86      Channel: 1
  SKJFios-ZV007     RSSI: -83      Channel: 11
  Fios-QIVUQ        RSSI: -83      Channel: 11
  Fios-ZV007        RSSI: -85      Channel: 11
  [REDACTED]         RSSI: -58      Channel: 2
  [REDACTED]         RSSI: -76      Channel: 8
  NETGEAR52         RSSI: -81      Channel: 10
Connecting to Transit
Connected to Transit!
None
My IP address is 192.168.1.182
Ping google.com: 0.065000 ms
Fetching text from http://wifitest.adafruit.com/testwifi/index.html
-----
This is a test of Adafruit WiFi!
If you can read this, its working :)

-----
Fetching json from https://www.adafruit.com/api/quotes.php
-----
[{'text': 'Science, my lad, is made up of mistakes, but they are mistakes which it is u
seful to make, because they lead little by little to the truth', 'author': 'Jules Verne
'}]
-----
Fetching and parsing json from https://api.github.com/repos/adafruit/circuitpython
-----
CircuitPython GitHub Stars 1896
-----
done

```

In order, the example code...

Checks the ESP32's MAC address.

```
print("My MAC addr:", [hex(i) for i in wifi.radio.mac_address])
```

Performs a scan of all access points and prints out the access point's name (SSID), signal strength (RSSI), and channel.

```
print("Avaliable WiFi networks:")
for network in wifi.radio.start_scanning_networks():
    print("\t%s\t\tRSSI: %d\tChannel: %d" % (str(network.ssid, "utf-8"),
        network.rssi, network.channel))
wifi.radio.stop_scanning_networks()
```

Connects to the access point you defined in the secrets.py file, prints out its local IP address, and attempts to ping google.com to check its network connectivity.

```
print("Connecting to %s"%secrets["ssid"])
wifi.radio.connect(secrets["ssid"], secrets["password"])
print(print("Connected to %s!"%secrets["ssid"]))
print("My IP address is", wifi.radio.ipv4_address)

ipv4 = ipaddress.ip_address("8.8.4.4")
print("Ping google.com: %f ms" % wifi.radio.ping(ipv4))
```

The code creates a socketpool using the wifi radio's available sockets. This is performed so we don't need to re-use sockets. Then, it initializes a new instance of the `requests ()` interface - which makes getting data from the internet really really easy.

```
pool = socketpool.SocketPool(wifi.radio)
requests = adafruit_requests.Session(pool, ssl.create_default_context())
```

To read in plain-text from a web URL, call `requests.get` - you may pass in either a http, or a https url for SSL connectivity.

```
print("Fetching text from", TEXT_URL)
response = requests.get(TEXT_URL)
print("-" * 40)
print(response.text)
print("-" * 40)
```

Requests can also display a JSON-formatted response from a web URL using a call to `requests.get`.

```
print("Fetching json from", JSON_QUOTES_URL)
response = requests.get(JSON_QUOTES_URL)
print("-" * 40)
print(response.json())
print("-" * 40)
```

Finally, you can fetch and parse a JSON URL using `requests.get`. This code snippet obtains the `stargazers_count` field from a call to the GitHub API.

```
print("Fetching and parsing json from", JSON_STARS_URL)
response = requests.get(JSON_STARS_URL)
print("-" * 40)
print("CircuitPython GitHub Stars", response.json()["stargazers_count"])
print("-" * 40)
```

OK you now have your ESP32 board set up with a proper secrets.py file and can connect over the Internet. If not, check that your secrets.py file has the right ssid and password and retrace your steps until you get the Internet connectivity working!

---

## Getting The Date & Time

A very common need for projects is to know the current date and time. Especially when you want to deep sleep until an event, or you want to change your display based on what day, time, date, etc. it is



Determining the correct local time is really really hard. There are various time zones, Daylight Savings dates, leap seconds, etc. Trying to get NTP time and then back-calculating what the local time is, is extraordinarily hard on a microcontroller just isn't worth the effort and it will get out of sync as laws change anyways.

For that reason, we have the free adafruit.io time service. Free for anyone with a free adafruit.io account. You do need an account because we have to keep accidentally mis-programmed-board from overwhelming adafruit.io and lock them out temporarily. Again, it's free!

There are other services like WorldTimeAPI, but we don't use those for our guides because they are nice people and we don't want to accidentally overload their site. Also, there's a chance it may eventually go down or also require an account.

## Step 1) Make an Adafruit account

It's free! Visit <https://accounts.adafruit.com/> () to register and make an account if you do not already have one

## Step 2) Sign into Adafruit IO

Head over to [io.adafruit.com](https://io.adafruit.com/) () and click Sign In to log into IO using your Adafruit account. It's free and fast to join.

## Step 3) Get your Adafruit IO Key

Click on My Key in the top bar

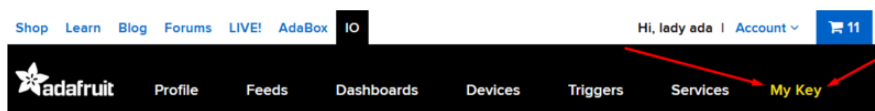

You will get a popup with your Username and Key (In this screenshot, we've covered it with red blocks)

## YOUR ADAFRUIT IO KEY ✕

Your Adafruit IO Key should be kept in a safe place and treated with the same care as your Adafruit username and password. People who have access to your Adafruit IO Key can view all of your data, create new feeds for your account, and manipulate your active feeds.

If you need to regenerate a new Adafruit IO Key, all of your existing programs and scripts will need to be manually changed to the new key.

Username

Active Key

REGENERATE KEY

[Hide Code Samples](#)

Go to your secrets.py file on your CIRCUITPY drive and add three lines for `aio_username`, `aio_key` and `timezone` so you get something like the following:

```
# This file is where you keep secret settings, passwords, and tokens!  
# If you put them in the code you risk committing that info or sharing it  
  
secrets = {  
    'ssid' : 'home_wifi_network',  
    'password' : 'wifi_password',  
    'aio_username' : 'my_adafruit_io_username',  
    'aio_key' : 'my_adafruit_io_key',  
    'timezone' : "America/New_York", # http://worldtimeapi.org/timezones  
}
```

The timezone is optional, if you don't have that entry, adafruit.io will guess your timezone based on geographic IP address lookup. You can visit <http://worldtimeapi.org/timezones> () to see all the time zones available (even though we do not use Worldtime for time-keeping, we do use the same time zone table).

## Step 4) Upload Test Python Code

This code is like the Internet Test code from before, but this time it will connect to adafruit.io and get the local time

```
import ipaddress  
import ssl  
import wifi  
import socketpool  
import adafruit_requests  
import secrets  
  
TEXT_URL = "http://wifitest.adafruit.com/testwifi/index.html"  
JSON_QUOTES_URL = "https://www.adafruit.com/api/quotes.php"  
JSON_STARS_URL = "https://api.github.com/repos/adafruit/circuitpython"  
  
# Get wifi details and more from a secrets.py file  
try:  
    from secrets import secrets
```

```

except ImportError:
    print("WiFi secrets are kept in secrets.py, please add them there!")
    raise

# Get our username, key and desired timezone
aio_username = secrets["aio_username"]
aio_key = secrets["aio_key"]
location = secrets.get("timezone", None)
TIME_URL = "https://io.adafruit.com/api/v2/%s/integrations/time/strftime?x-aio-
key=%s&tz=%s" % (aio_username, aio_key, location)
TIME_URL += "&fmt=%25Y-%25m-%25d+%25H%3A%25M%3A%25S.%25L+%25j+%25u+%25z+%25Z"

print("ESP32-S2 Adafruit IO Time test")

print("My MAC addr:", [hex(i) for i in wifi.radio.mac_address])

print("Available WiFi networks:")
for network in wifi.radio.start_scanning_networks():
    print("\t%s\t\tRSSI: %d\tChannel: %d" % (str(network.ssid, "utf-8"),
        network.rssi, network.channel))
wifi.radio.stop_scanning_networks()

print("Connecting to %s"%secrets["ssid"])
wifi.radio.connect(secrets["ssid"], secrets["password"])
print("Connected to %s!"%secrets["ssid"])
print("My IP address is", wifi.radio.ipv4_address)

ipv4 = ipaddress.ip_address("8.8.4.4")
print("Ping google.com: %f ms" % wifi.radio.ping(ipv4))

pool = socketpool.SocketPool(wifi.radio)
requests = adafruit_requests.Session(pool, ssl.create_default_context())

print("Fetching text from", TIME_URL)
response = requests.get(TIME_URL)
print("-" * 40)
print(response.text)
print("-" * 40)

```

After running this, you will see something like the below text. We have blocked out the part with the secret username and key data!

```

Connecting to adafruit
Connected to adafruit!
My IP address is 10.0.1.148
Ping google.com: 0.008000 ms
Fetching text from https://io.adafruit.com/api/v2/[REDACTED]/integrations/time/strftime?x-aio-
key=[REDACTED]&fmt=%25Y-%25m-%25d+%25H%3A%25M%3A%25S.%25L+%25j+%25u+%25z+%25Z
-----
2020-12-05 18:51:32.145 340 6 -0500 ES
-----

```

Note at the end you will get the date, time, and your timezone! If so, you have correctly configured your secrets.py and can continue to the next steps!

---

# CircuitPython Essentials



You've been introduced to CircuitPython, and worked through getting everything set up. What's next? CircuitPython Essentials!

There are a number of core modules built into CircuitPython, which can be used along side the many CircuitPython libraries available. The following pages demonstrate some of these modules. Each page presents a different concept including a code example with an explanation. All of the examples are designed to work with your microcontroller board.

Time to get started learning the CircuitPython essentials!

---

## Blink

In learning any programming language, you often begin with some sort of **Hello, World!** program. In CircuitPython, Hello, World! is blinking an LED. Blink is one of the simplest programs in CircuitPython. It involves three built-in modules, two lines of set up, and a short loop. Despite its simplicity, it shows you many of the basic concepts needed for most CircuitPython programs, and provides a solid basis for more complex projects. Time to get blinky!

## LED Location

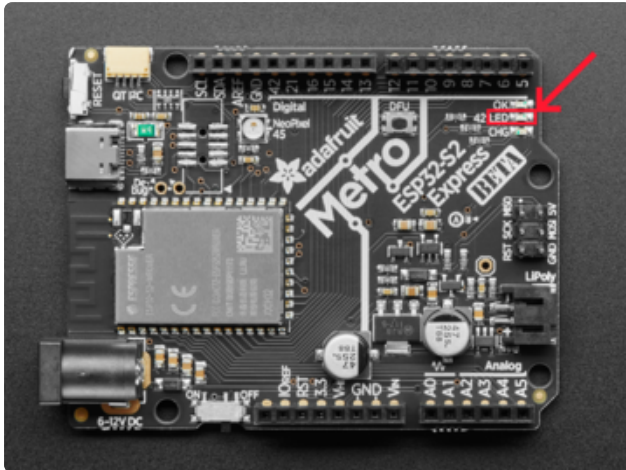

The Built-in Red LED is located in the upper right of the board below the OK LED and has the number 42 to the left of it.

## Blinking an LED

In the example below, click the Download Project Bundle button below to download the necessary libraries and the code.py file in a zip file. Extract the contents of the zip file, open the directory CircuitPython\_Templates/blink/ and then click on the directory that matches the version of CircuitPython you're using and copy the contents of that directory to your CIRCUITPY drive.

Your CIRCUITPY drive should now look similar to the following image:

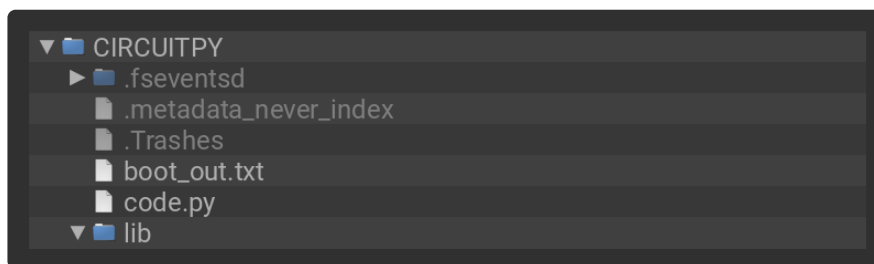

```
# SPDX-FileCopyrightText: 2021 Kattni Rembor for Adafruit Industries
# SPDX-License-Identifier: MIT
"""CircuitPython Blink Example - the CircuitPython 'Hello, World!'"""
import time
import board
import digitalio

led = digitalio.DigitalInOut(board.LED)
led.direction = digitalio.Direction.OUTPUT

while True:
    led.value = True
    time.sleep(0.5)
    led.value = False
    time.sleep(0.5)
```

The built-in LED begins blinking!

Note that the code is a little less "Pythonic" than it could be. It could also be written as `led.value = not led.value` with a single `time.sleep(0.5)`. That way is more difficult to understand if you're new to programming, so the example is a bit longer than it needed to be to make it easier to read.

It's important to understand what is going on in this program.

First you `import` three modules: `time`, `board` and `digitalio`. This makes these modules available for use in your code. All three are built-in to CircuitPython, so you don't need to download anything to get started.

Next, you set up the LED. To interact with hardware in CircuitPython, your code must let the board know where to look for the hardware and what to do with it. So, you create a `digitalio.DigitalInOut()` object, provide it the LED pin using the `board` module, and save it to the variable `led`. Then, you tell the pin to act as an `OUTPUT`.

Finally, you create a `while True:` loop. This means all the code inside the loop will repeat indefinitely. Inside the loop, you set `led.value = True` which powers on the LED. Then, you use `time.sleep(0.5)` to tell the code to wait half a second before moving on to the next line. The next line sets `led.value = False` which turns the LED off. Then you use another `time.sleep(0.5)` to wait half a second before starting the loop over again.

With only a small update, you can control the blink speed. The blink speed is controlled by the amount of time you tell the code to wait before moving on using `time.sleep()`. The example uses `0.5`, which is one half of one second. Try increasing or decreasing these values to see how the blinking changes.

That's all there is to blinking an LED using CircuitPython!

---

## Arduino IDE Setup

The ESP32-S2/S3 bootloader does not have USB serial support for Windows 7 or 8. (See <https://github.com/espressif/arduino-esp32/issues/5994>) please update to version 10 which is supported by espressif! Alternatively you can try this community-crafted Windows 7 driver (<https://github.com/kutukvpavel/Esp32-Win7-VCP-drivers>)

The first thing you will need to do is to download the latest release of the Arduino IDE. You will need to be using version 1.8 or higher for this guide

## Arduino IDE Download

The ESP32-S2/S3 Arduino board support package is currently part of the 2.0.0 or later release. To use the ESP32-S2/S3 with Arduino, you'll need to follow the steps below for your operating system. You can also [check out the Espressif Arduino repository for the most up to date details on how to install it \(\)](#).

After you have downloaded and installed the latest version of Arduino IDE, you will need to start the IDE and navigate to the Preferences menu. You can access it from the File menu in Windows or Linux, or the Arduino menu on OS X.

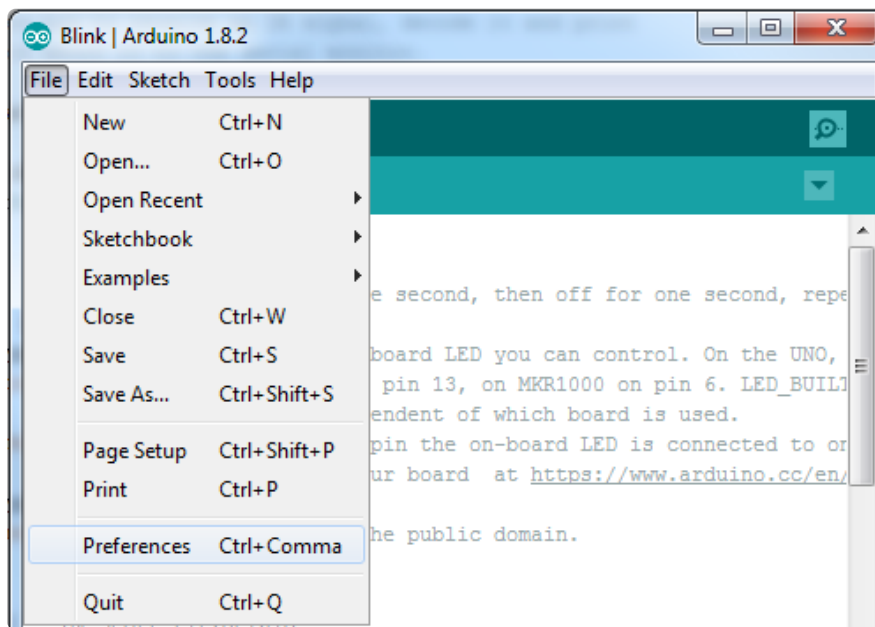

A dialog will pop up just like the one shown below.

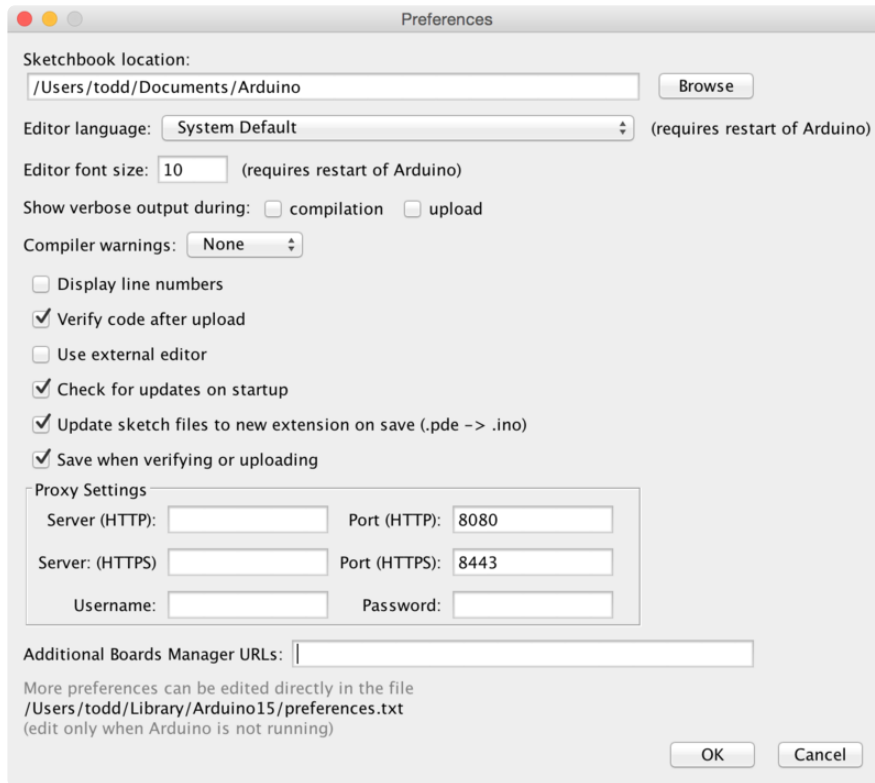

We will be adding a URL to the new Additional Boards Manager URLs option. The list of URLs is comma separated, and you will only have to add each URL once. New Adafruit boards and updates to existing boards will automatically be picked up by the Board Manager each time it is opened. The URLs point to index files that the Board Manager uses to build the list of available & installed boards.

To find the most up to date list of URLs you can add, you can visit the list of [third party board URLs on the Arduino IDE wiki](#) (). We will only need to add one URL to the IDE in this example, but you can add multiple URLs by separating them with commas. Copy and paste the link below into the Additional Boards Manager URLs option in the Arduino IDE preferences.

[https://raw.githubusercontent.com/espressif/arduino-esp32/gh-pages/package\\_esp32\\_dev\\_index.json](https://raw.githubusercontent.com/espressif/arduino-esp32/gh-pages/package_esp32_dev_index.json)

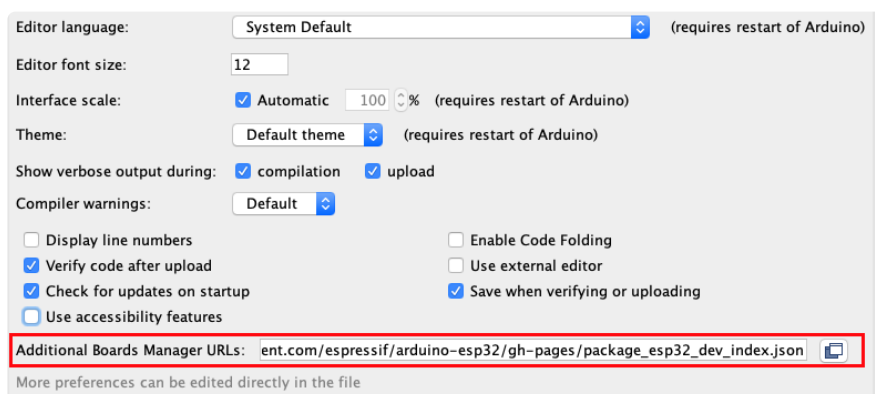



If you have multiple boards you want to support, say ESP8266 and Adafruit, have both URLs in the text box separated by a comma (,)

Once done click OK to save the new preference settings.

The next step is to actually install the Board Support Package (BSP). Go to the Tools → Board → Board Manager submenu. A dialog should come up with various BSPs. Search for esp32.

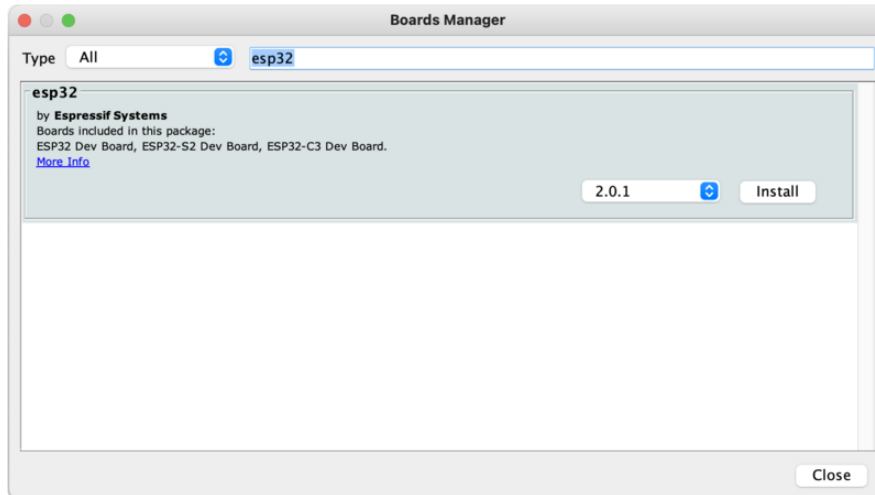

Click the Install button and wait for it to finish. Once it is finished, you can close the dialog.

In the Tools → Board submenu you should see ESP32 Arduino and in that dropdown it should contain the ESP32 boards along with all the latest ESP32-S2/S3 boards.

Look for the board called Adafruit Metro ESP32-S2.

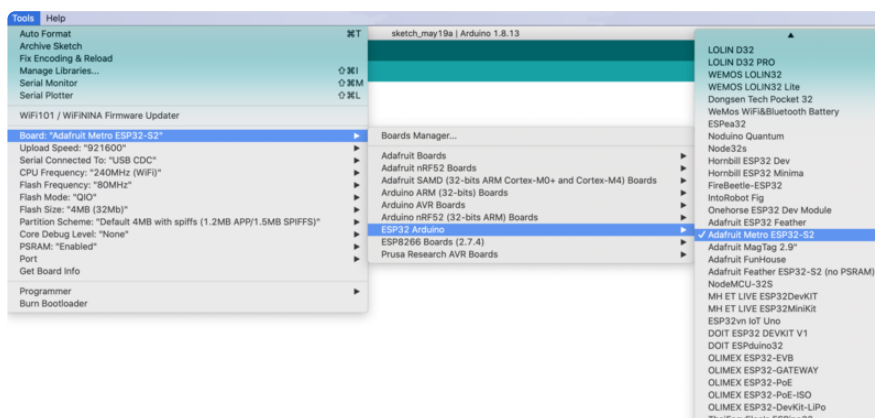

---

# Using with Arduino IDE

## Blink

Now you can upload your first blink sketch!

Plug in the ESP32-S2/S3 board and wait for it to be recognized by the OS (just takes a few seconds).

## Select ESP32-S2/S3 Board in Arduino IDE

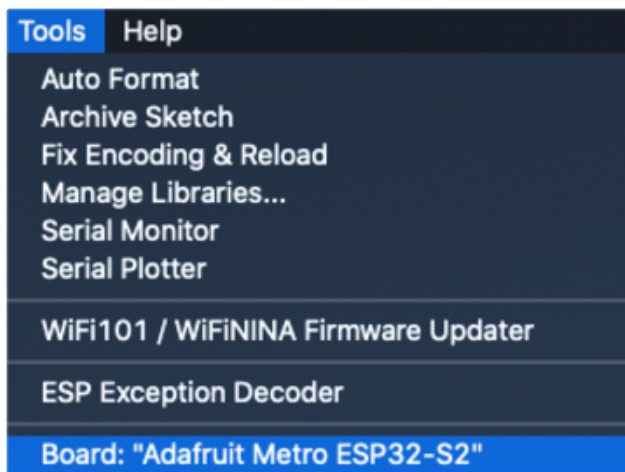

On the Arduino IDE, click:

Tools -> Board -> ESP32 Arduino -> Your Adafruit ESP32-S2/S3 board

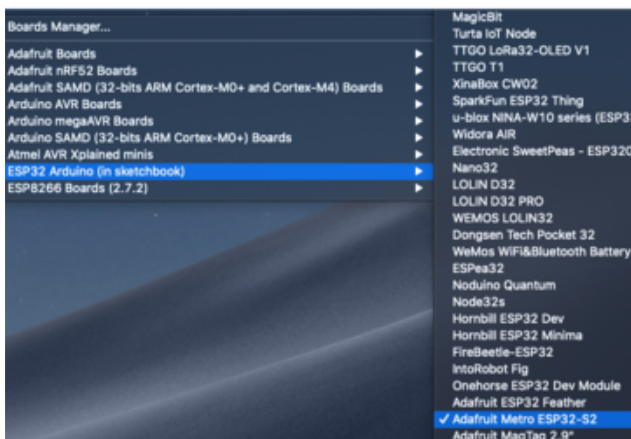

The screenshot shows Metro S2 but you may have a different board. Make sure the name matches the exact product you purchased. If you don't see your board, make sure you have the latest version of the ESP32 board support package

## Launch ESP32-S2/S3 ROM Bootloader

ESP32-S2/S3 support in Arduino uses native USB which can crash. If you ever DON'T see a serial/COM port, you can always manually enter bootloading mode. This bootloader is in ROM, it is 'un-brickable' so you can always use this

technique to get into the bootloader. However, after uploading your Arduino code you MUST press reset to start the sketch

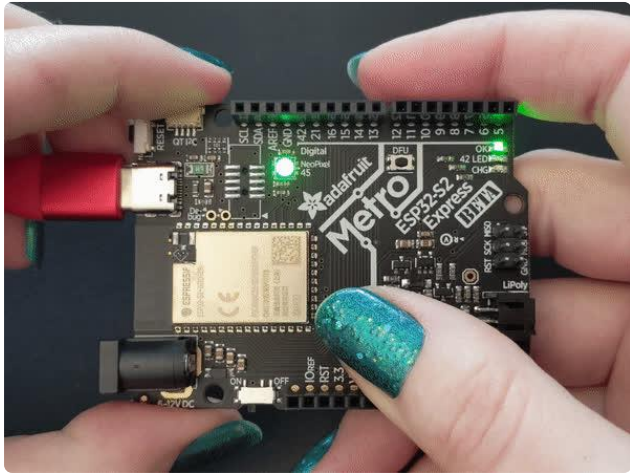

Before we upload a sketch, place your ESP32-S2/S3 board into ROM bootloader mode ().

Look for the Reset button and a second DFU / BOOT0 button

HOLD down the DFU/Boot0 button while you click Reset. Then release DFU/Boot0 button

The GIF shows a Metro S2 but your board may look different. It will still have BOOT and Reset buttons somewhere

It should appear under Tools -> Port as ESP32-S2/S3 Dev Module.

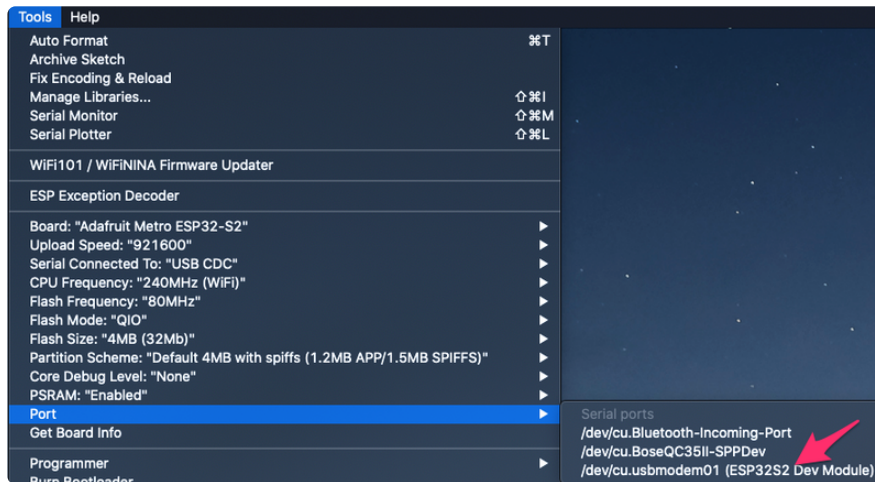

Do not select any other port than the one that is called "ESP32S2 Dev Module" or "ESP32S3 Dev Module"

## Load Blink Sketch

Now open up this Blink example in a new sketch window

```
// the setup function runs once when you press reset or power the board
void setup() {
  // initialize built in LED pin as an output.
  pinMode(LED_BUILTIN, OUTPUT);
}
```

```

// initialize USB serial converter so we have a port created
Serial.begin();
}

// the loop function runs over and over again forever
void loop() {
  digitalWrite(LED_BUILTIN, HIGH); // turn the LED on (HIGH is the voltage level)
  delay(1000); // wait for a second
  digitalWrite(LED_BUILTIN, LOW); // turn the LED off by making the voltage LOW
  delay(1000); // wait for a second
}

```

Note that we use LED\_BUILTIN not pin 13 for the LED pin. That's because we don't always use pin 13 for the LED on boards. For example, on the Metro ESP32-S2 the LED is on pin 42!

And click upload! After uploading, you may see something like this:

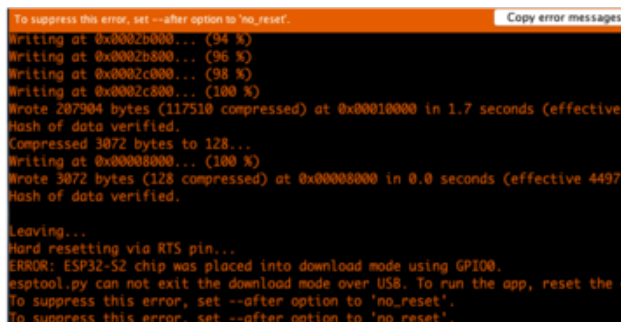

And click upload! After uploading, you may see something like this, warning you that we could not get out of reset.

This is normal! Press the RESET button on your board to launch the sketch

That's it, you will be able to see the red LED blink. You will also see a new serial port created.

You may call `Serial.begin();` in your sketch to create the serial port so don't forget it, it is not required for other Arduinos or previous ESP boards!

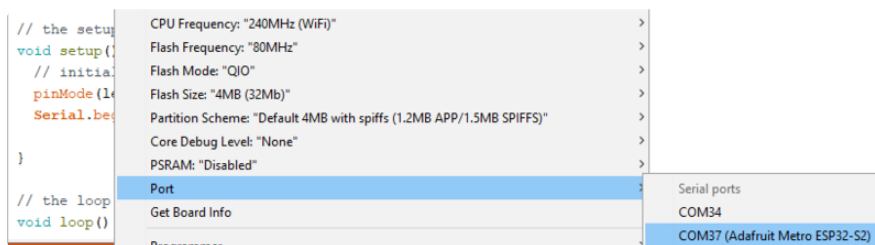

You can now select the new serial port name which will be different than the bootloader serial port. Arduino IDE will try to use auto-reset to automatically put the board into bootloader mode when you ask it to upload new code

If you ever DON'T see a serial port, or something is not working out with upload you can always manually enter bootloader mode:

- Reset board into ROM bootloader with DFU/BOOT0 + Reset buttons
- Select the ESP32S2/S3 Dev Board ROM bootloader serial port in Tools->Port menu
- Upload sketch
- Click reset button to launch code

---

## WiFi Test

Thankfully if you have ESP32 sketches, they'll 'just work' with variations of ESP32. You can find a wide range of examples in the File->Examples->Examples for Adafruit Metro ESP32-S2 subheading (the name of the board may vary so it could be "Examples for Adafruit Feather ESP32 V2" etc)

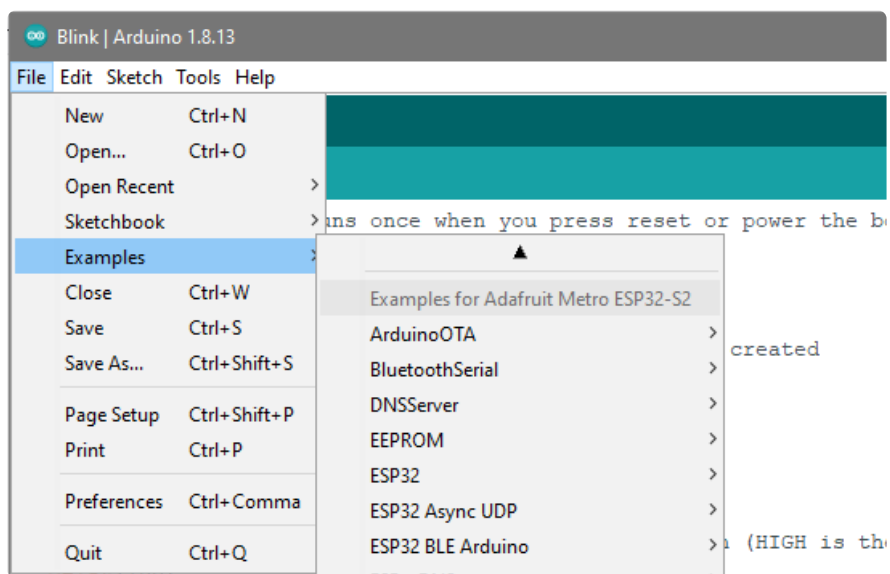

Let's start by scanning the local networks.

Load up the WiFiScan example under Examples->Examples for YOUR BOARDNAME->WiFi->WiFiScan

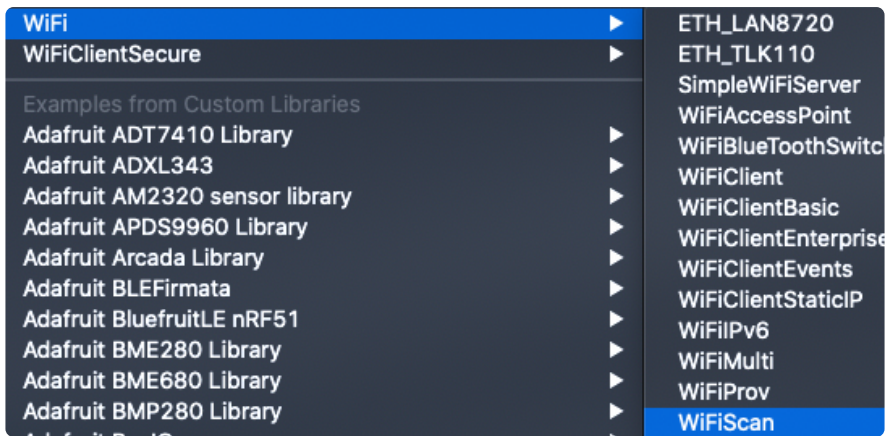

And upload this example to your board. The ESP32 should scan and find WiFi networks around you.

For ESP32, open the serial monitor, to see the scan begin.

For ESP32-S2, -S3 and -C3, don't forget you have to click Reset after uploading through the ROM bootloader. Then select the new USB Serial port created by the ESP32. It will take a few seconds for the board to complete the scan.

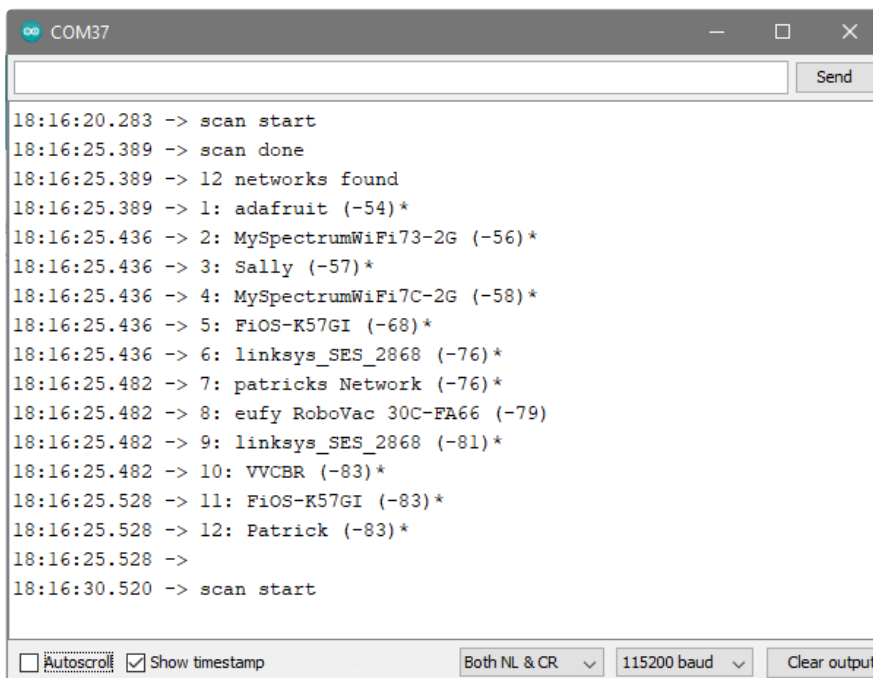

If you can not scan any networks, check your power supply. You need a solid power supply in order for the ESP32 to not brown out. A skinny USB cable or drained battery can cause issues.

# WiFi Connection Test

Now that you can scan networks around you, its time to connect to the Internet!

Copy the example below and paste it into the Arduino IDE:

```
// SPDX-FileCopyrightText: 2020 Brent Rubell for Adafruit Industries
//
// SPDX-License-Identifier: MIT

/*
  Web client

  This sketch connects to a website (wifitest.adafruit.com/testwifi/index.html)
  using the WiFi module.

  This example is written for a network using WPA encryption. For
  WEP or WPA, change the Wifi.begin() call accordingly.

  This example is written for a network using WPA encryption. For
  WEP or WPA, change the Wifi.begin() call accordingly.

  created 13 July 2010
  by dlf (Metodo2 srl)
  modified 31 May 2012
  by Tom Igoe
*/

#include <WiFi.h>

// Enter your WiFi SSID and password
char ssid[] = "YOUR_SSID";           // your network SSID (name)
char pass[] = "YOUR_SSID_PASSWORD"; // your network password (use for WPA, or
use as key for WEP)
int keyIndex = 0;                    // your network key Index number (needed
only for WEP)

int status = WL_IDLE_STATUS;
// if you don't want to use DNS (and reduce your sketch size)
// use the numeric IP instead of the name for the server:
//IPAddress server(74,125,232,128); // numeric IP for Google (no DNS)

char server[] = "wifitest.adafruit.com"; // name address for adafruit test
char path[] = "/testwifi/index.html";

// Initialize the Ethernet client library
// with the IP address and port of the server
// that you want to connect to (port 80 is default for HTTP):
WiFiClient client;

void setup() {
  //Initialize serial and wait for port to open:
  Serial.begin(115200);
  while (!Serial) {
    ; // wait for serial port to connect. Needed for native USB port only
  }

  // attempt to connect to Wifi network:
  Serial.print("Attempting to connect to SSID: ");
  Serial.println(ssid);

  WiFi.begin(ssid, pass);
```

```

while (WiFi.status() != WL_CONNECTED) {
    delay(500);
    Serial.print(".");
}

Serial.println("");
Serial.println("Connected to WiFi");
printWifiStatus();

Serial.println("\nStarting connection to server...");
// if you get a connection, report back via serial:
if (client.connect(server, 80)) {
    Serial.println("connected to server");
    // Make a HTTP request:
    client.print("GET "); client.print(path); client.println(" HTTP/1.1");
    client.print("Host: "); client.println(server);
    client.println("Connection: close");
    client.println();
}
}

void loop() {
    // if there are incoming bytes available
    // from the server, read them and print them:
    while (client.available()) {
        char c = client.read();
        Serial.write(c);
    }

    // if the server's disconnected, stop the client:
    if (!client.connected()) {
        Serial.println();
        Serial.println("disconnecting from server.");
        client.stop();

        // do nothing forevermore:
        while (true) {
            delay(100);
        }
    }
}

void printWifiStatus() {
    // print the SSID of the network you're attached to:
    Serial.print("SSID: ");
    Serial.println(WiFi.SSID());

    // print your board's IP address:
    IPAddress ip = WiFi.localIP();
    Serial.print("IP Address: ");
    Serial.println(ip);

    // print the received signal strength:
    long rssi = WiFi.RSSI();
    Serial.print("signal strength (RSSI):");
    Serial.print(rssi);
    Serial.println(" dBm");
}

```

NOTE: You must change the **SECRET\_SSID** and **SECRET\_PASS** in the example code to your WiFi SSID and password before uploading this to your board.



```

// Enter your WiFi SSID and password
char ssid[] = "YOUR_SSID"; // your network SSID (name)
char pass[] = "YOUR_SSID_PASSWORD"; // your network password (use for WPA, or use as key for WEP)
int keyIndex = 0; // your network key Index number (needed only for WEP)

```

After you've set it correctly, upload and check the serial monitor. You should see the following. If not, go back, check wiring, power and your SSID/password

```

Attempting to connect to SSID: Transit
.....
Connected to WiFi
SSID: Transit
IP Address: 192.168.1.182
signal strength (RSSI):-57 dBm

Starting connection to server...
connected to server
HTTP/1.1 200 OK
Server: nginx/1.10.3 (Ubuntu)
Date: Wed, 11 Nov 2020 20:51:30 GMT
Content-Type: text/html
Content-Length: 70
Last-Modified: Thu, 16 May 2019 18:21:16 GMT
Connection: close
ETag: "5cddaa1c-46"
Accept-Ranges: bytes

This is a test of Adafruit WiFi!
If you can read this, its working :)

disconnecting from server.

```

## Secure Connection Example

Many servers today do not allow non-SSL connectivity. Lucky for you the ESP32 has a great TLS/SSL stack so you can have that all taken care of for you. Here's an example of a using a secure WiFi connection to connect to the Twitter API.

Copy and paste it into the Arduino IDE:

```

// SPDX-FileCopyrightText: 2015 Arturo Guadalupi
// SPDX-FileCopyrightText: 2020 Brent Rubell for Adafruit Industries
//
// SPDX-License-Identifier: MIT

/*
This example creates a client object that connects and transfers
data using always SSL.

```

It is compatible with the methods normally related to plain connections, like `client.connect(host, port)`.

Written by Arturo Guadalupi  
last revision November 2015

```
*/  
  
#include <WiFiClientSecure.h>  
  
// Enter your WiFi SSID and password  
char ssid[] = "YOUR_SSID";           // your network SSID (name)  
char pass[] = "YOUR_SSID_PASSWORD";  // your network password (use for WPA, or  
use as key for WEP)  
int keyIndex = 0;                    // your network key Index number (needed  
only for WEP)  
  
int status = WL_IDLE_STATUS;  
// if you don't want to use DNS (and reduce your sketch size)  
// use the numeric IP instead of the name for the server:  
//IPAddress server(74,125,232,128); // numeric IP for Google (no DNS)  
  
#define SERVER "cdn.syndication.twimg.com"  
#define PATH   "/widgets/followbutton/info.json?screen_names=adafruit"  
  
// Initialize the SSL client library  
// with the IP address and port of the server  
// that you want to connect to (port 443 is default for HTTPS):  
WiFiClientSecure client;  
  
void setup() {  
  //Initialize serial and wait for port to open:  
  Serial.begin(115200);  
  while (!Serial) {  
    ; // wait for serial port to connect. Needed for native USB port only  
  }  
  
  // attempt to connect to Wifi network:  
  Serial.print("Attempting to connect to SSID: ");  
  Serial.println(ssid);  
  
  WiFi.begin(ssid, pass);  
  while (WiFi.status() != WL_CONNECTED) {  
    delay(500);  
    Serial.print(".");  
  }  
  
  Serial.println("");  
  Serial.println("Connected to WiFi");  
  printWifiStatus();  
  
  client.setInsecure(); // don't use a root cert  
  
  Serial.println("\nStarting connection to server...");  
  // if you get a connection, report back via serial:  
  if (client.connect(SERVER, 443)) {  
    Serial.println("connected to server");  
    // Make a HTTP request:  
    client.println("GET " PATH " HTTP/1.1");  
    client.println("Host: " SERVER);  
    client.println("Connection: close");  
    client.println();  
  }  
}  
  
uint32_t bytes = 0;  
  
void loop() {
```

```

// if there are incoming bytes available
// from the server, read them and print them:
while (client.available()) {
  char c = client.read();
  Serial.write(c);
  bytes++;
}

// if the server's disconnected, stop the client:
if (!client.connected()) {
  Serial.println();
  Serial.println("disconnecting from server.");
  client.stop();
  Serial.print("Read "); Serial.print(bytes); Serial.println(" bytes");

  // do nothing forevermore:
  while (true);
}

}

void printWifiStatus() {
  // print the SSID of the network you're attached to:
  Serial.print("SSID: ");
  Serial.println(WiFi.SSID());

  // print your board's IP address:
  IPAddress ip = WiFi.localIP();
  Serial.print("IP Address: ");
  Serial.println(ip);

  // print the received signal strength:
  long rssi = WiFi.RSSI();
  Serial.print("signal strength (RSSI):");
  Serial.print(rssi);
  Serial.println(" dBm");
}

```

As before, update the ssid and password first, then upload the example to your board.

Note we use `WiFiClientSecure client` instead of `WiFiClient client`; to require a SSL connection! This example will connect to a twitter server to download a JSON snippet that says how many followers adafruit has

```
Attempting to connect to SSID: Transit
.....
Connected to WiFi
SSID: Transit
IP Address: 192.168.1.182
signal strength (RSSI):-52 dBm

Starting connection to server...
connected to server
HTTP/1.1 200 OK
Accept-Ranges: bytes
Access-Control-Allow-Origin: platform.twitter.com
Access-Control-Allow-Methods: GET
Age: 12
cache-control: must-revalidate, max-age=600
content-disposition: attachment; filename=json.json
Content-Type: application/json;charset=utf-8
Date: Wed, 11 Nov 2020 20:58:39 GMT
expires: Wed, 11 Nov 2020 21:08:39 GMT
Last-Modified: Wed, 11 Nov 2020 20:58:27 GMT
Server: ECS (agb/52BA)
strict-transport-security: max-age=631138519
timing-allow-origin: *
X-Cache: HIT
x-connection-hash: a50988a9020759ec70520caef6c38bcf
x-content-type-options: nosniff
x-frame-options: SAMEORIGIN
x-response-time: 12
x-transaction: 003d88570028acec
x-tw-cdn: VZ
x-tw-cdn: VZ
x-xss-protection: 0
Content-Length: 197
Connection: close

[{"following":false,"id":"20731304","screen_name":"adafruit","name":"adafruit industries"},
disconnecting from server.
Read 966 bytes
```

## JSON Parsing Demo

This example is a little more advanced - many sites will have API's that give you JSON data. We will build on the previous SSL example to connect to twitter and get that JSON data chunk

Then we'll use [ArduinoJSON \(\)](#) to convert that to a format we can use and then display that data on the serial port (which can then be re-directed to a display of some sort)

First up, [use the Library manager to install ArduinoJSON \(\)](#).

Then load the example JSONdemo by copying the code below and pasting it into your Arduino IDE.

```
// SPDX-FileCopyrightText: 2014 Benoit Blanchon
// SPDX-FileCopyrightText: 2014 Arturo Guadalupi
// SPDX-FileCopyrightText: 2020 Brent Rubell for Adafruit Industries
//
// SPDX-License-Identifier: MIT

/*
This example creates a client object that connects and transfers
data using always SSL, then shows how to parse a JSON document in an HTTP response.

It is compatible with the methods normally related to plain
connections, like client.connect(host, port).
```

Written by Arturo Guadalupi + Copyright Benoit Blanchon 2014-2019  
last revision November 2015

```
*/

#include <WiFiClientSecure.h>
#include <ArduinoJson.h>
#include <Wire.h>

// uncomment the next line if you have a 128x32 OLED on the I2C pins
// #define USE_OLED
// uncomment the next line to deep sleep between requests
// #define USE_DEEPSLEEP

#if defined(USE_OLED)
// Some boards have TWO I2C ports, how nifty. We should use the second one sometimes
#if defined(ARDUINO_ADAFRUIT_QTPY_ESP32S2) || \
    defined(ARDUINO_ADAFRUIT_QTPY_ESP32S3_NOPSRAM) || \
    defined(ARDUINO_ADAFRUIT_QTPY_ESP32_PICO)
    #define OLED_I2C_PORT &Wire1
#else
    #define OLED_I2C_PORT &Wire
#endif
    #include <Adafruit_SSD1306.h>
    Adafruit_SSD1306 display = Adafruit_SSD1306(128, 32, OLED_I2C_PORT);
#endif

// Enter your WiFi SSID and password
char ssid[] = "YOUR_SSID"; // your network SSID (name)
char pass[] = "YOUR_SSID_PASSWORD"; // your network password (use for WPA, or
use as key for WEP)
int keyIndex = 0; // your network key Index number (needed
only for WEP)

int status = WL_IDLE_STATUS;
// if you don't want to use DNS (and reduce your sketch size)
// use the numeric IP instead of the name for the server:
//IPAddress server(74,125,232,128); // numeric IP for Google (no DNS)

#define SERVER "cdn.syndication.twimg.com"
#define PATH "/widgets/followbutton/info.json?screen_names=adafruit"

void setup() {
    //Initialize serial and wait for port to open:
    Serial.begin(115200);

    // Connect to WPA/WPA2 network
    WiFi.begin(ssid, pass);

    #if defined(USE_OLED)
        setupI2C();
        delay(200); // wait for OLED to reset

        if(!display.begin(SSD1306_SWITCHCAPVCC, 0x3C)) { // Address 0x3C for 128x32
            Serial.println(F("SSD1306 allocation failed"));
            for(;;); // Don't proceed, loop forever
        }
        display.display();
        display.setTextSize(1);
        display.setTextColor(WHITE);
        display.clearDisplay();
        display.setCursor(0,0);
    #else
        // Don't wait for serial if we have an OLED
        while (!Serial) {
```

```

        // wait for serial port to connect. Needed for native USB port only
        delay(10);
    }
#endif
// attempt to connect to Wifi network:
Serial.print("Attempting to connect to SSID: ");
Serial.println(ssid);
#if defined(USE_OLED)
    display.clearDisplay(); display.setCursor(0,0);
    display.print("Connecting to SSID\n"); display.println(ssid);
    display.display();
#endif

while (WiFi.status() != WL_CONNECTED) {
    delay(500);
    Serial.print(".");
}

Serial.println("");
Serial.println("Connected to WiFi");

#if defined(USE_OLED)
    display.print("...OK!");
    display.display();
#endif

printWifiStatus();
}

uint32_t bytes = 0;

void loop() {
    WiFiClientSecure client;
    client.setInsecure(); // don't use a root cert

    Serial.println("\nStarting connection to server...");
    #if defined(USE_OLED)
        display.clearDisplay(); display.setCursor(0,0);
        display.print("Connecting to "); display.print(SERVER);
        display.display();
    #endif

    // if you get a connection, report back via serial:
    if (client.connect(SERVER, 443)) {
        Serial.println("connected to server");
        // Make a HTTP request:
        client.println("GET " PATH " HTTP/1.1");
        client.println("Host: " SERVER);
        client.println("Connection: close");
        client.println();
    }

    // Check HTTP status
    char status[32] = {0};
    client.readBytesUntil('\r', status, sizeof(status));
    if (strcmp(status, "HTTP/1.1 200 OK") != 0) {
        Serial.print(F("Unexpected response: "));
        Serial.println(status);
    }
    #if defined(USE_OLED)
        display.print("Connection failed, code: "); display.println(status);
        display.display();
    #endif

    return;
}

// wait until we get a double blank line
client.find("\r\n\r\n", 4);

```

```

// Allocate the JSON document
// Use arduinojson.org/v6/assistant to compute the capacity.
const size_t capacity = JSON_ARRAY_SIZE(1) + JSON_OBJECT_SIZE(8) + 200;
DynamicJsonDocument doc(capacity);

// Parse JSON object
DeserializationError error = deserializeJson(doc, client);
if (error) {
  Serial.print(F("deserializeJson() failed: "));
  Serial.println(error.c_str());
  return;
}

// Extract values
JsonObject root_0 = doc[0];
Serial.println(F("Response:"));
const char* root_0_screen_name = root_0["screen_name"];
long root_0_followers_count = root_0["followers_count"];

Serial.print("Twitter username: "); Serial.println(root_0_screen_name);
Serial.print("Twitter followers: "); Serial.println(root_0_followers_count);
#ifdef USE_OLED
  display.clearDisplay(); display.setCursor(0,0);
  display.setTextSize(2);
  display.println(root_0_screen_name);
  display.println(root_0_followers_count);
  display.display();
  display.setTextSize(1);
#endif

// Disconnect
client.stop();
delay(1000);

#ifdef USE_DEEPSLEEP
#ifdef USE_OLED
  display.clearDisplay();
  display.display();
#endif // OLED
#ifdef NEOPIXEL_POWER
  digitalWrite(NEOPIXEL_POWER, LOW); // off
#elif defined(NEOPIXEL_I2C_POWER)
  digitalWrite(NEOPIXEL_I2C_POWER, LOW); // off
#endif
  // wake up 1 second later and then go into deep sleep
  esp_sleep_enable_timer_wakeup(10 * 1000UL * 1000UL); // 10 sec
  esp_deep_sleep_start();
#else
  delay(10 * 1000);
#endif
}

void setupI2C() {
  #if defined(ARDUINO_ADAFRUIT_QTPY_ESP32S2) || \
  defined(ARDUINO_ADAFRUIT_QTPY_ESP32S3_NOPSRAM) || \
  defined(ARDUINO_ADAFRUIT_QTPY_ESP32_PICO)
  // ESP32 is kinda odd in that secondary ports must be manually
  // assigned their pins with setPins()!
  Wire1.setPins(SDA1, SCL1);
  #endif

  #if defined(NEOPIXEL_I2C_POWER)
  pinMode(NEOPIXEL_I2C_POWER, OUTPUT);
  digitalWrite(NEOPIXEL_I2C_POWER, HIGH); // on
  #endif

  #if defined(ARDUINO_ADAFRUIT_FEATHER_ESP32S2)
  // turn on the I2C power by setting pin to opposite of 'rest state'

```

```

pinMode(PIN_I2C_POWER, INPUT);
delay(1);
bool polarity = digitalRead(PIN_I2C_POWER);
pinMode(PIN_I2C_POWER, OUTPUT);
digitalWrite(PIN_I2C_POWER, !polarity);
#endif
}

void printWifiStatus() {
  // print the SSID of the network you're attached to:
  Serial.print("SSID: ");
  Serial.println(WiFi.SSID());

  // print your board's IP address:
  IPAddress ip = WiFi.localIP();
  Serial.print("IP Address: ");
  Serial.println(ip);

  // print the received signal strength:
  long rssi = WiFi.RSSI();
  Serial.print("signal strength (RSSI):");
  Serial.print(rssi);
  Serial.println(" dBm");
}

```

By default it will connect to to the Twitter banner image API, parse the username and followers, and display them.

```

Attempting to connect to SSID: Transit
.....
Connected to WiFi
SSID: Transit
IP Address: 192.168.1.182
signal strength (RSSI):-54 dBm

Starting connection to server...
connected to server
Response:
Twitter username: adafruit
Twitter followers: 176400

```

---

## Usage with Adafruit IO

The ESP32-S2/S3 is an affordable, all-in-one, option for connecting your projects to the internet [using our IoT platform, Adafruit IO \(\)](#).

- For more information and guides about Adafruit IO, check out the [Adafruit IO Basics Series. \(\)](#)



# Install Libraries

In the Arduino IDE, navigate to Sketch -> Include Library->Manage Libraries...

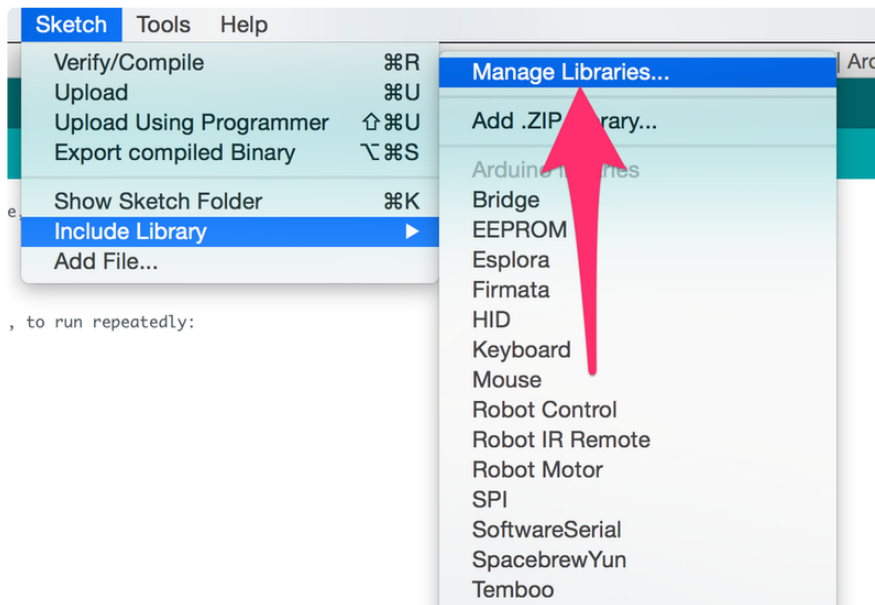

Enter Adafruit IO Arduino into the search box, and click Install on the Adafruit IO Arduino library option to install version 4.0.0 or higher.

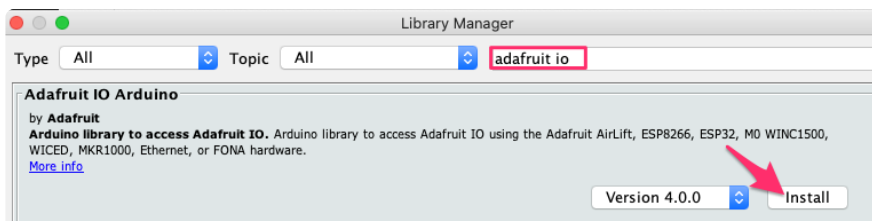

When asked to install dependencies, click Install all.

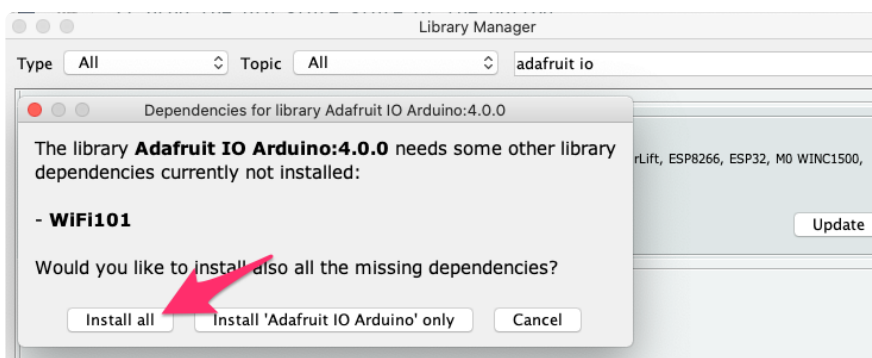

# Adafruit IO Setup

If you do not already have an Adafruit IO account, [create one now](#) (). Next, navigate to the Adafruit IO Dashboards page.

We'll create a dashboard to visualize and interact with the data being sent between your ESP32-S2/S3 board and Adafruit IO.

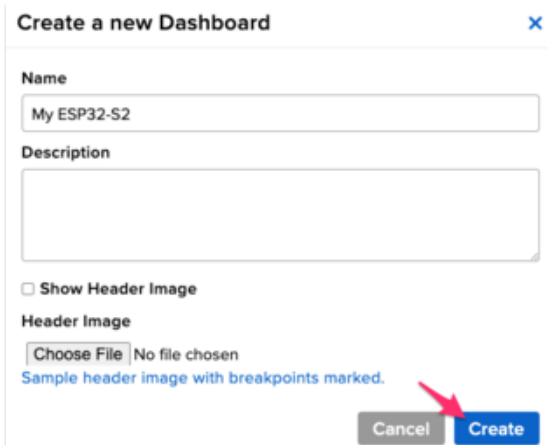
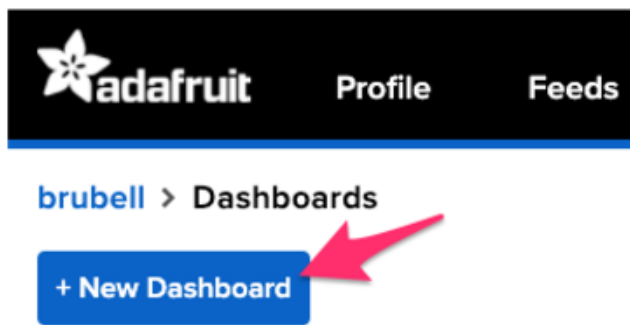
A screenshot of a modal form titled 'Create a new Dashboard'. The form has a close button (an 'x') in the top right corner. It contains the following fields and options: a 'Name' text input field with 'My ESP32-S2' entered; a 'Description' text area; a checkbox labeled 'Show Header Image' which is currently unchecked; a 'Header Image' section with a 'Choose File' button, the text 'No file chosen', and a link 'Sample header image with breakpoints marked.'; and at the bottom, two buttons: a grey 'Cancel' button and a blue 'Create' button. A red arrow points to the 'Create' button.

Click the New Dashboard button. Name your dashboard My ESP32-S2 or My ESP32-S3 depending on your board. Your new dashboard should appear in the list. Click the link to be brought to your new dashboard.

<input type="checkbox"/>	<a href="#">LoRa Feather Network</a>	lora-feather-network
<input type="checkbox"/>	<a href="#">My Air Quality Sensor</a>	my-air-quality-sensor
<input type="checkbox"/>	<b>My ESP32-S2</b>	my-esp32-s2
<input type="checkbox"/>	<a href="#">My Garage</a>	my-garage

We'll want to turn the board's LED on or off from Adafruit IO. To do this, we'll need to add a toggle button to our dashboard.

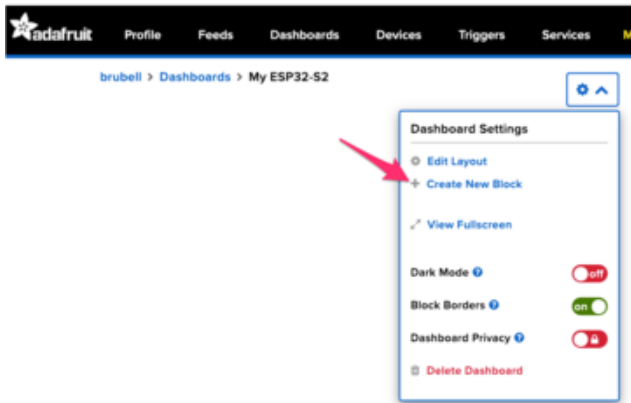

### Create a new block

Click on the block you would like to add to your dashboard. You can switch the block type later if you change your mind.

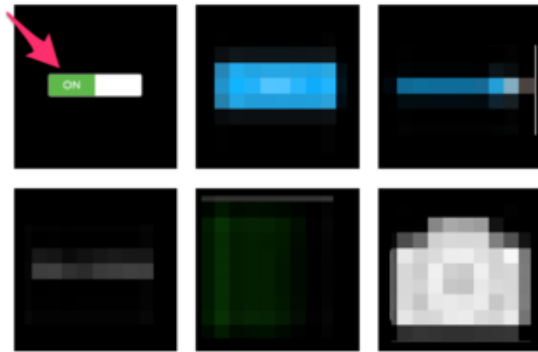

<input type="checkbox"/> led	HIGH	9 minutes
<input type="checkbox"/> lwill	rip	over 1 year
<input type="checkbox"/> moisture	2	1 day
<input type="checkbox"/> neopixel		2 days
<input type="checkbox"/> outdoor-lights	#000000	about 2 ye
<input type="checkbox"/> relay	morning	about 3 ho
<input type="checkbox"/> temperature	72	1 day
<input type="checkbox"/> test	66	2 days
<input type="checkbox"/> timecube	4.5	almost 2 ye
<input type="checkbox"/> zapemail	Gary Thompson...	1 day

led

Click the cog at the top right hand corner of your dashboard.

In the dashboard settings dropdown, click Create New Block.

Select the toggle block.

Under My Feeds, enter led as a feed name. Click Create.

Choose the led feed to connect it to the toggle block. Click Next step.

My Feeds		
Feed Name	Last value	Recorded
<input type="checkbox"/> battery	55	1 day
<input type="checkbox"/> digital	1	about 17 hours
<input type="checkbox"/> humidity	10	2 days
<input type="checkbox"/> image	/9j/4QAWRXhp...	5 months
<input type="checkbox"/> indoor-lights	#000000	about 2 years
<input checked="" type="checkbox"/> led		less than a min...
<input type="checkbox"/> lwill	rip	over 1 year
<input type="checkbox"/> moisture	2	1 day
<input type="checkbox"/> neopixel		2 days
<input type="checkbox"/> outdoor-lights	#000000	about 2 years

Block Title (optional)  
LED

Button On Text  
1

Button Off Text  
0

Block Preview



Toggle A toggle button is useful if you have an ON or OFF type of state. You can configure what values are sent on press and release.

Test Value  
45

Published Value

8 bytes

← Previous step Create block

Under Block Settings,

Change Button On Text to 1  
Change Button Off Text to 0  
Click Create block

adafruit Profile Feeds Dashboards Devices Triggers Services My Key

brubell > Dashboards > My ESP32-S2

LED



Next up, we'll want to display button press data from your board on Adafruit IO. To do this, we'll add a gauge block to the Adafruit IO dashboard. A gauge is a read only block type that shows a fixed range of values.

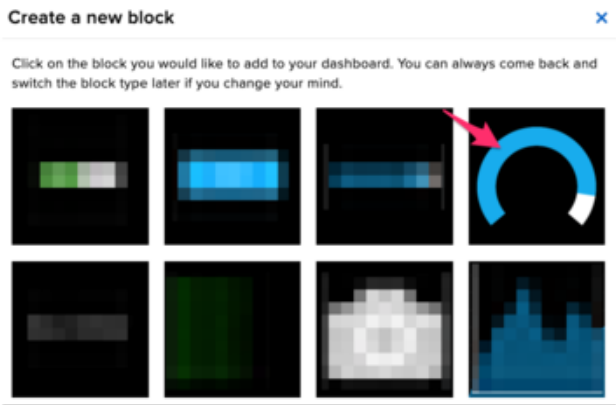

Block Name	Feed Name	Last Update	Lock Icon
<input type="checkbox"/> image	/9j/4QAWRXhp...	5 months	🔒
<input type="checkbox"/> indoor-lights	#000000	about 2 years	🔒
<input type="checkbox"/> led		16 minutes	🔒
<input type="checkbox"/> lwill	rip	over 1 year	🔒
<input type="checkbox"/> moisture	2	1 day	🔒
<input type="checkbox"/> neopixel		2 days	🔒
<input type="checkbox"/> outdoor-lights	#000000	about 2 years	🔒
<input type="checkbox"/> relay	morning	about 3 hours	🔒
<input type="checkbox"/> temperature	72	1 day	🔒
<input type="checkbox"/> test	66	2 days	🔒
<input type="checkbox"/> timecube	4.5	almost 2 years	🔒
<input type="checkbox"/> zapemail	Gary Thompson...	1 day	🔒
<input type="text" value="button"/>			

Click the cog at the top right hand corner of your dashboard.  
 In the dashboard settings dropdown, click Create New Block.  
 Select the gauge block.  
 Under My Feeds, enter button as a feed name.  
 Click Create.  
 Choose the button feed to connect it to the toggle block.  
 Click Next step.

### Create a Gauge Block

A gauge is a read only block type that shows a fixed range of values. Choose a single feed you would like to connect to this gauge feed within a group.

#### My Feeds

Feed Name	Last value
<input type="checkbox"/> battery	55
<input checked="" type="checkbox"/> button	

## Block settings



In this final step, you can give your block a title and see a preview of how it will look. Customize the look and feel of your block with the remaining settings. When you are ready, click the "Create Block" button to send it to your dashboard.

Block Title (optional)

Gauge Min Value

Gauge Max Value

Gauge Width

Gauge Label

Low Warning Value

Block Preview



Gauge A gauge is a read only block type that shows a fixed range of values.

Under block settings,

Change Block Title to Button Value

Change Gauge Min Value to 0, the button's state when it's off

Change Gauge Max Value to 1, the button's state when it's on

Click Create block

Your dashboard should look like the following:

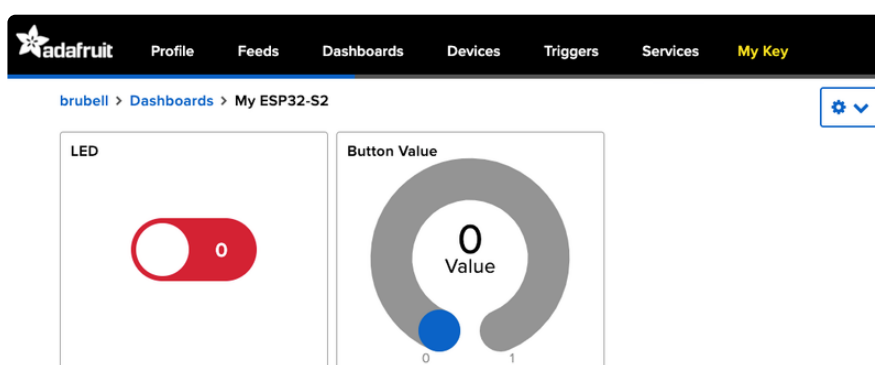

## Code Usage

For this example, you will need to open the `adafruitio_26_led_btn` example included with the Adafruit IO Arduino library. In the Arduino IDE, navigate to File -> Examples -> Adafruit IO Arduino -> `adafruitio_26_led_btn`.

Before uploading this code to the ESP32-S2/S3, you'll need to add your network and Adafruit IO credentials. Click on the `config.h` tab in the sketch.

Obtain your Adafruit IO Credentials from [navigating to io.adafruit.com](https://io.adafruit.com) and clicking [My Key \(\)](#). Copy and paste these credentials next to `IO_USERNAME` and `IO_KEY`.



```
adafruitio_26_led_btn - config.h | Arduino 1.8.13
adafruitio_26_led_btn config.h
1 /***** Adafruit IO Config *****/
2
3 // visit io.adafruit.com if you need to create an account,
4 // or if you need your Adafruit IO key.
5 #define IO_USERNAME "your_username"
6 #define IO_KEY "your_key"
7
```

Enter your network credentials next to `WIFI_SSID` and `WIFI_PASS`.

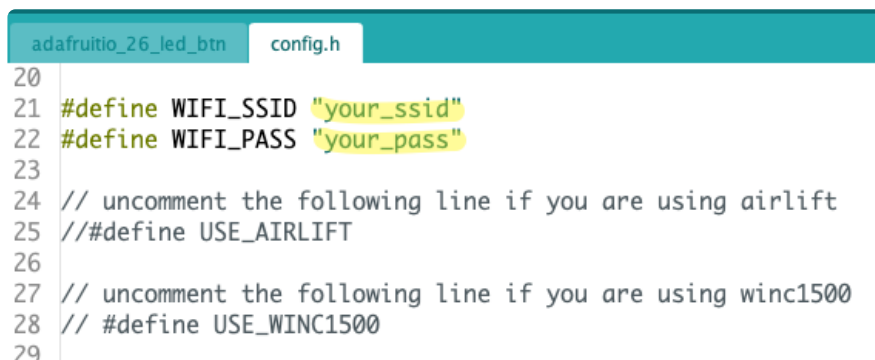

```
adafruitio_26_led_btn config.h
20
21 #define WIFI_SSID "your_ssid"
22 #define WIFI_PASS "your_pass"
23
24 // uncomment the following line if you are using airlift
25 //#define USE_AIRLIFT
26
27 // uncomment the following line if you are using winc1500
28 // #define USE_WINC1500
29
```

Click the Upload button to upload your sketch to the ESP32-S2/S3. After uploading, press the RESET button on your board to launch the sketch.

Open the Arduino Serial monitor and navigate to the Adafruit IO dashboard you created. You should see the gauge response to button press and the board's LED light up in response to the Toggle Switch block.

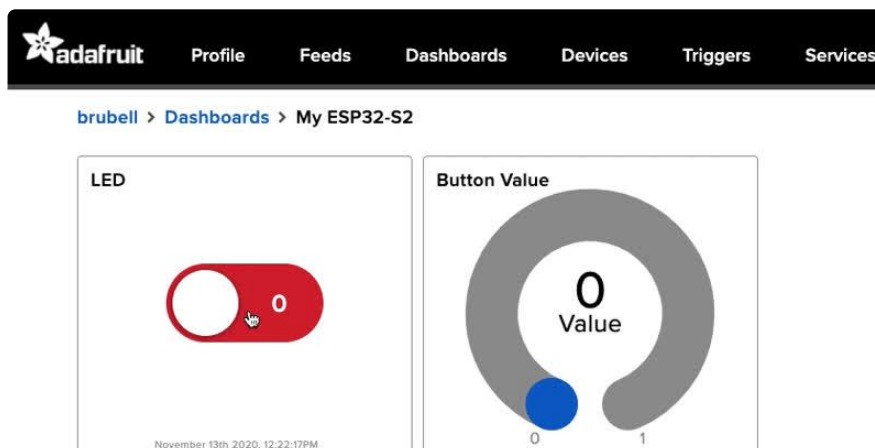

You should also see the ESP32-S2/S3's LED turning on and off when the LED is toggled:

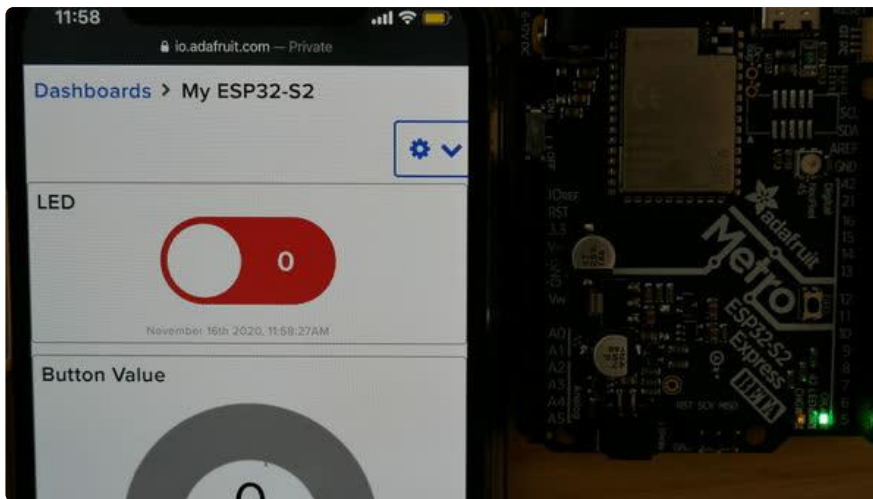

## Debugging with OpenOCD



It is possible to use a true step-and-memory debugger using OpenOCD - you will need an external debugger like a JLink or FT2232 JTAG adapter

You can use an OpenOCD compatible debugging probe such as J-Link for source level debugging of C and C++ code on the Adafruit Metro ESP32-S2. (However, I had more luck with a J-link BASE than a J-Link EDU Mini and more consistent behavior with the built in debugger of the Kaluga devkit than either)

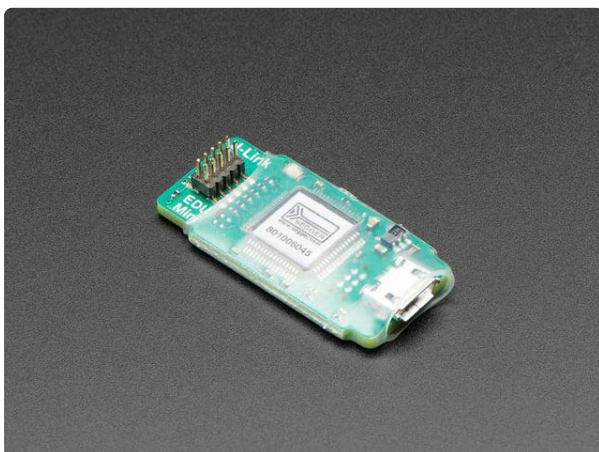

### [SEGGER J-Link EDU Mini - JTAG/SWD Debugger](#)

Doing some serious development on any ARM-based platform, and tired of 'printf' plus an LED to debug? A proper JTAG/SWD HW debugger can make debugging more of a pleasure and...

<https://www.adafruit.com/product/3571>



## Metro ESP32S2

First you'll need to solder on an SWD connector at the indicated location on the Metro ESP32-S2 PCB. Note that the "key" of the box header must be on the same side as the "pin 1" arrow. These are very fine pitch headers and can be difficult to solder. Any solder bridges between the pins will prevent the connection from working.

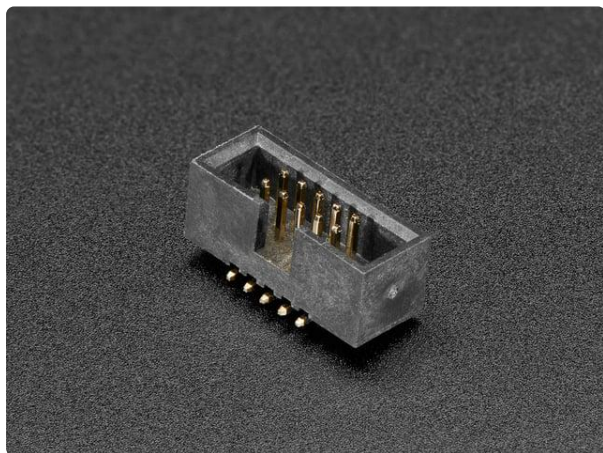

### [SWD 0.05" Pitch Connector - 10 Pin SMT Box Header](https://www.adafruit.com/product/752)

This 1.27mm pitch, 2x5 male SMT Box Header is the same one used on our SWD Cable Breakout Board. The header...

<https://www.adafruit.com/product/752>

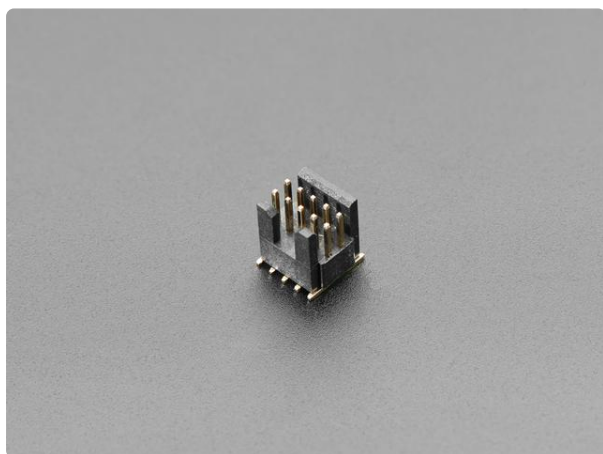

### [Mini SWD 0.05" Pitch Connector - 10 Pin SMT Box Header](https://www.adafruit.com/product/4048)

We've carrying a new 1.27mm pitch 2x5 Mini SWD 0.05" Pitch Connector. It's a tinier, bite-sized version of the

<https://www.adafruit.com/product/4048>

## OpenOCD Setup

Next, you'll need the version of the Open On-Chip Debugger (OpenOCD) updated with ESP32-S2 support by Espressif. If you have a CircuitPython build environment available, just use the `export.sh` from your CircuitPython source directory. Otherwise, you'll want to follow the [official installation instructions](#) () from Espressif.

Verify that you have Espressif's version of OpenOCD--just look for "esp32" in the version number, and make sure the date is at least as new as this one:

```
$ openocd --version
```

```
Open On-Chip Debugger v0.10.0-esp32-20200709 (2020-07-09-08:54)
```

You also need the correct debugger program, `xtensa-esp32s2-elf-gdb`, this version or newer:

```
$ xtensa-esp32s2-elf-gdb --version
```

```
GNU gdb (crosstool-NG esp-2020r3) 8.1.0.20180627-git
```

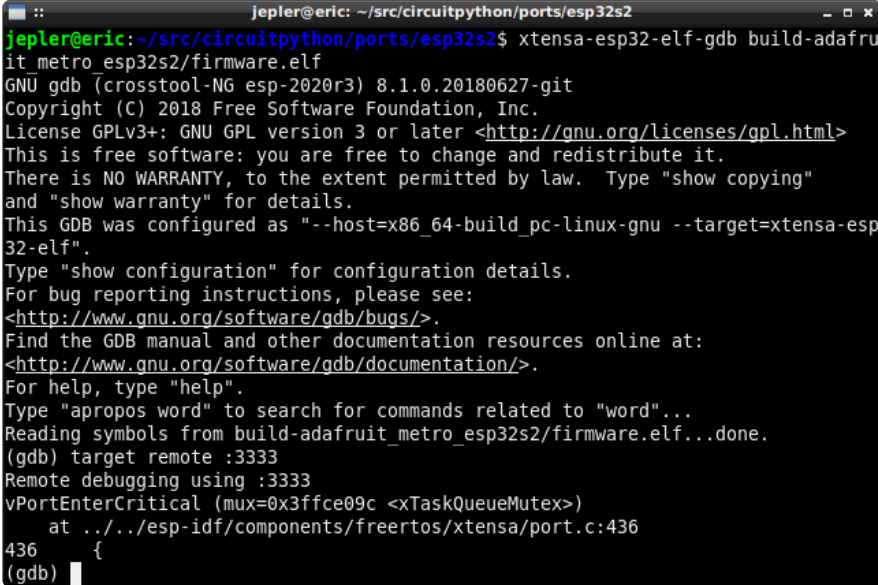

```
jepler@eric: ~/src/circuitpython/ports/esp32s2
jepler@eric:~/src/circuitpython/ports/esp32s2$ xtensa-esp32-elf-gdb build-adafruit_metro_esp32s2/firmware.elf
GNU gdb (crosstool-NG esp-2020r3) 8.1.0.20180627-git
Copyright (C) 2018 Free Software Foundation, Inc.
License GPLv3+: GNU GPL version 3 or later <http://gnu.org/licenses/gpl.html>
This is free software: you are free to change and redistribute it.
There is NO WARRANTY, to the extent permitted by law. Type "show copying"
and "show warranty" for details.
This GDB was configured as "--host=x86_64-build_pc-linux-gnu --target=xtensa-esp32-elf".
Type "show configuration" for configuration details.
For bug reporting instructions, please see:
<http://www.gnu.org/software/gdb/bugs/>.
Find the GDB manual and other documentation resources online at:
<http://www.gnu.org/software/gdb/documentation/>.
For help, type "help".
Type "apropos word" to search for commands related to "word"...
Reading symbols from build-adafruit_metro_esp32s2/firmware.elf...done.
(gdb) target remote :3333
Remote debugging using :3333
vPortEnterCritical (mux=0x3ffce09c <xTaskQueueMutex>)
   at ../../esp-idf/components/freertos/xtensa/port.c:436
436     {
(gdb)
```

In one terminal, start OpenOCD:

```
openocd -f 'interface/jlink.cfg' -f 'target/esp32s2.cfg' -c 'adapter_khz 2000'
```

In another terminal, start gdb and connect to OpenOCD:

```
$ xtensa-esp32s2-elf-gdb build-adafruit_metro_esp32s2/firmware.elf
(gdb) target remote :3333
Remote debugging using :3333
0x4001b800 in ?? ()
```

```
jepler@eric: ~/src/circuitpython/ports/esp32s2
jepler@eric:~/src/circuitpython/ports/esp32s2$ openocd -f 'interface/jlink.cfg'
-f 'target/esp32s2.cfg' -c 'adapter khz 2000'
Open On-Chip Debugger v0.10.0-esp32-20200709 (2020-07-09-08:54)
Licensed under GNU GPL v2
For bug reports, read
  http://openocd.org/doc/doxygen/bugs.html
adapter speed: 2000 kHz

Info : Listening on port 6666 for tcl connections
Info : Listening on port 4444 for telnet connections
Info : J-Link EDU Mini V1 compiled Aug 12 2019 10:38:48
Info : Hardware version: 1.00
Info : VTarget = 3.280 V
Info : clock speed 2000 kHz
Info : JTAG tap: esp32s2.cpu tap/device found: 0x120034e5 (mfg: 0x272 (Tensilica
), part: 0x2003, ver: 0x1)
Info : esp32s2: Debug controller 0 was reset.
Info : esp32s2: Core 0 was reset.
Info : Listening on port 3333 for gdb connections
```

I have not had success programming the chip using gdb commands like `load` or OpenOCD commands like `program_esp`. It's inconvenient but I still use esptool when reprogramming the chip.

---

## Downloads

Files:

- [ESP32-S2 product page with resources \(\)](#)
- [ESP32-S2 datasheet \(\)](#)
- [ESP32-S2 WROVER datasheet \(\)](#)
- [ESP32-S2 Technical Reference \(\)](#)
- [EagleCAD files on GitHub \(\)](#)
- [3D Models on GitHub \(\)](#)
- [Fritzing object in the Adafruit Fritzing Library \(\)](#)
- [PDF for Metro ESP32-S2 PrettyPins Diagram \(\)](#)

SVG for Metro ESP32-S2 PrettyPins  
Diagram

# Schematic and Fab Print

