

## Electrical Specifications

Input Voltage Range:	100-277 Vac Nom. (90-305 V Min/Max)
Input Over-Voltage:	Can endure 320Vac for 48 Hrs, 350Vac for 2 Hrs
Frequency:	50/60 Hz Nom. (47-63 Hz Min/Max)
Power Factor:	>0.90 @ 75-100% load, 100-277Vac
Inrush Current:	50A max @ 277V, 50% I <sub>peak</sub> = 750µsec, cold start 25°C
Input Current:	1.00 Amps max
Maximum Power:	75W
Current Regulation:	± 2% Over input line variation
Load Regulation:	± 3%
THD:	≤ 20% @ 60-100% load, 100-277Vac
Ripple & Noise: (Vpk-pk)	5% V <sub>o</sub> max @ 20 MHz BW, Full load output in parallel with 0.1 µF ceramic & 10 µF Electrolytic
Ripple: (Ipk-pk)	5% I <sub>o</sub> max @ 20 MHz BW, Full load output in parallel with 0.1 µF ceramic & 10 µF Electrolytic. 120 Hz component (Flicker Free)
Start-up Time:	200mS typical @ Full Load, 120Vac/60Hz (1000mS max)
Leakage Current:	0.28 mA max @ 120Vac, 0.78 mA max @ 277Vac
Hold Up Time:	40mS typical @ Full Load, 277Vac

## Protections

Over-voltage	Output
Over-current	Output
Short Circuit	Auto Recovery

## Environmental Specifications

Max Case Life Temp: (5 year warranty)	68°C
Maximum Case Temp (UL):	90°C
Minimum Starting Temp:	-30°C
UL Type TL Rating:	Class 2: 86/63°C; Non-Class 2: 90/81°C
Storage Temperature:	-40°C to +85°C
Humidity:	5% to 95%
Cooling:	Convection
Vibration Frequency:	5 to 55 Hz/2g, 30 minutes
Sound Rating:	Class A
Impact Resistance:	1g/s
MTBF:	474,000 Hours at full load and 40°C ambient conditions per MIL-217F Notice 2
EMC:	FCC 47CFR Part 15 Class B compliant
Weight:	19 oz. (538 g)

### Dimming Option:

“-D” 0-10V & Resistance dimmable models include an extra two wires +Purple/-Gray on the output side. “-D” Compatible with most quality 0-10V wall dimmers. See page 3.

“-D3” 3-wire dimmable model dims 100% to 10%. Three extra wires included on the output side: Yellow/Purple/Gray. This model is suitable for potentiometer dimming. See page 3.

### Note:

LED drivers are designed and intended to operate LED loads only. Non-LED loading may be outside the specified design limits of our LED drivers, and therefore cannot be covered by any warranty. If you desire to use our LED drivers to operate non-LED loads please contact us to discuss compatibility.



## Constant Current Models

Model	Output Current (mA ±3%)	Output Voltage Range (Vdc)	Max. Output Power (W)	Max Efficiency
PLED75W-214-C0350-XX	350	72-214	75	92%
PLED75W-166-C0450-XX	450	56-166	75	92%
PLED75W-108-C0530-XX	530	36-108	57.2	92%
PLED75W-108-C0700-XX	700	36-108	75	92%
PLED75W-072-C1050-XX	1050	24-72	75	91%
PLED75W-054-C1400-XX	1400	18-54	75	91%
PLED75W-048-C1560-XX	1560	16-48	75	90%
PLED75W-042-C1790-XX	1790	14-42	75	89%
PLED75W-036-C2100-XX	2100	12-36	75	89%
PLED75W-027-C2800-XX	2800	9-27	75	88%
PLED75W-024-C3130-XX	3130	8-24	75	88%
PLED75W-020-C3750-XX	3750	7-20	75	87%
PLED75W-015-C5000-XX	5000	5-15	75	86%
PLED75W-012-C6250-XX	6250	4-12	75	86%

-XX indicates dimming options are available. See options at left. Blank = fixed current output

## Constant Voltage Models

Model	Output Voltage (Vdc ±5%)	Output Current Range (mA)	Max. Output Power (W)	Max Efficiency
PLED75W-012 ●	12	1563-6250	75	86%
PLED75W-015	15	1250-5000	75	86%
PLED75W-020	20	938-3750	75	87%
PLED75W-024 ●	24	783-3130	75	88%
PLED75W-027	27	700-2800	75	88%
PLED75W-036	36	525-2100	75	89%
PLED75W-042	42	448-1790	75	89%
PLED75W-048	48	390-1560	75	90%
PLED75W-054	54	350-1400	75	91%
PLED75W-072	72	263-1050	75	91%
PLED75W-108	108	175-700	75	92%
PLED75W-166	166	113-450	75	92%
PLED75W-214	214	88-350	75	92%

- Smallest Footprint Driver for this wattage ● Indicates S.A.M.
- Total Power: 75 Watts
- Constant Current & Constant Voltage with Isolation
- Input Voltage: 100-277 Vac Nom.
- UL Dry & Damp Location Rated
- IP66 & NEMA6
- UL Type TL
- UL Type HL Rated for Hazardous Locations
- UL Sign Components Manual (S.A.M. Models)
- Black Magic Thermal Advantage™ Aluminum Housing

### Dimensions

IN [mm]

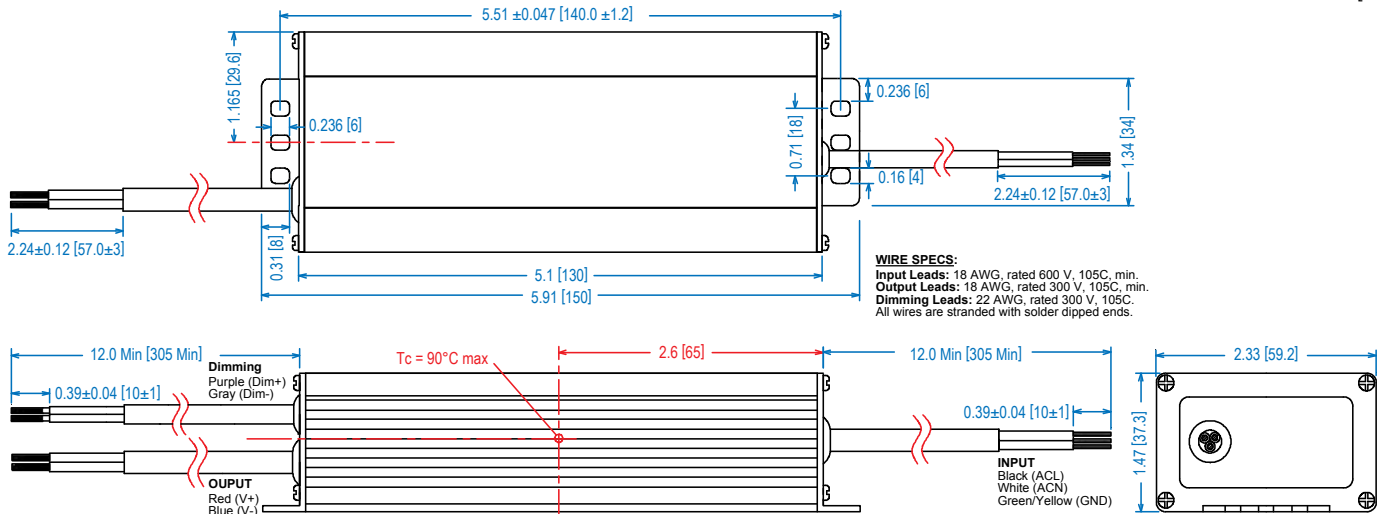

### Power Characteristics

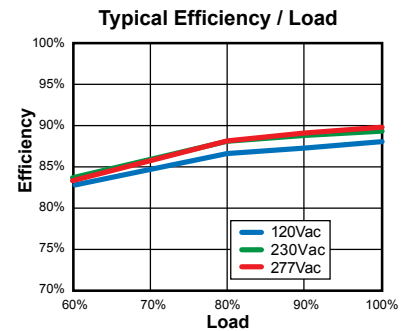
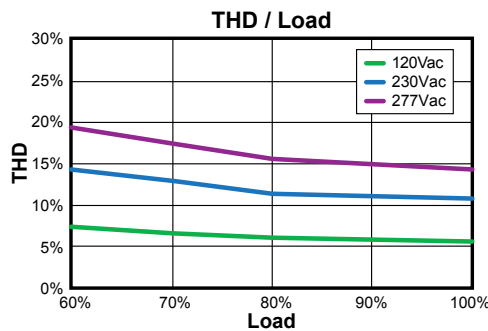
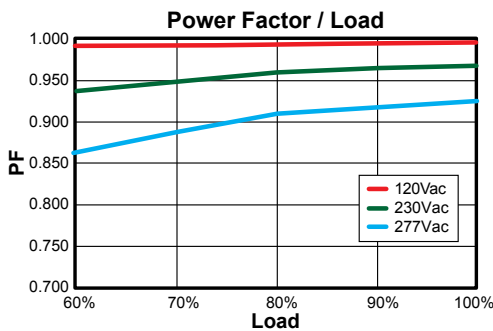

**Lifetime / Case Temperature**  
Full Load @ 120Vac

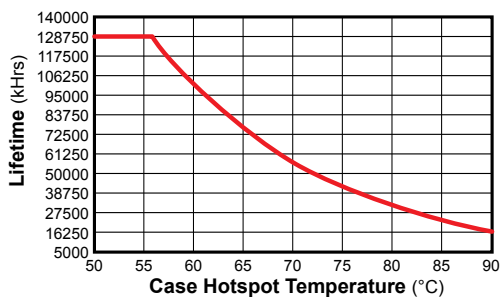

Safety Cert.	Standard
UL/CUL	UL8750 & CAN/CSA-22.2 No. 250.13-12, UL1310/CSA-C22.2 No.223-M91 for Class 2, UL1012/CSA-C22.2 No.107.1 for Non-Class 2
CE	EN 61347-1, EN61347-2-13
EMC Standard	Notes
FCC, 47CFR Part 15	Class B
EN 55015	Limits and methods of measurement of radio disturbance characteristics of electrical lighting and similar equipment.
EN 61000-3-2	Part 3-2: Limits for harmonic current emissions Class C, >80% Rated Power
EN 61000-3-3	Part 3-3: Limitation of voltage changes, voltage fluctuations and flicker.
EN 61000-4-5	Part 4-5: Surge Immunity test, 2 kV L-N, 4 kV L-G & N-G

### UL Conditions of Acceptability

See website for additional information

**Note:** The area under the life-temperature curve represents where the driver has highly reliable operation within specification. Driver performance may drift out of published specifications as the hours of operation exceed the curve at a given temperature. Higher operating temperatures increase the chances of a failure to function. Other electrical, mechanical and environmental factors affect driver lifetime but are not represented in this calculation.

**“-D” and “-D3” Options: 0-10VDC and Resistance Dimming**

Parameters	Minimum	Typical	Maximum
10V Output, Yellow Wire	9.2V	10.0V	10.8V
Source Current out of Aux Yellow Wire	---	---	10mA
Absolute Voltage Range on 0-10V (+) Purple Wire	-2.0V	---	+15V
Source Current out of 0-10V Purple Wire	0mA	---	2mA

**Typical Dimming Circuit**

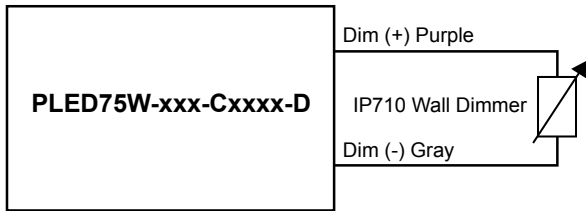

(Dimmer must be current-sink type control)

**3-Wire Dimming Typical Circuit**

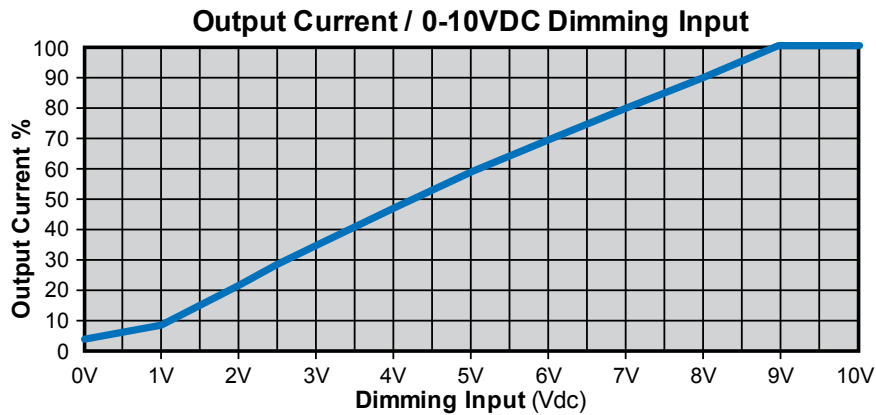
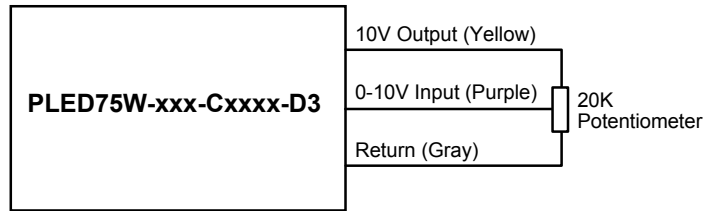

**Notes:**

- 0-10V dimmable version comes with an extra two wires +Purple/-Gray on the output side.
- Compatible with most 0-10V Wall Slide dimmers and direct 0-10V analog signal. Recommended dimmer is Leviton IP710 or equivalent
- 0-10V dimmable version is not intended to dim below about 5% @ 0V or 10% @ 1.0V
- 0-10V dimmable version output will be 100% with Purple/Gray open and minimum with Purple/Gray Shorted.
- 3-wire dimmable drivers come with three wires on the output side (Yellow/Purple/Gray).