

MODEL: UJ31-CH-G-SMT-TR-67 | DESCRIPTION: USB RECEPTACLE

FEATURES

- IP67 rated
- surface mount
- USB 3.1
- 10 Gbit/s data transfer speed
- reflow solder compatible



SPECIFICATIONS

parameter	conditions/description	min	typ	max	units
rated input voltage				20	Vdc
rated input current	as per EIA-364-70, Method B				
	power pins collectively (A4, A9, B4, B9)			5.0	A
	GND pins collectively (A1, A12, B1, B12)			1.25	A
	VCONN pins individually (A5, B5)			1.25	A
	all other signal pins individually			0.25	A
contact resistance ¹	between terminals and mating plug			40	mΩ
insulation resistance	between adjacent contacts	100			MΩ
voltage withstand	between adjacent contacts	100			Vac
insertion force	at a rate of 12.5 mm/min	5		20	N
withdrawal force	at a rate of 12.5 mm/min	8		20	N
life	at a rate of 500 ± 50 cycles per hour		10,000		cycles
operating temperature		-25		85	°C
flammability rating	UL94V-0				
RoHS	yes				
IP level	IP67				

Note: 1. When measured at 20 mV / 100 mA.
 2. All specifications measured at 10~35°C, humidity at 45~85%, under standard atmospheric pressure, unless otherwise noted.

SOLDERABILITY

parameter	conditions/description	min	typ	max	units
reel storage	at relative humidity <80%			40	°C
reflow soldering ³	see reflow profile	245	250	255	°C
drying conditions ⁴	parts in reel: bake at 40°C ±5°C for 72 hours parts removed from reel: bake at 40°C ±5°C for 10 hours				

Note: 3. It is recommended to reflow solder within 72 hours from opening vacuum packaging at a temperature <30°C & relative humidity <60%.
 4. When exceeding floor life by >72 hours.

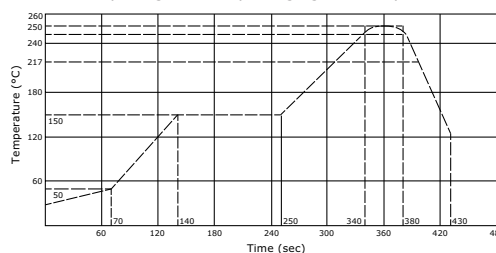

MECHANICAL DRAWING

units: mm
 tolerance:
 X.X ±0.20 mm
 X.XX ±0.10 mm
 X.XXX ±0.05 mm

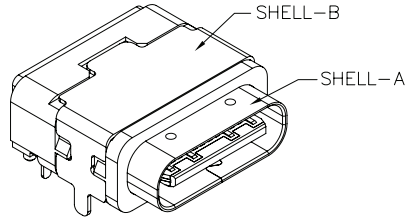

	MATERIAL	PLATING
contact terminals	copper alloy	nickel over all, gold flash on contact and solder area
shell-A	stainless steel	nickel
shell-B	brass	nickel
inner ground cover shell	stainless steel	
mid plate	stainless steel	nickel
insulator	PA10T	black
housing	PA10T	black
o-ring	silicone	

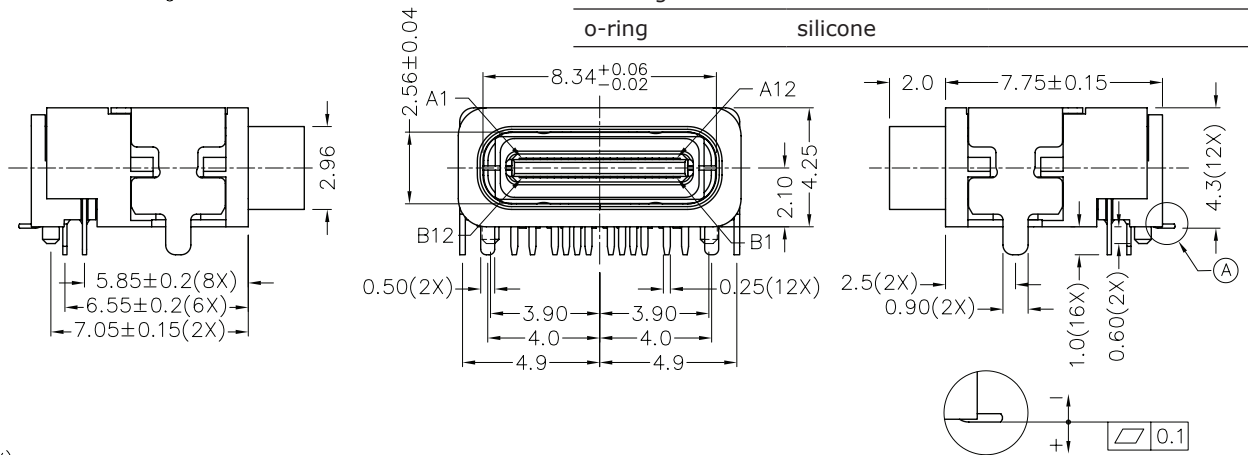

A DETAIL COPLANARITY

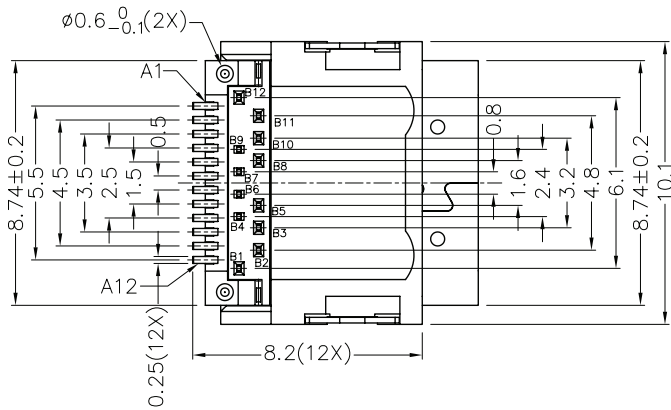

PIN NO.	A1	A2	A3	A4	A5	A6	A7	A8	A9	A10	A11	A12
	GND	TX1+	TX1-	Vbus	CC1	D+	D-	SBU1	Vbus	RX2-	RX2+	GND
PIN NO.	B12	B11	B10	B9	B8	B7	B6	B5	B4	B3	B2	B1
	GND	RX1+	RX1-	Vbus	SBU2	D-	D+	CC2	Vbus	TX2-	TX2+	GND

O-ring

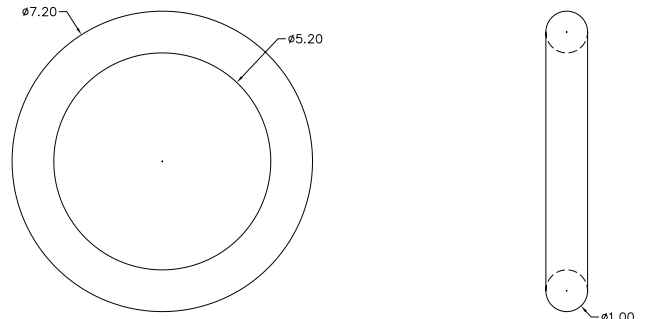

MECHANICAL DRAWING (CONTINUED)

units: mm
 PCB tolerance: ± 0.05 mm
 PCB thickness: 0.6~1.2 mm

PIN CONNECTIONS			
PIN	SIGNAL NAME	PIN	SIGNAL NAME
A1	GND	B12	GND
A2	TX1+	B11	RX1+
A3	TX1-	B10	RX1-
A4	V _{BUS}	B9	V _{BUS}
A5	CC1	B8	SBU2
A6	D+	B7	D-
A7	D-	B6	D+
A8	SBU1	B5	CC2
A9	V _{BUS}	B4	V _{BUS}
A10	RX2-	B3	TX2-
A11	RX2+	B2	TX2+
A12	GND	B1	GND

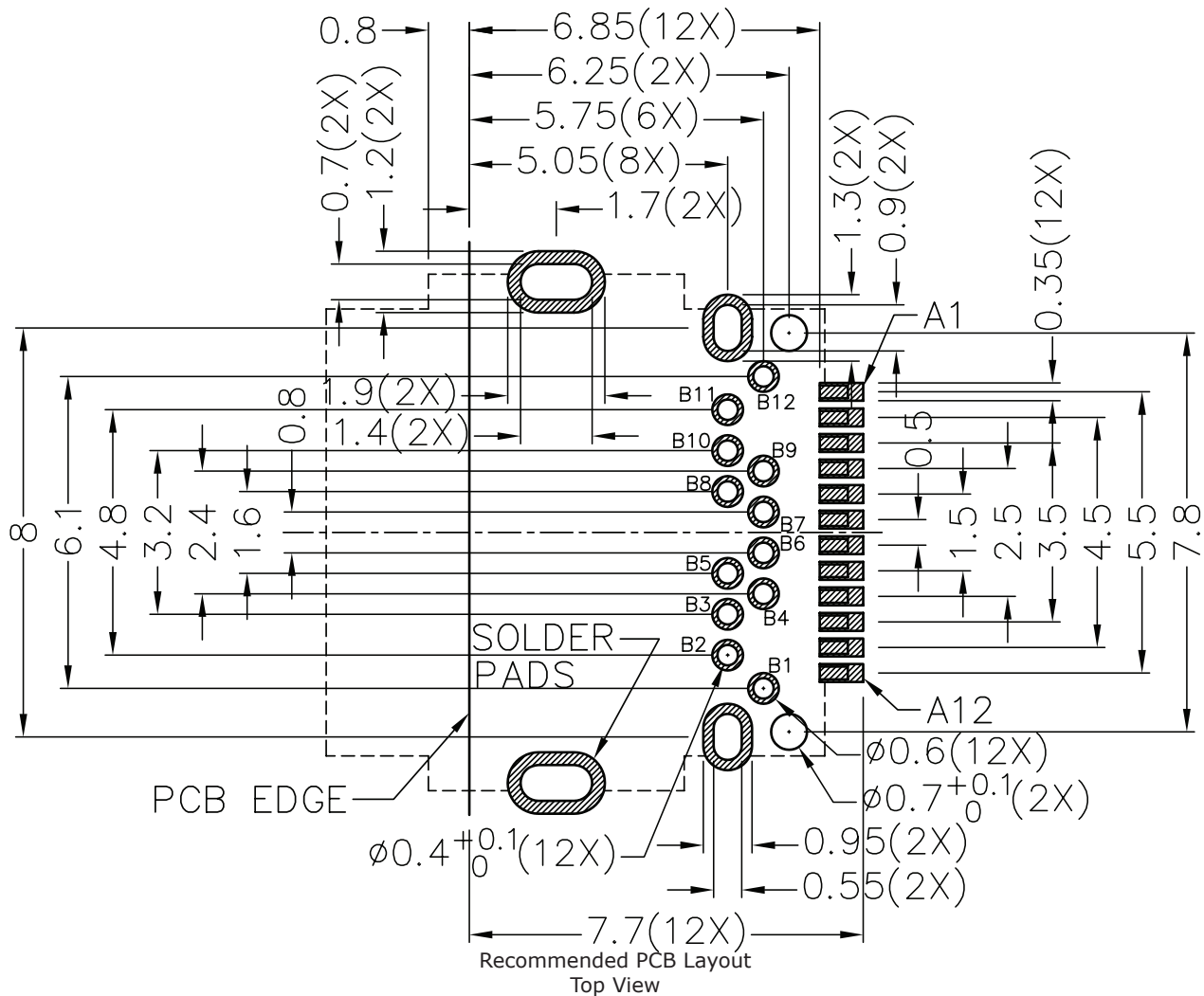

ASSEMBLY REFERENCE

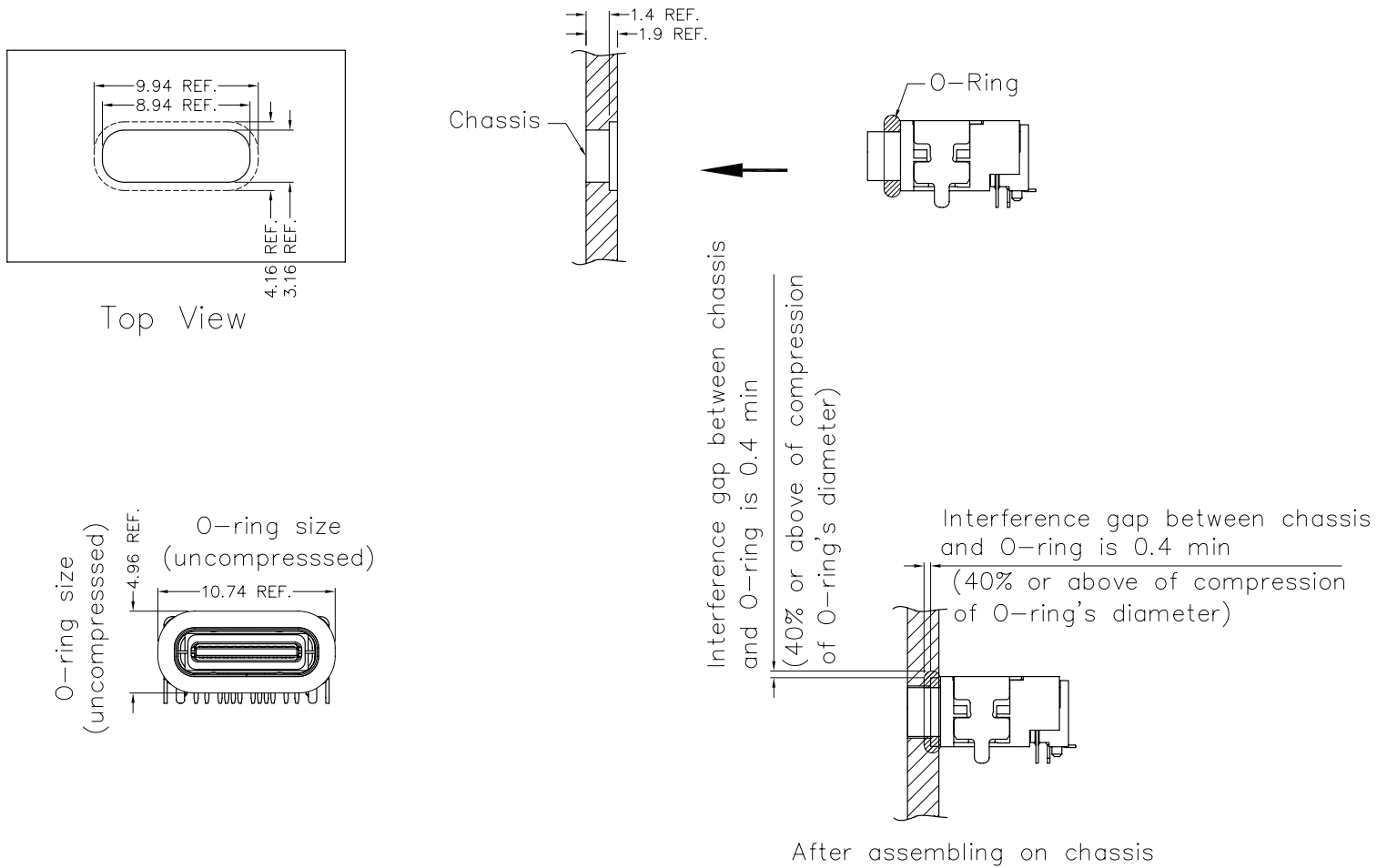

PACKAGING

units: mm

Reel Size: $\varnothing 381$ mm

Reel QTY: 900 pcs per reel

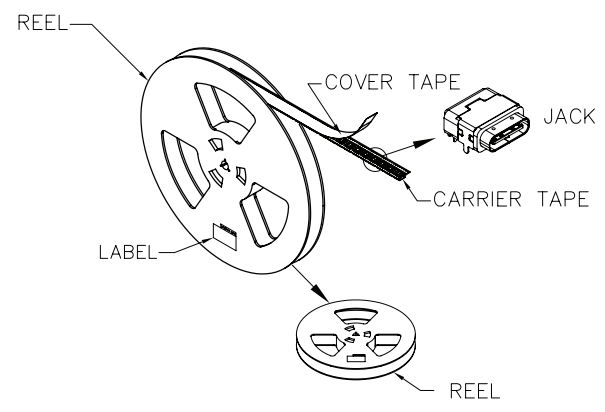
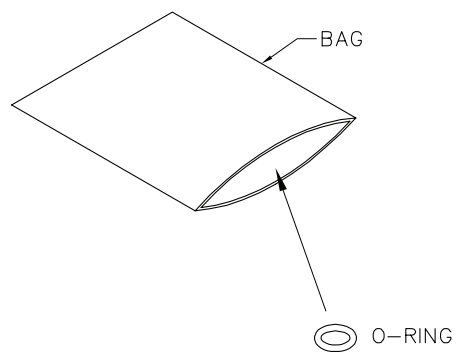
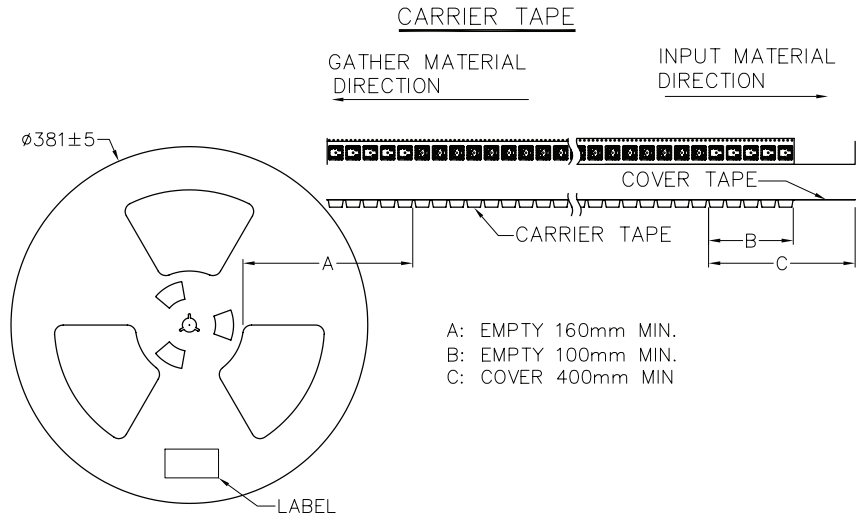
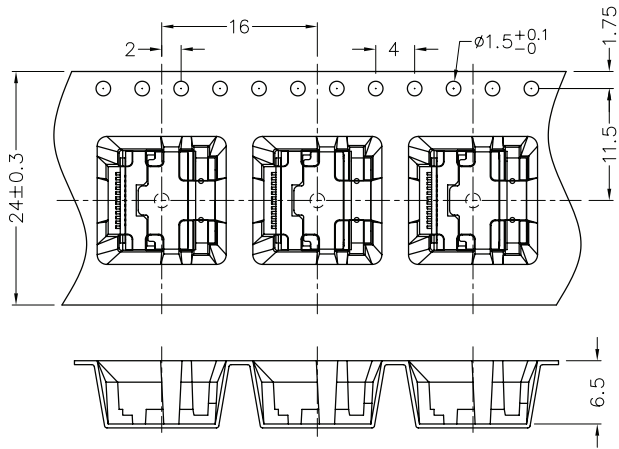

REVISION HISTORY

rev.	description	date
1.0	initial release	06/24/2020

The revision history provided is for informational purposes only and is believed to be accurate.

CUI DEVICES

CUI Devices offers a one (1) year limited warranty. Complete warranty information is listed on our website.

CUI Devices reserves the right to make changes to the product at any time without notice. Information provided by CUI Devices is believed to be accurate and reliable. However, no responsibility is assumed by CUI Devices for its use, nor for any infringements of patents or other rights of third parties which may result from its use.

CUI Devices products are not authorized or warranted for use as critical components in equipment that requires an extremely high level of reliability. A critical component is any component of a life support device or system whose failure to perform can be reasonably expected to cause the failure of the life support device or system, or to affect its safety or effectiveness.